

Inquiry 11-003: In-flight break-up ZK-HMU, Robinson R22,
near Mount Aspiring, 27 April 2011

The Transport Accident Investigation Commission is an independent Crown entity established to determine the circumstances and causes of accidents and incidents with a view to avoiding similar occurrences in the future. Accordingly it is inappropriate that reports should be used to assign fault or blame or determine liability, since neither the investigation nor the reporting process has been undertaken for that purpose.

The Commission may make recommendations to improve transport safety. The cost of implementing any recommendation must always be balanced against its benefits. Such analysis is a matter for the regulator and the industry.

These reports may be reprinted in whole or in part without charge, providing acknowledgement is made to the Transport Accident Investigation Commission.



Final Report

Aviation inquiry 11-003
In-flight break-up ZK-HMU, Robinson R22,
near Mount Aspiring,
27 April 2011

Approved for publication: February 2014

Transport Accident Investigation Commission

About the Transport Accident Investigation Commission

The Transport Accident Investigation Commission (Commission) is an independent Crown entity responsible for inquiring into maritime, aviation and rail accidents and incidents for New Zealand, and co-ordinating and co-operating with other accident investigation organisations overseas. The principal purpose of its inquiries is to determine the circumstances and causes of occurrences with a view to avoiding similar occurrences in the future. Its purpose is not to ascribe blame to any person or agency or to pursue (or to assist an agency to pursue) criminal, civil or regulatory action against a person or agency. The Commission carries out its purpose by informing members of the transport sector, both domestically and internationally, of the lessons that can be learnt from transport accidents and incidents.

Commissioners

Chief Commissioner	John Marshall, QC
Deputy Chief Commissioner	Helen Cull, QC

Key Commission personnel

Chief Executive	Lois Hutchinson
Chief Investigator of Accidents	Captain Tim Burfoot
Investigator in Charge	Ian McClelland
General Counsel	Rama Rewi/Cathryn Bridge

Email	inquiries@taic.org.nz
Web	www.taic.org.nz
Telephone	+ 64 4 473 3112 (24 hrs) or 0800 188 926
Fax	+ 64 4 499 1510
Address	Level 16, 80 The Terrace, PO Box 10 323, Wellington 6143, New Zealand

Important notes

Nature of the final report

This final report has not been prepared for the purpose of supporting any criminal, civil or regulatory action against any person or agency. The Transport Accident Investigation Commission Act 1990 makes this final report inadmissible as evidence in any proceedings with the exception of a Coroner's inquest.

Ownership of report

This report remains the intellectual property of the Transport Accident Investigation Commission.

This report may be reprinted in whole or in part without charge, provided that acknowledgement is made to the Transport Accident Investigation Commission.

Citations and referencing

Information derived from interviews during the Commission's inquiry into the occurrence is not cited in this final report. Documents that would normally be accessible to industry participants only and not discoverable under the Official Information Act 1980 have been referenced as footnotes only. Other documents referred to during the Commission's inquiry that are publicly available are cited.

Photographs, diagrams, pictures

Unless otherwise specified, photographs, diagrams and pictures included in this final report are provided by, and owned by, the Commission.



ZK-HMU
(Courtesy of Wanaka Helicopters Limited)

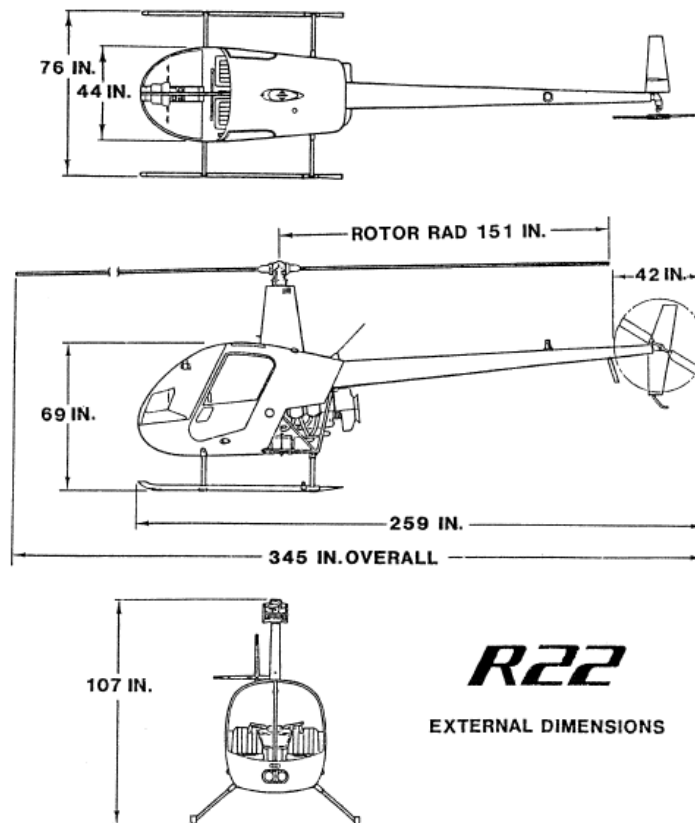

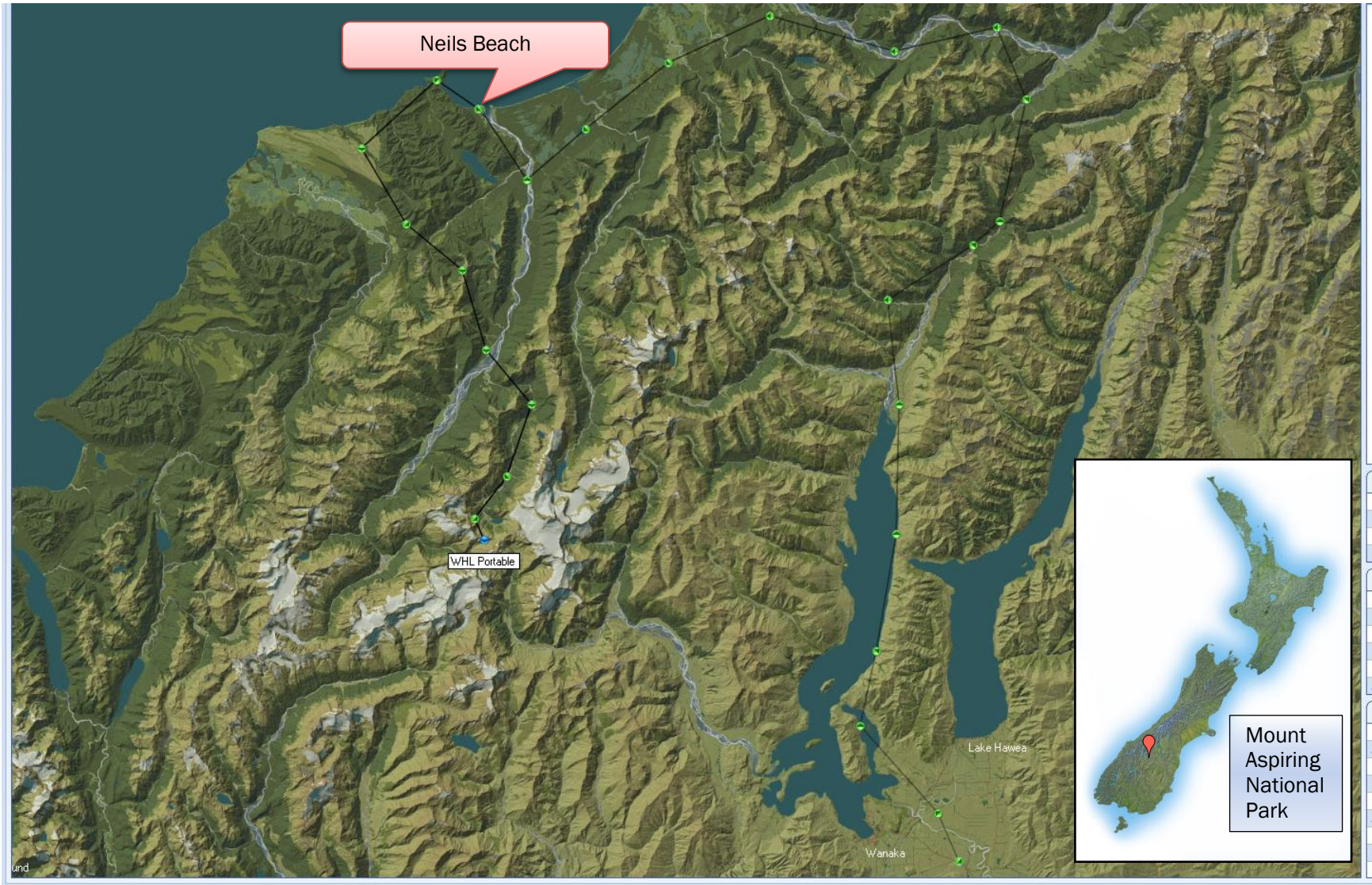

General location and flight path

Contents

- Abbreviations..... ii
- Glossary iii
- Data summary..... iv
- 1. Executive summary 1
- 2. Conduct of the inquiry..... 3
- 3. Factual information..... 4
 - 3.1. Narrative..... 4
 - 3.2. Aircraft information..... 7
 - 3.3. Site examination 9
 - 3.4. Personnel information 11
 - 3.5. Meteorological information 12
 - Weather information available to the pilots..... 12
- 4. Analysis..... 14
 - 4.1. Introduction..... 14
 - 4.2. What happened..... 14
 - The flight..... 14
 - Wreckage trail 17
 - Low-gravity flight 17
 - Turbulence 18
 - Large, abrupt control inputs..... 18
 - Low main rotor revolutions per minute 18
 - Likely sequence of events 19
 - 4.3. History of the R22 helicopter 20
 - Special safety awareness training..... 22
 - New Zealand response..... 23
 - The pilot-flying..... 23
 - The instructors 24
 - Flight manual (clarity of safety-critical information) 25
 - R22 safety performance (New Zealand) 27
 - 4.4. Locating aircraft..... 29
 - Emergency locator transmitters (ELT) 29
 - Flight tracking devices..... 29
- 5. Findings 31
- 6. Safety actions..... 32
 - General 32
 - Safety actions addressing safety issues identified during an inquiry..... 32
- 7. Recommendations..... 33
 - General 33
 - Recommendations..... 33
- 8. Key lessons..... 35
- 9. Works cited 36

Appendix 1: Comparison of USA and New Zealand Robinson helicopter requirements.....	37
Appendix 2: Weather forecasts	42
Area forecasts	42
Aerodrome forecasts.....	42
Aerodrome routine meteorological reports.....	43
MetService analysis charts.....	43
Appendix 3: R22 in-flight break-up accident reports	45
Appendix 4: R22 flight manual extract from “Limitations” section.....	47
Appendix 5: History of airworthiness directives and SFAR 73 in New Zealand.....	49
Appendix 6: The current version of SFAR 73.....	53
Appendix 7: Relevant Robinson Helicopter Company R22 safety notices	55
Appendix 8: Robinson R22 helicopter accident data comparison	57

Figures

- Figure 1 Flight path 6
- Figure 2 R22 rotor head control linkages (Image provided with permission by Burkhard Domke) 8
- Figure 3 Main rotor head assembly (from Robinson Helicopter Company)..... 8
- Figure 4 Mast bumping..... 9
- Figure 5 Wreckage spread..... 10
- Figure 6 Rotor head and teeter stops..... 11
- Figure 7 Approaching Matukituki Saddle towards the east (In an R44 2 days later. Courtesy of Wanaka Helicopters Limited) 16
- Figure 8 The tail boom impact lines..... 17
- Figure 9 R22 cyclic control 24

Abbreviations

AAIB	Air Accidents Investigation Branch (United Kingdom)
AD	airworthiness directive
ARFOR	area forecast
ATSB	Australian Transport Safety Bureau
CAA	Civil Aviation Authority of New Zealand
Commission	Transport Accident Investigation Commission
Cospas-Sarsat	Cosmicheskaya Sistyema Poiska Avariynich Sudov – Search and Rescue Satellite-Aided Tracking (international agreement between Russia, Canada, France and the United States of America)
ELT	emergency locator transmitter (aeronautical distress beacon)
FAA	Federal Aviation Administration (United States of America)
GPS	global positioning system
hPa	hectopascal(s)
km	kilometre(s)
km/h	kilometre(s) per hour
m	metre(s)
METAR	aerodrome routine meteorological report
NTSB	National Transportation Safety Board (United States of America)
RPM	revolution(s) per minute
SFAR	Special Federal Aviation Regulation
TAF	aerodrome forecast
UK	United Kingdom
USA	United States of America
UTC	co-ordinated universal time
Vne	velocity to never exceed

Glossary

Note: The rotor disc diagram and explanation in this glossary are from the Federal Aviation Administration's "Helicopter Flying Handbook".

flapping	the vertical movement of the main rotor blades around the hinge point at the coning bolt in the rotor head. When both blades flap upwards together, it is termed coning
low rotor RPM	a condition that occurs when the speed of the main rotor is allowed to decrease below its lower limit
mast bump	when the main rotor plane tilts in relation to the mast, beyond its physical limits, and the blade spindles contact the mast. The condition can lead to main rotor blade separation from the helicopter
main rotor divergence	where the main rotor blades become unstable in their normal rotor disc pattern due to abnormal conditions and diverge from the usual plane of rotation. The situation can lead to the main rotor blades striking the airframe
R22	2-seat model of Robinson helicopter
R44	4-seat model of Robinson helicopter
rotor disc	the imaginary disc swept by the main rotor blades as they rotate. It is a circle with its centre at the hub and a radius of one blade length. As the helicopter lifts off the ground the blade tips rise and this flat disc changes into an inverted cone shape

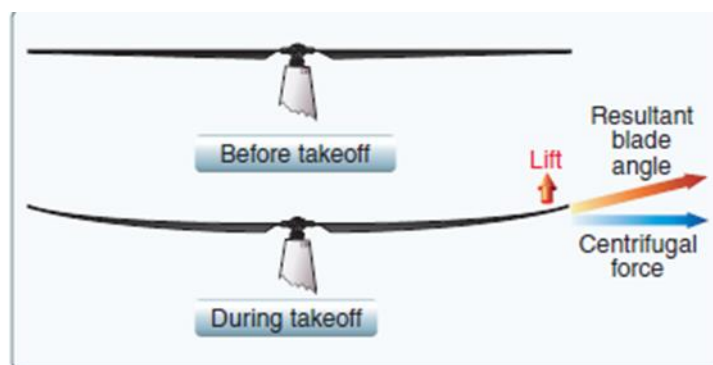

swashplate	the mechanical device on the main rotor mast that couples the pilot control movements to alter the pitch of the rotating main rotor blades
teeter	the tilting of the main rotor hub where it hinges on the teeter bolt

Data summary

Aircraft particulars

Aircraft registration:	ZK-HMU
Type and serial number:	Robinson R22 Beta II, Serial No. 3614
Number and type of engines:	one Lycoming, 4-cylinder horizontally opposed, Model O-360-J2A, Serial No. L-39550-36A
Year of manufacture:	2004. Total airframe time was 1300 hours
Operator:	Wanaka Helicopters Limited
Type of flight:	training
Persons on board:	2
Pilots' licences:	student: private pilot licence (helicopter), instructor: commercial pilot licence (helicopter)
Pilots' ages:	student: 21, instructor: 31
Pilots' total flying experience:	student: 90 hours, instructor: 1955 hours

Date and time 27 April 2011, 1232¹

Location Mount Aspiring National Park
latitude: 44° 24' 26.14" S
longitude: 168° 37' 39.46" E

Injuries 2 fatal

Damage aircraft destroyed

¹ All times stated in this report are in New Zealand Standard Time (NZST, which is UTC + 12 hours) and expressed in the 24-hour format.

1. Executive summary

- 1.1. On the morning of 27 April 2011, an instructor and a student pilot in a Robinson R22 helicopter departed from Wanaka Aerodrome on a cross-country training flight through part of the Southern Alps.
- 1.2. The weather for the trip was fine with a southeast wind blowing across the Southern Alps to the west. The wind was reported to be stronger than was indicated in the various aeronautical weather forecasts, at approximately 40 kilometres per hour (km/h), with gusts of up to 60 or 70 km/h over the mountain passes. The wind was causing turbulence on the leeward side of the mountains and passes, such as Matukituki Saddle.
- 1.3. The outward leg of the flight followed Lake Wanaka then travelled over Haast Pass to Neils Beach near the township of Haast. There the pilots refuelled the helicopter for the return leg, which was back to Wanaka via Matukituki Saddle near Mount Aspiring.
- 1.4. A flight-tracking device on the helicopter showed it climbing to approach Matukituki Saddle, but instead of passing over the saddle it turned right over the nearby Waipara Saddle into the Arawhata River valley. The helicopter was reported overdue later that afternoon. The wreckage of the helicopter was found the next day in the Arawhata River valley. Both pilots had died in the crash.
- 1.5. The wreckage revealed that the helicopter had broken up in flight. The Transport Accident Investigation Commission (Commission) determined that the helicopter had been operating in a high-risk situation at the time due to a combination of factors – at an altitude of about 5500 feet, close to its maximum permissible weight and entering an area of moderate to extreme turbulence.
- 1.6. The Commission determined that the in-flight break-up was caused by the main rotor blades deviating from their normal operating plane of rotation and striking the tail boom, causing a separation of the tail rotor assembly. This was likely to have been caused by one or a combination of the following conditions:
 - severe or extreme turbulence buffeting the helicopter
 - the main rotor speed being allowed to drop below its lower limit
 - the pilots making large and abrupt movements of the controls.
- 1.7. Safety issues identified include:
 - a lack of knowledge within the industry has led to the possibility that the instructor was not fully aware of the risks involved in flying the Robinson R22 helicopter near maximum weight at high altitude, and in moderate to severe turbulence
 - the format of the Robinson R22 helicopter flight manual and the terminology it uses do not draw appropriate attention to safety-critical instructions and conditions that could result in serious injury or death
 - the rate of R22 in-flight break-up accidents in New Zealand has not been significantly reduced by the New Zealand version of the Federal Aviation Administration (FAA) hazard mitigation measures intended to prevent such accidents.
- 1.8. A further but non-contributing safety issue was the crash survivability of emergency locator transmitters (ELTs), which automatically alert rescue co-ordination centres when an aircraft accident or incident has occurred.
- 1.9. The Commission made 2 [recommendations](#) to the Director of Civil Aviation to address the pilot and instructor ratings on Robinson helicopters, and a further 2 recommendations to support international efforts to improve the crashworthiness of ELTs and promote the use of alternative aircraft tracking systems to aid search and rescue efforts.

1.10. The **key lessons** from this investigation were:

- any aviation regulatory system must ensure that recommended and permissible maximum operating parameters for an aircraft type are clearly and consistently articulated to pilots, regardless of the country in which the aircraft is operated
- pilots must be fully aware of the operating limitations of aircraft they fly, and must always stay within those limitations.

2. Conduct of the inquiry

- 2.1. The Commission was notified of the overdue helicopter in Mount Aspiring National Park late afternoon on 27 April 2011. The wreckage was found the next morning. The Commission opened an inquiry under section 13(1) of the Transport Accident Investigation Commission Act 1990 later the same morning.
- 2.2. One investigator travelled from Christchurch to Wanaka on 28 April to liaise with Wanaka Police and another followed the next day from Wellington.
- 2.3. The Police, under the control of the local coroner, had removed the deceased from the scene on 28 April and transported them to the local morgue.
- 2.4. The site was examined on Friday 29 April by the 2 accident investigators with the assistance of 2 local helicopter operators and Wanaka Police. After gathering physical and photographic evidence, the available wreckage was collected and airlifted back to a road end. It was then trucked to a storage location at Wanaka Aerodrome before being moved to a Commission examination facility at Christchurch.
- 2.5. Interviews were conducted with the operator and with pilots who had been flying at the time of the accident, and with the people who were in last contact with the pilots. Further evidence was gathered from the operator.
- 2.6. As the investigation progressed it became evident that there were wider training issues for the helicopter than those immediately apparent. The accident was an in-flight break-up and another such R22 accident occurred near Wanaka in 2012 before this inquiry was complete. Soon after that, in 2013, a Robinson R66 helicopter near Taupo also appeared to have suffered a similar in-flight break-up. Finally, a serious incident occurred in New Plymouth in 2013. In this incident, an instructor in an R22 recovered from a training exercise during which the helicopter rolled more than 90°. The helicopter incurred damage to the mast but the pilots were not injured and the helicopter was repairable.
- 2.7. The Commission contacted the National Transportation Safety Board (NTSB) in the United States of America (USA) to seek liaison contacts with the FAA and Robinson Helicopter Company in the USA. The NTSB had also investigated many R22 accidents and the Commission sought its opinion and assistance.
- 2.8. An analysis of the evidence led the investigation to explore the regulatory environments in New Zealand and the USA. This culminated in an industry meeting in Wellington in 2013 between the Commission's investigators, the Civil Aviation Authority of New Zealand (CAA) and a group of experienced Robinson R22 instructors from around the country.
- 2.9. A draft report was submitted to the Commission for review on 25 September 2013.
- 2.10. The draft report was approved for distribution to interested persons on 20 November 2013. At the request of one of the interested persons, the opportunity to provide comment was extended to 7 February 2014. Two submissions were received: one from the operator and one from the CAA. Their submissions were considered and the report amended where appropriate. The other interested persons were contacted and declined to make any further comment.
- 2.11. The Commission approved the final report for publication on 26 February 2014.

3. Factual information

3.1. Narrative

- 3.1.1. At 0952 on 27 April 2011, an instructor and a student pilot in a Robinson R22 helicopter departed from Wanaka Aerodrome on a cross-country training flight through part of the Southern Alps. The helicopter registration was ZK-HMU and it was operated by Wanaka Helicopters Limited.
- 3.1.2. The flight was conducted under visual flight rules and generally followed the operator's standard training route (No.4) for commercial helicopter cross-country training. The outward leg ran approximately north from Wanaka aerodrome along the edge of Lake Wanaka, then followed State Highway 6 over Haast Pass to the township of Haast and finally Neils Beach. The return leg initially followed the Arawhata River, then travelled up the Waipara River to cross Matukituki Saddle by Mount Aspiring. From there the helicopter would have followed the Matukituki River West Branch back to Wanaka. The route was about 250 kilometres (km) (135 nautical miles) and would normally take at least 2 hours' flying time in ideal conditions.
- 3.1.3. The route was marked on the operator's flight planning board as "Wanaka – along lake – Haast – Jackson Bay – Aspiring – Wanaka" with an estimated arrival time back at Wanaka of 1200. A fuel endurance of 3 hours was also noted on the board.
- 3.1.4. The helicopter was equipped with a flight tracking device that sent a digital message via satellite back to a computer in the operator's office at Wanaka. The time-stamped digital message was transmitted every 5 minutes with the helicopter's identification, current position, altitude, ground speed and direction of travel.
- 3.1.5. The flight tracking log showed that the helicopter followed the outbound leg of the intended route through to Haast, then landed at Neils Beach airstrip in Jackson Bay at 1115 (about 35 km south of Haast). The weather conditions at Neils Beach were calm. The local helicopter operator based at Neils Beach spoke with the pilots. The pilots told the local helicopter operator that they had only expected 10 knots wind en-route but estimated it to have been closer to 30 knots. The instructor also told the local helicopter operator that they might have to divert on the way back due to the weather conditions. They said that they intended to fly up the Arawhata River (which meets the sea at Neils Beach).
- 3.1.6. The pilots loaded 40 litres of fuel provided by the local operator². The instructor also telephoned his base at Wanaka to extend the helicopter's estimated time of arrival to 1300.
- 3.1.7. The helicopter departed Neils Beach at 1145, but instead of following the Arawhata River it headed west towards Jackson Head. The flight tracking log showed that the helicopter flew south along the coast then turned inland above the Cascade River and continued east across the Arawhata River then south along the Waipara River.
- 3.1.8. Pilots broadcast regular radio position reports while operating in the Southern Alps so that other pilots in the area are aware of their intentions. The last radio position report broadcast from the helicopter was heard by the pilot of another aircraft in the area at about 1220. The pilot who responded recognised the instructor's voice. He said that the instructor did not sound concerned about the conditions and confirmed they were at 2000 feet and intending to cross Matukituki Saddle. The flight tracking log placed the helicopter in the Waipara River basin at that time.
- 3.1.9. The last flight tracking position report was received via satellite at 1230, placing the helicopter in the Arawhata River basin near Bow Peak at 5500 feet above mean sea level (see Figure 1, Position 1). This was an unexpected deviation from the intended flight path and showed that the helicopter had crossed Waipara Saddle rather than the intended Matukituki Saddle.

² The maximum fuel capacity was 113 litres, but with 2 pilots the maximum allowable fuel load was approximately 75 litres.

- 3.1.10. At about 1350, Wanaka Helicopters' operations staff noticed that the helicopter had not returned and initiated a local airport check to confirm that it was actually overdue. Wanaka Helicopters notified Rescue Coordination Centre New Zealand at 1508. By 1530 an official search and rescue operation was underway.
- 3.1.11. Helicopters were dispatched to search along the planned route and near the last known position report from the flight tracking device. The search carried on through the night to about 0400, then resumed at 0800 the same day. Occasional ELT signals were detected overnight near the crash site, but the search helicopters were unable to pinpoint the location.
- 3.1.12. The helicopter wreckage was found near the head of the Arawhata River at about 0900 on 28 April 2011. Both pilots had died in the crash.

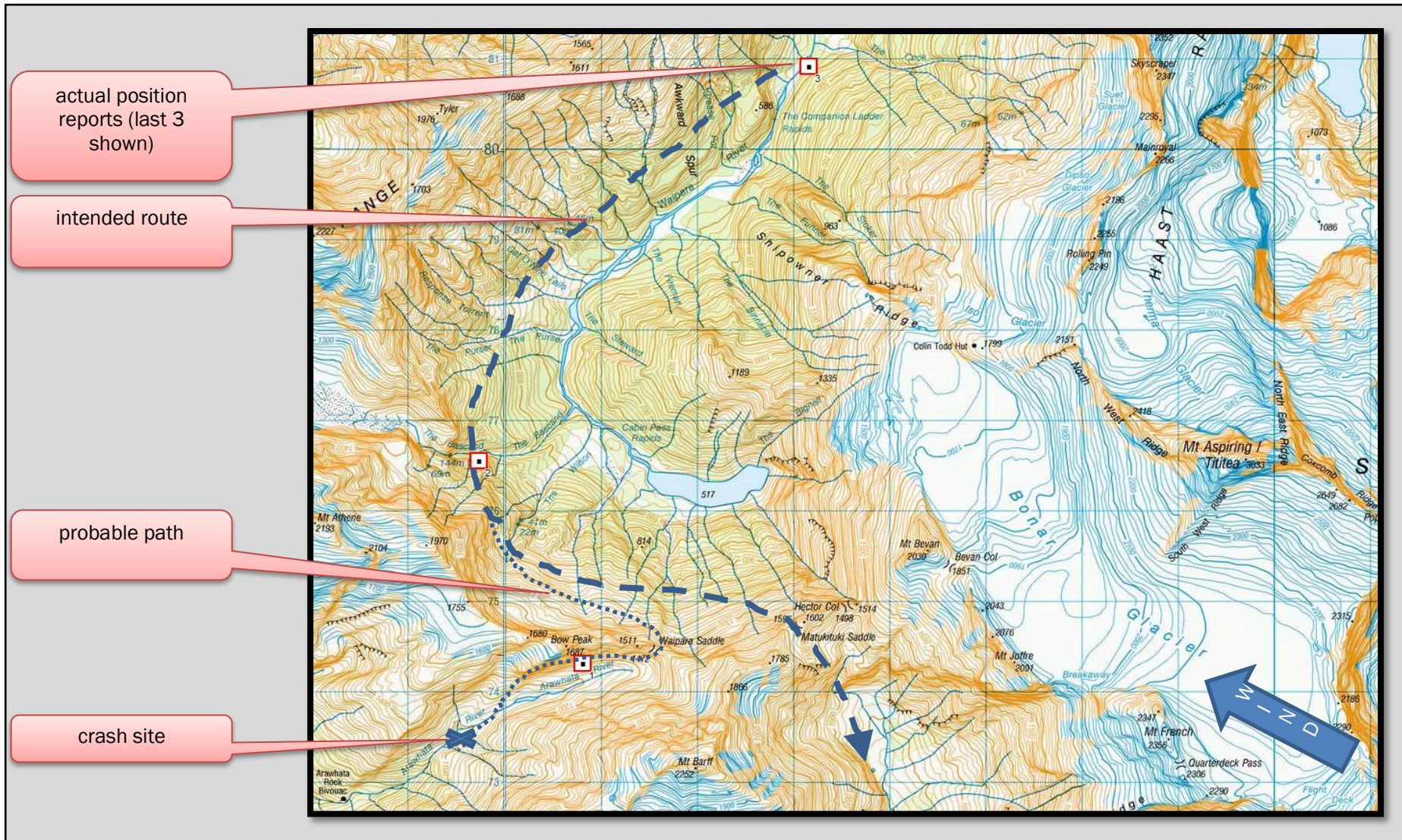

Figure 1
Flight path

3.2. Aircraft information

- 3.2.1. The Robinson R22 helicopter was designed as a 2-seat commuter aircraft for general use and entered production in 1979. In 1995 the FAA's Flight Standardization Board re-certified the R22 for general operations, including student training, private and commercial transport, agricultural work and external load operations.
- 3.2.2. The R22 flight manual additions by the FAA and CAA to the "Limitations" section prohibit flight in moderate, severe or extreme turbulence by pilots unless they meet certain flying experience thresholds³. Moderate turbulence is defined by the FAA and CAA as "Turbulence that causes changes in altitude or attitude; variations in indicated airspeed; and aircraft occupants to feel definite strains against their seat belts". The main reference to turbulence in the flight manual is the Robinson Safety Notice SN-32, which states that "turbulence should be avoided⁴", then explains what to do if turbulence is inadvertently encountered. A page inserted by the FAA to the "Emergency Procedures" section, which applies to all pilots, says that if a pilot has an "inadvertent encounter with moderate, severe or extreme turbulence" they are to "depart the area otherwise land the helicopter as soon as practical".
- 3.2.3. There were approximately 350 light helicopters operating in New Zealand in 2012 and 90% of them were either the Robinson R22 or R44⁵ type. The major use was for flight training but they were also used for scenic flights, aerial observation and photography, deer culling, stock mustering and private purposes.
- 3.2.4. This helicopter (ZK-HMU) had a current, non-terminating airworthiness certificate subject to it being maintained in accordance with its approved maintenance schedule. The most recent Review of Airworthiness had been completed on 23 December 2010 with no remarks or defects to be corrected. The next Review of Airworthiness was due on 22 December 2011.
- 3.2.5. The most recent maintenance check had been a 100-hour check completed at 1260.9 hours (airframe) on 30 March 2011 and the next check due was a 50-hour check at 1306.5 hours. The total aircraft time logged on the day before the accident was 1300 hours (airframe).
- 3.2.6. Figures 2 and 3 show how the main rotor blades are connected to the helicopter at the main rotor head assembly. The main rotor hub is attached to the main rotor shaft (mast) by the teeter bolt, which allows the main rotor hub and main rotor blades to tilt together. The 2 main rotor blades are attached (hinged) to the main rotor hub by coning bolts, which allow them to flap independently up and down on the rotor hub. The rotor hub and main rotor blades are said to rotate in a disc (the rotor disc). The direction of the helicopter is controlled by tilting the rotor disc forward, back, left or right from its usual position. The helicopter travels in the direction in which the disc is tilted.
- 3.2.7. The rotor disc is altered by the pilot using the cyclic and collective controls to alter the pitch angle of the main rotor blades. Through a system of control linkages the swashplate is moved vertically up and down or tilted. The movement of the swashplate adjusts the pitch of the main rotor blades through the pitch links. If the swashplate is moved vertically up or down, both main rotor blades receive an equal change in pitch and the helicopter rises or descends accordingly. If the swashplate is tilted the change in pitch is unequal, which causes the rotor disc to tilt and the helicopter to change direction accordingly.
- 3.2.8. If the helicopter encounters turbulence, the main rotor blades flap up or down to compensate for minor variations in the resultant aerodynamic forces. Normally the blades flap within their upper and lower limits. The upper limit is when the blade spindle contacts the up-coning stop. The lower limit is when the spindle tusk contacts the droop stop. If a main rotor blade pushes against either of these limit stops, this may influence the rotor disc to tilt further. If the main

³ The text added by the FAA and CAA says, "Continued flight in moderate, severe or extreme turbulence is prohibited".

⁴ Robinson Helicopter Company Safety Notice SN-32. See Appendix 7.

⁵ A Robinson 4-seat version of the R22 helicopter.

rotor disc tilts to the point where the rotor blade spindles contact the teeter stops, this is known as mast bumping.

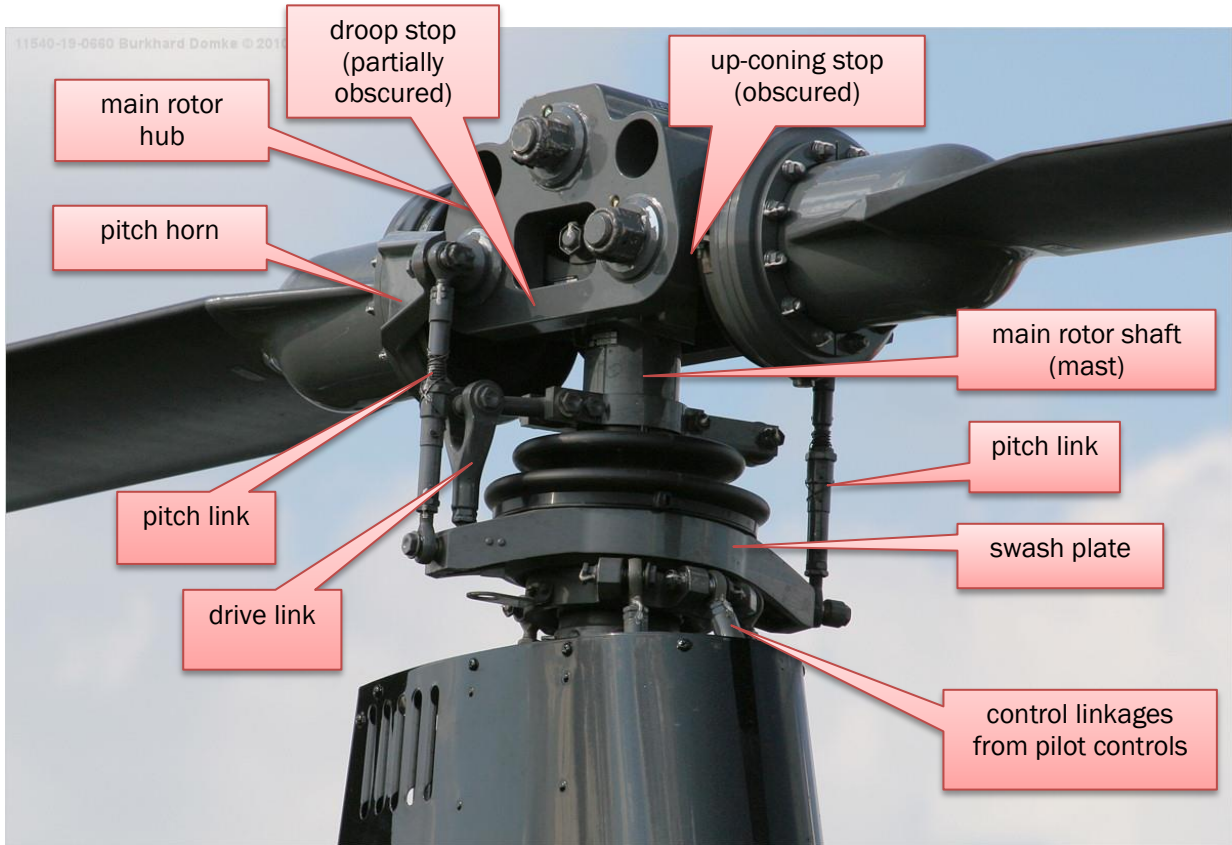

Figure 2
R22 rotor head control linkages
(Image provided with permission by Burkhard Domke)

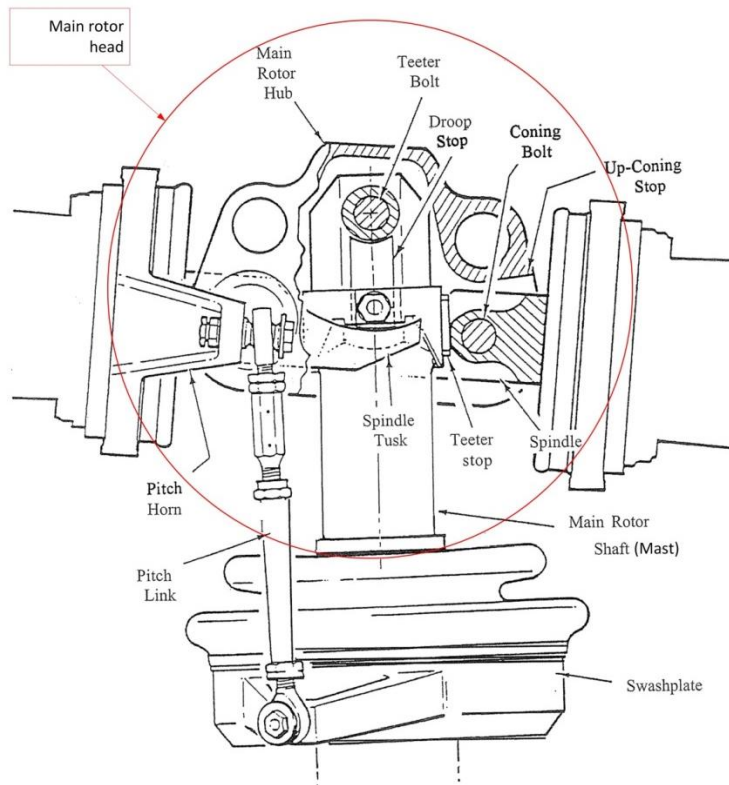

Figure 3
Main rotor head assembly
(from Robinson Helicopter Company)

- 3.2.9. Mast bumping occurs when the main rotor blade exceeds its flapping limits, causing the main rotor hub to “bump” into the main rotor shaft as shown in the diagram below⁶. The condition can lead to complete failure of the hollow main rotor shaft, resulting in the main rotor blade breaking away from the helicopter.

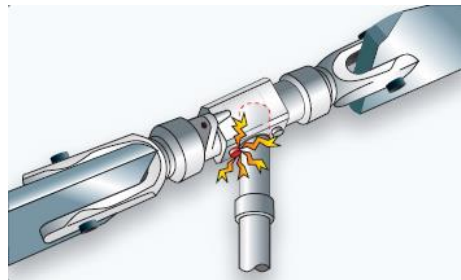

Figure 4
Mast bumping

3.3. Site examination

- 3.3.1. The main wreckage was located in a narrow, rocky stream bed, with most of the debris strewn 300 metres (m) back along the last known flight path from Waipara Saddle. The exception was the outer section of one main rotor blade, which was found about 50 m ahead of the main wreckage (see Figure 5). The impact damage indicated that the helicopter had struck a large boulder while in an upright position from a near-vertical trajectory. The fuel tanks had burst open upon impact, spilling aviation fuel around the area. There was no fire.
- 3.3.2. The wreckage trail began with the red-and-white tail rotor guard and part of the tail boom. These were found several metres apart about 300 m back from the main wreckage. The complete tail rotor assembly (including the tail fin) were found 145 m back from the main wreckage. Smaller Perspex fragments from the canopy and the red anti-collision beacon were found scattered along this first part of the wreckage trail.

⁶ From the FAA's "Helicopter Flying Handbook".



Figure 5
Wreckage spread

- 3.3.3. Both main rotor blades had fractured about 700 millimetres out from the hub. One blade had separated at that point and the outer section was found 50 m ahead of the main wreckage. The outer leading edge of both main rotors had paint transfer marks that matched the paint and impact impressions on the tail boom.
- 3.3.4. The upper and lower surfaces of both main rotor blades were creased. The creasing indicated that the main rotor blades had bent up and down vertically to the extent necessary to cause a permanent deformation of the surface skin. They also showed horizontal deformation, which is typically caused when the blades strike an object while the hub is still being driven.
- 3.3.5. One of the main rotor spindle tusks had bent outwards and scored the inside surface of the rotor head (visible in Figure 6). The up-coning stop surfaces both showed evidence of crush damage. Both teeter stops had been crushed by the blade spindle compressing against the main rotor shaft. These are typical indications that excessive rotor blade flapping and mast bumping had occurred.

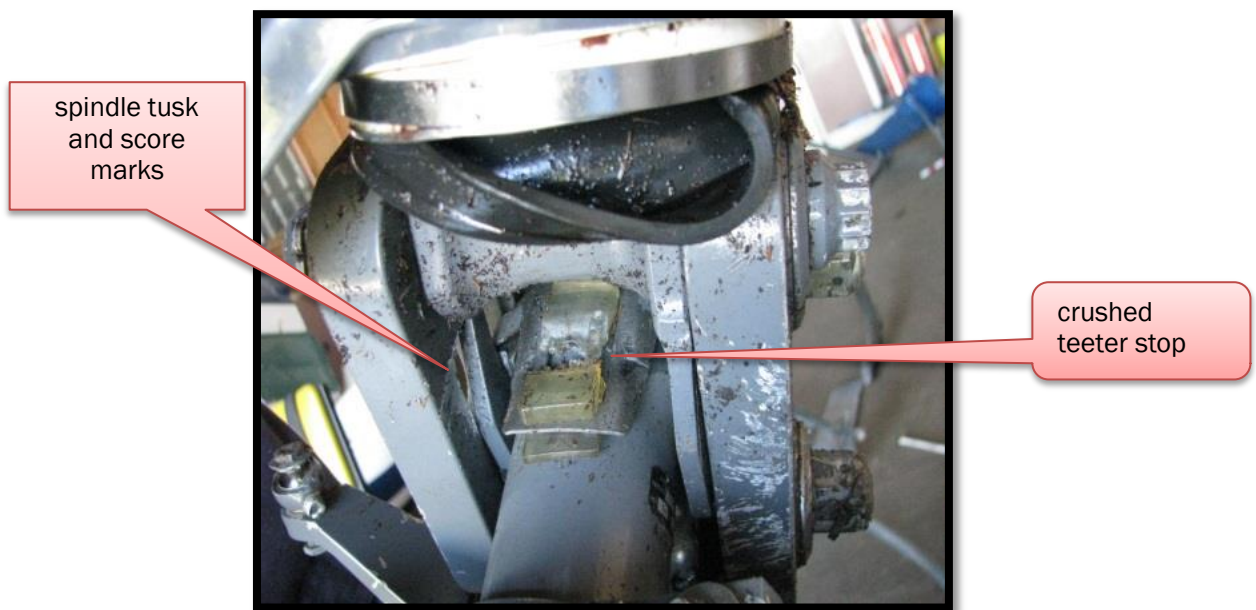

Figure 6
Rotor head and teeter stops

- 3.3.6. The 2 pitch links from the swashplate to the main rotor blade pitch horns and the swashplate drive link from the rotor shaft had snapped under tension at their narrowest diameter, in the trough of the adjustment thread. One pitch link had broken at both ends and was not found. The other pitch link had snapped at the main rotor blade pitch horn end but was still connected at the swashplate. The failure of the pitch links would have rendered the helicopter uncontrollable.

3.4. Personnel information

- 3.4.1. The autopsy reports identified that both pilots died from injuries sustained in the accident.
- 3.4.2. A toxicology analysis of blood samples taken from the pilots found no evidence of alcohol or performance-impairing substances. Blood carbon monoxide levels were consistent with normal levels observed in the general population.
- 3.4.3. The student pilot was training for his commercial licence. He was sitting in the right-hand seat where the pilot-flying would normally sit. He was 21 years old and held a current private pilot licence (helicopter) issued on 22 March 2011. He held a current Class 2 medical certificate. The student pilot had had 88 hours' total flying experience in R22 and R44 helicopters before the accident flight, including 23 hours on the type in the previous 30 days. He had satisfactorily completed both the ground and flight training parts of the Robinson safety

awareness training on 1 February 2011. He had also completed his mountain flying training to private pilot standard on 24 February 2011.

- 3.4.4. The instructor was 31 years old. He held a commercial pilot licence (helicopter), a Category B instructor's rating and a current Class 1 medical certificate. He had 1955 hours' total flying experience in helicopters, mostly in the R22 and R44 types. He had flown 1440 hours in the R22, of which 63 hours had been in the previous 30 days. A significant proportion of his total flying time had been in the mountainous area near Wanaka, including in the vicinity of the accident site.
- 3.4.5. The instructor had passed the Robinson safety awareness training for the ground and air components provided by Wanaka Helicopters on 28 April 2009. His Flight Crew Biennial Flight Review had been completed on 12 June 2009. His most recent Flight Crew Competency Check had been completed on 4 June 2010 and his "B" category Helicopter Instructor Renewal on 5 January 2011.
- 3.4.6. The operating company had internally rated the instructor as one of its category A pilots, which authorised him to run day-to-day company operations and oversee all other staff, including other instructors.

3.5. Meteorological information

- 3.5.1. A situation forecast map obtained from MetService after the accident showed an anticyclone centred over Tasmania moving towards New Zealand, with an associated cold front moving up towards the South Island from the Southern Ocean (see Appendix 2: Weather forecasts). There was a steep atmospheric pressure gradient across the South Island aligned north-south along the Southern Alps. The pressure gradient ranged from about 1033 hectopascals (hPa) on the eastern (Wanaka) side of the Southern Alps to 1024 hPa on the West Coast.
- 3.5.2. During the search for the overdue helicopter, Rescue Coordination Centre New Zealand requested a mountain forecast from MetService. The forecast for the Mount Aspiring area for 1830 on 27 April 2011 through to 0600 the next day said that southeast winds could be expected at 20 km/h gusting to 30 km/h and gradually easing overnight. The forecast also said that winds through the valleys and passes at about 500 m above sea level would be east to southeast at about 40 km/h, gusting to 60-70 km/h (22 knots gusting 32-38 knots).
- 3.5.3. The pilots of the search helicopters reported strong winds and associated turbulence in the search area during the afternoon and evening. The conditions were such that the movement of the helicopters was restricted in some locations. The winds abated during the night.

Weather information available to the pilots

- 3.5.4. MetService records showed that weather information had been downloaded by the operator at 0828, 0844 and 0906 on the day of the accident. This included area forecasts for the 3 meteorological areas that the flight would transit, aerodrome forecasts and aerodrome routine meteorological reports for Wanaka, Queenstown, Westport, Hokitika and Milford Sound.
- 3.5.5. The area forecast (ARFOR) valid to 1400 on the day of the accident for east of the Southern Alps predicted broken stratocumulus with a base at 4000 feet and tops around 6000 feet. The cloud base was expected to drop to 3000 feet on the west but tops remaining at 6000 feet. No significant weather, turbulence or ice was expected. Upper winds from 5000 feet to 10 000 feet on both sides of the Alps were from 120° True to 160° True, with corresponding wind speeds ranging from 5 to 10 knots on the eastern side and slightly higher on the western side, from 10 to 20 knots.
- 3.5.6. The applicable aerodrome forecast (TAF) expected the 2000-foot wind at Wanaka to be a 10-knot easterly. The same forecast for the West Coast aerodromes predicted 5- to 15-knot winds from the southeast.
- 3.5.7. In summary the reported mean sea-level air pressure was 10 hPa lower on the west side of the Southern Alps than on the east side. The wind was forecast to be stronger on the western

side of the ranges and more variable. The sky was generally clear but the broken cloud base could be below the tops of the mountains along the route.

4. Analysis

4.1. Introduction

- 4.1.1. The evidence from the accident site revealed that the helicopter had suffered an in-flight break-up. The wreckage trail was consistent with the tail rotor and another section of the tail boom having been severed by successive strikes of the main rotor blades. From that point the helicopter was uncontrollable, and the crash inevitable.
- 4.1.2. The damage observed in components making up the main rotor blade assembly revealed that the main rotor blades had flapped to extreme up and down angles against the physical stops and diverged from their normal plane of rotation to strike the tail boom⁷.
- 4.1.3. No evidence was found that a pre-existing mechanical condition contributed to the in-flight break-up. However, the high impact forces with the ground and resultant damage to the engine and its auxiliary components meant it was not possible to determine with any certainty how well the engine had been performing at the time of the in-flight break-up. The possibility of an engine problem having contributed to the accident could not therefore be excluded. No evidence was found of medical or toxicological factors having contributed to the accident.
- 4.1.4. Four safety issues arose out of this inquiry:
1. The New Zealand regulatory system has not provided sufficient mandatory requirements and guidance for instructors, pilots and operators of the Robinson type R22 and R44 helicopters to minimise the known risk of exceeding the helicopters' capabilities.
 2. The format of the Robinson R22 helicopter flight manual and the terminology it uses do not draw appropriate attention to safety-critical instructions and conditions that could result in serious injury or death.
 3. The rate of R22 in-flight break-up accidents in New Zealand has not been reduced by the New Zealand version of the FAA hazard mitigation measures intended to prevent such accidents.
 4. The crashworthiness of the ELT, which was designed to alert and guide emergency services to a crash site, was inadequate.

4.2. What happened

The flight

- 4.2.1. There was a significant difference in atmospheric pressure between Wanaka on the east side of the Southern Alps and the West Coast. Wind will generally flow from the higher-pressure area towards the lower pressure⁸. The general wind direction on the day of the accident was from east to west across the Southern Alps. This meant that the winds would be stronger across the mountain saddles and passes than at lower levels. A stronger wind in mountainous terrain means more turbulence.
- 4.2.2. Other local pilots had noted the pressure differential and several also commented that actual wind speeds were higher than those forecast.
- 4.2.3. The strength of the actual wind conditions high in the mountain passes was not immediately obvious from the aeronautical forecasts or from the conditions at Wanaka when the helicopter departed. The maximum forecast wind at 2000 feet was about 15 knots. Nevertheless, the instructor was experienced in mountain flying in the area and he had told the local helicopter operator at Neils Beach that the winds were stronger than he had expected for the outward

⁷ This type of accident cause is called "main rotor divergence" and "loss of control" in accordance with a standard taxonomy.

⁸ "Rule of thumb" – mountain flying training, and CAA publication "VFR Met" (CAA-2, 2010).

leg of the flight. He had also said that he was prepared to alter the return route if necessary. The instructor was therefore expecting strong wind and associated turbulence for the return leg to Wanaka.

- 4.2.4. The return leg from Neils Beach began with a diversion south to the Cascade River before intercepting the usual route up the Arawhata River and then up the Waipara River. The reason for this diversion could not be established. The subsequent track after this diversion was as expected.
- 4.2.5. The approach to Matukituki Saddle was into the wind. The standard technique for crossing a mountain saddle from a blind valley into the wind is to approach it on an angle from one side of the valley, thereby providing for an escape path away from the saddle and back down the valley. Ideally the escape path should result in the helicopter turning away from the terrain on the selected side of the valley and towards the direction from which the wind is coming, then to fly back down the same valley from where it has come (CAA, 2006). The flight tracking record showed the helicopter flying up the right-hand side of the Waipara River valley⁹. This was consistent with the standard technique for the wind conditions on the day. From that side of the valley the escape route would have been to turn left across the wind and reverse back down the Waipara River valley (see Figure 1).
- 4.2.6. Instead the helicopter crossed Waipara Saddle to the right (see Figure 7). It could not be determined with any certainty why this happened. The flight plan was to cross Matukituki Saddle, an area with which the instructor was familiar, and the pilots had reconfirmed this in their last radio position report, only about 10 minutes before the accident.
- 4.2.7. It is possible that the helicopter was forced across Waipara Saddle by a strong wind spilling over the saddle from the direction of Matukituki Saddle.
- 4.2.8. Five other helicopter pilots operating in the same area during that same afternoon reported strong winds from the east, and severe turbulence.
- 4.2.9. One pilot was flying a Hughes 369 helicopter in the area. He said that he passed over Arawhata Saddle (about 2 km from the accident site) about an hour after the accident. He described the turbulence along his route as being “pretty terrific”. He participated in the search later in the day and experienced severe turbulence near the south-eastern face of Bow Peak, near Waipara Saddle where the last flight tracking position report was recorded. The turbulence was so severe that it prevented him searching that area.
- 4.2.10. Another search pilot flew a Eurocopter EC130 over Matukituki Saddle about 3 hours after the accident. He found it too rough to remain in the area to the west of the saddle, so he flew over Waipara Saddle towards the last known position of the helicopter. He estimated the wind across Waipara Saddle into the Arawhata River basin to be 30 knots and experienced very rough turbulence as he flew past Bow Peak.

⁹ In the direction of flight.



Figure 7
Approaching Matukituki Saddle towards the east
(In an R44 2 days later. Courtesy of Wanaka Helicopters Limited)

Wreckage trail

4.2.11. The tail rotor section and another section of the tail boom were found near the start of the wreckage trail. This is almost certainly a sign that the tail boom was severed by the main rotor blades and is supported by the paint transfer marks from the tail boom found on both main rotor blades, the impact impressions on the tail boom and the fact that both main rotor blades were bent backwards in the horizontal plane. This rearward bending of the main rotor blades also supports a conclusion that the main rotor blades were being driven at the time they struck the tail boom, meaning the engine was probably still delivering power when the break-up sequence began. With the loss of the tail boom and rotor, the helicopter would have become instantly uncontrollable. Figure 8 shows the angle at which the main rotor blades would have diverged from the main rotor plane in order to strike the tail boom in this way.

4.2.12. There are several factors that can in combination cause main rotor divergence:

- low-gravity flight
- turbulence
- large, abrupt control movements by the pilots
- low main rotor revolutions per minute (RPM).



Figure 8
The tail boom impact lines

Low-gravity flight

4.2.13. Low-gravity flight is a situation when the occupants feel a sensation of weightlessness. It can be induced by the pilot performing a climb then suddenly pushing over into a dive or level flight. One possible result of low-gravity flight accidents is mast bumping¹⁰, and if the main

¹⁰ Mast bumping is where the main rotor blades flap beyond their normal limits and the blade spindles bump against the main rotor shaft (mast).

rotor blades strike the airframe, this is typically on the left side of the cabin¹¹. This did not happen in this case. Also, an examination of the mast under the crushed teeter stops showed that the mast bumping had not been severe enough to damage the mast. The evidence of mast bumping was limited to the teeter stops only. For these reasons, low-gravity flight was unlikely to have been the main factor contributing to the main rotor divergence. However, the possibility that it was a contributing factor due to turbulence cannot be excluded.

Turbulence

- 4.2.14. Turbulence is graded as light, moderate, severe or extreme. Light turbulence is when the turbulence causes slight erratic changes in attitude or altitude. At the other end of the scale, extreme turbulence is capable of structural damage. The grading is subjective and related to the weight of the aircraft. A pilot of a light helicopter may regard turbulence as moderate but a pilot in a commercial airliner may regard the same turbulence as light.
- 4.2.15. Flying in turbulence is a known contributor to main rotor divergence. A large gust downwards through the rotor disc can lead to unloading of the rotor blades, which can result in low-gravity flight. A large gust upward would load the rotor blades and increase the blade angle of attack¹¹. Either situation can be exacerbated if the pilot responds by over-controlling the helicopter in the turbulence, which can result in excessive blade flapping and lead to main rotor divergence. The helicopter was highly likely to have been in severe or extreme turbulence soon after crossing Waipara Saddle. Turbulence was likely to have been one of the main factors contributing to the in-flight break-up.

Large, abrupt control inputs

- 4.2.16. The R22 is very responsive to pilot movements on the controls, especially the cyclic control, and requires only light forces to achieve full control movement. A pilot who makes several consecutive large and abrupt control movements in either pitch or roll may cause the main rotor blades to flap excessively, which may lead to main rotor divergence. Pilot control movements may be accentuated in turbulence if the pilot tries to overcompensate for the external buffeting. The NTSB concluded in a study that “large and abrupt control inputs by the pilot can lead directly to mast bumping or induce blade stall, which in turn can lead to mast bumping” (NTSB, 1996).
- 4.2.17. It could not be determined which of the instructor or student pilot was flying the helicopter at the time of the in-flight break-up. The instructor had more experience flying the R22 helicopter so was likely to have been more capable in turbulent weather conditions than the student. If the student was flying the helicopter at the time, it is possible that over-controlling the helicopter could have occurred before the instructor had time to take over or limit the amount of control deflection in response to turbulence. The issue of regulatory requirements in New Zealand that govern when a pilot is allowed to manipulate the controls in R22 helicopters is discussed later in this report.

Low main rotor revolutions per minute

- 4.2.18. In normal flight the lift generated by the main rotor blades supports the weight of the helicopter. The centrifugal force applied to the main rotor blades from the speed of rotation balances the lift they also generate and prevents them bending upwards too far. If the rotational speed of the main rotor is allowed to reduce below the lower limit, the reduction in centrifugal force will no longer balance the lift, which will allow the blades to flap up excessively.
- 4.2.19. A secondary effect of low rotor RPM is “rotor stall”. This is when the angle of airflow across the rotor blade exceeds a critical value and the blade is no longer able to generate lift. Main rotor stall is unlikely to occur symmetrically, which can lead to main rotor divergence and the blades striking the airframe.

¹¹ Air Accidents Investigation Branch (AAIB, United Kingdom) Bulletin 2/2013, G-CHZN.

- 4.2.20. Engine failure or a partial loss of engine power may also cause a low rotor RPM situation if the pilot does not take appropriate action in time to maintain rotor RPM. A further cause can be when a pilot makes an excessive or abrupt upward movement on the collective control. This could cause the main rotor blades to over-pitch, and the resulting aerodynamic drag on the blades may exceed the available engine power. This is more likely to occur at higher altitude or when the helicopter is heavier, as was the case in this accident, because in these conditions the rotor blades are already operating at high pitch angles to generate the required thrust to keep the helicopter in the air.
- 4.2.21. The R22 at maximum fuel capacity has about 3 hours' flying endurance. However, with 2 average-weight¹² pilots it can only carry sufficient fuel for about 2 hours' endurance without exceeding the maximum permissible loading. The operator's practice at Wanaka was to fill both helicopter tanks partially, up to the hose nozzle (two-thirds capacity or about 70 litres) for dual cross-country flights, giving about 2 hours' flight duration. The fuel taken on at Wanaka before the flight was from an unmetred bulk tank. After flying to Neils Beach the pilots added another 40 litres of fuel (equivalent to one to 1.5 hours' flying time).
- 4.2.22. Assuming that the operator's standard practice had been followed, at the time of the accident the helicopter would have had sufficient fuel remaining for about 1.5 hours of flying. In this case it would have been just under the maximum permissible weight.
- 4.2.23. An inspection of the maintenance records for the helicopter revealed nothing of concern. The evidence indicated that the engine was delivering some power when the main rotor blades struck the tail boom. However, the damage to the engine and components caused by the ground impact precluded any meaningful post-accident performance testing of the engine. Therefore the possibility of a partial drop in engine performance contributing to main rotor RPM decay could not be excluded.

Likely sequence of events

- 4.2.24. The helicopter was flying above 5000 feet to cross Matukituki Saddle and it was close to its maximum permissible weight. It was therefore flying in conditions of reduced power margin. It was also flying into an area of moderate to extreme turbulence. The helicopter manufacturer recommended that strong winds or turbulence be avoided. Pilots who inadvertently encounter turbulence are recommended to maintain an average indicated airspeed of between 60 and 70 knots. They are also warned against over-controlling the helicopter in response to turbulence¹³.
- 4.2.25. As previously mentioned, it could not be established which of the pilots was manipulating the controls, but they would have experienced some degree of turbulence during the flight that day. If the student pilot with less R22 flying experience¹⁴ was manipulating the controls, the risk of over-controlling the helicopter in response to turbulence was higher¹⁵. However, the last recorded position of the helicopter and the wreckage trail showed that after deviating from the planned route and crossing Waipara Saddle, the helicopter travelled about one kilometre before the in-flight break-up began. If the instructor had had any concerns about the student's capability in turbulence there should have been ample time to take back the controls when they started to deviate from the planned route.
- 4.2.26. The risk of an in-flight break-up from a main rotor blade divergence event was high as the helicopter approached Matukituki Saddle. It was high due to the helicopter being near maximum weight and at a relatively high altitude, the strong wind, and flying in moderate to extreme turbulence. These conditions were challenging even for an experienced R22 pilot because they could in combination cause main rotor blade divergence, particularly if the pilot

¹² The operator used a standard weight allowance for an adult of 83 kilograms.

¹³ Robinson Helicopter Company safety notice issued in 1998 (SN-32).

¹⁴ This refers to the experience threshold flight hours set by the FAA in Special Federal Aviation Regulation 73 (Appendix 6).

¹⁵ The R22 is more responsive than other helicopters and special training is required (NTSB/SIR-96/03 findings 5 and 7, page 29).

responded with excessive movements of the cyclic control or an abrupt upward movement on the collective control.

4.2.27. The following evidence from the wreckage showed that the in-flight break-up was caused by main rotor divergence:

- the main rotor blades had flapped up and down to the limit stops and the blades had flexed beyond their normal flexible range, causing permanent creases on the upper and lower surfaces
- the main rotor hub had teetered beyond the design limit and crushed both teeter stops (mast bump)
- the 2 pitch links had snapped under tension at the blade pitch horn ends and the drive link had snapped at the swashplate end
- both main rotor blades had struck and separated the tail boom.

4.2.28. The flight up the Waipara River valley was consistent with the civil aviation guidelines for approaching and crossing mountain saddles. If something started to go wrong, the typical escape path should have been a left turn across the wind and a heading back down the river valley. Instead the helicopter travelled right, over Waipara Saddle and into an area of descending air and turbulence. This unexpected diversion from the intended route for the helicopter was unlikely to have been deliberate. The helicopter was possibly forced across Waipara Saddle by a strong cross-wind as it gained height to clear Matukituki Saddle, and the pilots possibly decided that the safer option was to turn with the wind and escape down the Arahata River valley instead.

Findings:

1. The helicopter was operating in conditions of reduced power margin where it was near to the maximum allowable weight, and flying at relatively high altitude in strong wind and moderate to extreme turbulence, at the time it broke up in flight.
2. The cause of the in-flight break-up was main rotor blade divergence caused by a possible combination of the following factors:
 - the helicopter entering low-gravity flight (more likely as a consequence of turbulence)
 - turbulence
 - excessive movements of the cyclic control
 - low main rotor blade RPM.
3. There was no evidence found that mechanical failure initiated the in-flight break-up, but the major damage to the engine and other components meant that the possibility of this could not be excluded.

4.3. History of the R22 helicopter

4.3.1. The circumstances of this in-flight break-up accident were not dissimilar to others involving R22 helicopters. The FAA first certified the R22 in 1979. In the following 15 years there were a number of fatal R22 crashes around the world, where helicopters had broken up in flight. Often the investigations were inconclusive or found no apparent causes, but there were some common failure modes. Either the main rotor had diverged from its normal plane to strike the tail boom or cockpit, or the drive shaft had severed, allowing the main rotor to detach completely from the helicopter.

- 4.3.2. These accidents prompted the FAA to conduct 3 Special Certification Reviews of the R22 in 1982, 1988 and 1994. The purpose of these reviews was to check that the helicopter complied with the certification requirements¹⁶. The review teams initiated some changes and raised some concerns. They expressed doubt about the validity of the FAA certification requirements for small helicopters and considered that the one-second pilot response time¹⁷ to certain events was too short, particularly for an aircraft used for training. Further research was recommended¹⁸.
- 4.3.3. A further review by the FAA Flight Standardization Board in 1995, convened to consider training requirements for R22 pilots, reported (FAA FSB, 1995):
- The Robinson R-22 has characteristics which makes awareness of certain aerodynamic factors mandatory. The awareness of low “G” operations, rotor blade stall potential, energy management, and low rotor RPM recovery techniques are critical.
- 4.3.4. This review report set out training and currency requirements for R22 pilots and instructors and suggested design changes deemed necessary for ensuring the safe operation of the R22. The report recommended that the Code of Federal Regulations (CFR) Part 27 be reviewed with regard to main rotor inertia in single-engine helicopters.
- 4.3.5. The NTSB was also concerned with the safety of the R22. Its concern was prompted by another fatal accident in 1992. The damage characteristics were similar to other main rotor blade divergence accidents. The pilot was an experienced R22 pilot and the accident occurred in apparently benign circumstances. The NTSB launched a special investigation (NTSB, 1996). The investigation researched 34 similar accidents involving R22 and R44 helicopters.
- 4.3.6. During the 4-year investigation, the NTSB issued 11 safety recommendations to the FAA. Some of these initial safety recommendations required immediate action and other recommendations called for further testing to gain a better understanding of the rotor system dynamics. All 11 safety recommendations had been closed by the time the NTSB report was published in 1996. The NTSB considered that the safety actions implemented by the FAA up to the date the report was published had been effective in reducing accidents of this type.
- 4.3.7. The NTSB report concluded that the R22 was more responsive than other light helicopters to pilots’ cyclic control inputs and that the cause of many of the “loss of main rotor control” accidents likely stemmed from pilots making large and abrupt control movements. The NTSB considered that the low-inertia rotor could diverge from the normal rotation plane and strike the fuselage within 0.5 seconds, so flight instructors would not have sufficient time to react to large or abrupt control movements by trainees unless they were actually holding the cyclic controls¹⁹.
- 4.3.8. The NTSB acknowledged the numerous operational changes implemented by the FAA to ensure that R22 pilots were more knowledgeable about specific R22 hazards and were better trained, and that flights in adverse weather conditions by inexperienced pilots were limited. Accident data since the changes had been implemented in 1995 suggested to the NTSB at the time that the corrective actions should help to prevent such accidents¹⁹.
- 4.3.9. In 1996 the NTSB issued 6 new safety recommendations with the final report. The first recommendation was to make the FAA’s requirement for R22 pilots to undergo special safety awareness training permanent (see the section below on “Special safety awareness training”) and the rest were for further research and the requirement for light helicopter manufacturers

¹⁶ Code of Federal Regulation 14 CFR Part 27.

¹⁷ Part of the helicopter certification tests to CFR Part 27 requires that for one condition, the minimum time delay for corrective action may be one second or the pilot reaction time, whichever is greater. For other test conditions the pilot reaction time is accepted. No value is defined for pilot reaction time.

¹⁸ These facts are described in NTSB, 1996.

¹⁹ Page 27 of the NTSB report, 1996.

to provide standard information about control sensitivity. The NTSB closed the last of these 6 safety recommendations on 17 March 2010.

4.3.10. Improvements were made to the helicopter throttle governor and low rotor RPM warning system, but other issues could not be resolved with simple modifications. The FAA and the NTSB still held concerns about the following residual safety issues:

1. **Low rotor RPM** – The very short time a pilot had in the R22 to respond if the main rotor RPM reduced below the normal acceptable range. This short response time was also the focus of concern with the airworthiness standards noted in separate FAA reviews.
2. **Mast bumping** – When the main rotor plane is tilted in relation to the mast drive shaft beyond its physical limits, **and** the blade spindles contact the mast at each revolution. Within a few revolutions, one or both of the main rotor blades could either completely or partially separate from the rest of the helicopter.
3. **Main rotor divergence and loss of control** – Situations where the R22 main rotor could diverge from its normal **plane** of rotation and strike either the cockpit or the tail boom. The public records from the NTSB and the FAA show that they could not determine the root cause of main rotor divergence and it was too risky to conduct flight experiments. A mathematical model to simulate and study the condition was also abandoned.
4. **Low-gravity condition** – The helicopter is flown in a manner that makes the crew experience a feeling of weightlessness. Under low-gravity situations the R22 can roll unexpectedly to the right, but the pilot’s response on the controls, according to the flight manual, must be with an aft cyclic movement rather than the more intuitive left cyclic to counter the roll. An intuitive response by the pilot could rapidly develop into a mast bump. The flight manual “cautions” pilots that under no circumstances may this manoeuvre be demonstrated or practised in flight²⁰. The manoeuvre is prohibited in the “Limitations” section of the manual.

Special safety awareness training

4.3.11. The FAA decided to address the residual concerns arising from the 3 Special Certification Reviews and the NTSB special investigation by mandating special safety awareness training for pilots and placing operating restrictions when the R22 helicopters were flown by inexperienced pilots. The FAA was also concerned that the R44 helicopter had similar characteristics to the R22. The FAA considered these issues so critical that its response in 1995 was to mandate special safety awareness training for all R22 and R44 pilots before they could conduct their next flights. The requirement was described in Special Federal Aviation Regulation 73 (SFAR 73), which also set a threshold for minimum pilot experience. Pilots with less than the minimum experience would be subject to additional flight restrictions described in SFAR 73 (see Appendix 6: The current version of SFAR 73).

4.3.12. Airworthiness directives (ADs) were issued at the time to set limits for inexperienced R22 and R44 pilots. They were not allowed to fly the helicopters when winds were above a set range or in conditions of moderate or worse turbulence.

4.3.13. Initially SFAR 73 was temporary and the ADs were permanent. The status has changed over the years to SFAR 73 being made permanent on 29 June 2009, and remaining applicable to both the R22 and R44 helicopters. The ADs setting limits for inexperienced pilots remained permanent for the R22, but were rescinded for the R44 because the FAA determined that it was no longer necessary to correct an unsafe condition.

4.3.14. The FAA introduction paragraph in the “Normal Procedures” section of the flight manual stated (FAA, 1996) :

²⁰ This change was made with airworthiness directives AD 95-11-09 for the R22 and AD 95-11-10 for the R44.

Until the FAA completes its research into the conditions and aircraft characteristics that lead to main rotor blade/fuselage contact accidents, and corrective type design changes and operating limitations are identified, Model R22 pilots are strongly urged to become familiar with the following information and comply with these recommended procedures:

[The inserted text went on to describe main rotor stall and mast bumping situations and preventive techniques including a recommended, across-the-board limit of maximum speed to 0.9 Vne (velocity to never exceed).]

New Zealand response

Safety issue – The New Zealand regulatory oversight provided insufficient guidance and mandatory requirements for instructors, pilots and operators of the Robinson type R22 and R44 helicopters to minimise the known risk of exceeding the helicopters’ capabilities.

- 4.3.15. The R22 helicopter type certificate (H10WE) prescribed the conditions and limitations for the helicopter to meet the airworthiness requirements²¹. The FAA-approved flight manual formed part of the type approval certificate. Any subsequent changes the FAA made to the mandatory sections of the flight manual (sections 2 – Limitations, 3 – Emergency Procedures, 4 – Normal Procedures and 5 – Performance) had to be adopted by the aviation authorities in other countries. If they were not adopted, the helicopter would not be considered airworthy in that country.
- 4.3.16. When the R22 was first imported to New Zealand, the CAA accepted the foreign type certificate from the FAA, which is now listed under Advisory Circular AC21-1 Appendix 2. This action made the FAA-approved flight manual valid in New Zealand and obliged the CAA to adopt any future changes to the flight manual in order to retain compliance with the type certificate.
- 4.3.17. The FAA made a number of changes to the conditions for the R22 helicopter through its SFAR 73 and ADs. New Zealand broadly adopted these various changes through the equivalent instruments (see Appendix 5: History of airworthiness directives and SFAR 73 in New Zealand for details of these historical changes). The USA and New Zealand conditions for operating the R22 helicopter were broadly the same until 1998.
- 4.3.18. Post 1998 there were 2 fundamental differences between how the FAA and the CAA regulated the special training and flight limitations for R22 and R44 pilots:
 - the FAA prohibited inexperienced²² pilots from flying (manipulating the controls of) R22 helicopters once wind speed and turbulence reached certain levels, whereas the CAA allowed inexperienced pilots to fly the helicopters in those conditions provided the pilots-in-command (instructors) were experienced
 - in the USA, R22 helicopter instructors had to be especially approved and endorsed by the FAA as being suitable to instruct on the helicopter, whereas in New Zealand there was no special requirement other than that they must have completed the Robinson safety awareness training.

The pilot-flying

- 4.3.19. Given the 0.5-second time it could take for a main rotor divergence to occur, the FAA was concerned that an instructor might not have time to prevent a trainee pilot over-controlling the helicopter in response to turbulence. To address this risk the FAA prohibited inexperienced pilots from manipulating the controls in turbulent and windy conditions. In New Zealand the restrictions were changed to apply only to the pilot-in-command’s experience, irrespective of who was manipulating the controls. (See Appendix 1 for more details.)

²¹ Code of Federal Regulation 14 CFR Part 27 and specified amendment status.

²² The threshold between inexperienced and experienced was determined from accident data and is described in Appendix 4.

- 4.3.20. The New Zealand situation did not therefore address the FAA's concern about reaction time. An instructor can "guard" the cyclic control against over-controlling by the trainee, but this can be challenging because of the cyclic control design. The cyclic control is pivoted on a central pedestal between the pilots. The pilot who is flying pulls their control handle down to a natural and comfortable flying position, which raises the other pilot's handle. Robinson recommends that in turbulence the pilot steady their right arm against their thigh. This has the effect of further raising the cyclic control for the non-flying pilot and, depending on the height of the pilot flying, putting it beyond comfortable reach (Figure 9).
- 4.3.21. The FAA prevents inexperienced R22/R44 pilots acting as pilots-in-command until they meet the minimum flight experience. It also provides for an alternative path if their log books are appropriately endorsed and they undergo annual flight reviews until they meet the minimum level of experience. In New Zealand, R22/R44 pilots with less than the FAA minimum experience are not limited from acting as pilots-in-command.



Figure 9
R22 cyclic control

- 4.3.22. The FAA has set minimum flying times under dual instruction for trainee helicopter pilots wishing to convert to the R22 when they have only fixed-wing flying times, or ratings on other helicopter types. In New Zealand these either do not apply or are set at a lower limit.
- 4.3.23. The FAA requires that all Flight Reviews for pilots wishing to maintain R22 or R44 ratings be carried out in the relevant R22 or R44 helicopters and only with approved R22 or R44 instructors. This is to ensure that their safety awareness knowledge and skills are also current. This requirement does not apply in New Zealand.

The instructors

- 4.3.24. Instructor training in the USA has a separate line of quality control back to the FAA. This has been done to ensure that safety awareness training is delivered in a consistent manner, by instructors who have demonstrated thorough knowledge of the R22 handling characteristics, and demonstrated they have the skills to pass this on through their instructional techniques. In New Zealand any category of helicopter instructor may provide the required safety awareness training for the R22 without any overall national quality control or oversight.
- 4.3.25. The Commission interviewed several experienced R22 instructors from New Zealand. The Commission also convened an industry fact-finding panel discussion with a selected group of the most experienced R22 instructors in New Zealand. The discussion revealed:
- diversity in instructors' understanding of the R22 handling characteristics and limitations
 - diversity in instructors' understanding of the theory behind the Robinson safety awareness training

- that there was no national, standard training syllabus for safety awareness training that instructors could follow.
- 4.3.26. These findings are a serious safety issue. They show that safety awareness training and lessons from fatal accidents caused by pilots exceeding the limitations of the R22 helicopter have not been well conveyed to New Zealand’s most experienced R22 helicopter instructor pilots. The flow-on effects to trainee pilots, of whom some will be New Zealand’s future instructors, means that the situation could get worse unless the CAA intervenes. The Commission has recommended that the CAA address this safety issue.
- 4.3.27. Wanaka Helicopters held operational certificates under 3 parts of the Civil Aviation Rules: Part 119 – Air Operator; Part 135 – Air Operations, Helicopter and Small Aircraft; and Part 141 – Aviation Training Organisations. The CAA carried out regular audits for compliance with each of these parts.
- 4.3.28. The operator had also developed its training systems to meet the New Zealand Qualifications Authority’s qualifications framework and was separately audited for compliance against its requirements.
- 4.3.29. The operator had systems in place to train new pilots and review trainees’ progress amongst the instructor team. The CAA audits for the previous 2 years had not revealed any concerns and the New Zealand Qualifications Authority’s audit had commented favourably on the training systems and facilities in place. No issues had been found with the operator’s management or operating systems.
- 4.3.30. The question then arises, why did the instructor on this occasion allow the helicopter to enter an area of predictably strong turbulence at high altitude and with the helicopter close to its maximum permissible weight?
- 4.3.31. The instructor may have been approaching Matukituki Saddle to test the weather conditions with the intention of “escaping” if they proved untenable. He may have simply been caught unawares by the ferocity of the wind and turbulence as he approached Waipara Saddle. An instructor who fully understood the limitations of the R22 helicopter and who knew of the conditions ahead would have been less likely to attempt this manoeuvre.

Findings:

4. The instructor on board the helicopter was possibly unaware of how critical and unsafe it was to fly the R22 helicopter at high altitude, at near maximum weight, and in conditions of moderate to extreme turbulence.
5. The New Zealand regulatory oversight provided insufficient guidance and mandatory requirements for instructors, pilots and operators of the Robinson type R22 and R44 helicopters to minimise the known risk of exceeding the helicopters’ limitations.

Flight manual (clarity of safety-critical information)

Safety issue – The format of the Robinson R22 helicopter flight manual and the terminology it uses do not draw appropriate attention to safety-critical instructions and conditions that could result in serious injury or death.

- 4.3.32. The flight manual contains the manufacturer’s description of the helicopter’s performance, limitations, emergency procedures and systems. It forms part of the type certification requirements and must be carried with the helicopter at all times. This document guides pilots on how to handle the helicopter safely and keep within the flight limitations defined by the manufacturer.
- 4.3.33. The “Limitations” section of the R22 flight manual is approved by the FAA to ensure a minimum standard. The other sections, such as the “Safety Notices” section, are provided by

the manufacturer for the benefit of pilots, owners and operators. Some inconsistencies have evolved with the R22 flight manual over time as it has been amended by the manufacturer, by the FAA and, in New Zealand's case, by the CAA.

- 4.3.34. Robinson Helicopter Company has developed a number of safety notices to assist pilots and warn them about identified hazards and safety-critical situations to be avoided. Some of these safety-critical situations have been carried forward to the mandatory "Limitations" section of the manual – the section to which all pilots must adhere. However, others have not.
- 4.3.35. Robinson Helicopter Company has produced safety notices (see Appendix 7: Relevant Robinson Helicopter Company R22 safety) that explain the hazards of, and how to manage:
- low-gravity manoeuvres (SN-11)
 - low-RPM main rotor stall (SN-24)
 - high winds and turbulence (SN-32).
- 4.3.36. The FAA's AD 95-26-04, made in 1995, limited the helicopter to 70% of the maximum allowable airspeed (0.7 of Vne or about 71 knots) when turbulence was encountered²³. The R22 flight manual has been revised several times since 1995, but by 2011 the "Limitations" section of the flight manual still did not mention any airspeed limit for the helicopter in turbulent and windy conditions. Given the R22's susceptibility to in-flight break-ups from main rotor divergence in turbulent conditions, this matter should have been highlighted in the mandatory "Limitations" section of the manual. Given that the pilots of small aircraft rarely check the content of a flight manual when flying, it would be a useful prompt for pilots to have this limitation marked on the airspeed indicator or prominently placarded in the cockpit.
- 4.3.37. Another safety issue arises over how Warnings, Cautions and Notes are referred to in the Robinson flight manual. The FAA provides an advisory circular for manufacturers that describes an acceptable means of compliance for the content and structure of the flight manual in order to meet certification requirements²⁴.
- 4.3.38. The advisory circular states that, "Warnings should be used with respect to safety matters that are immediately imminent" and that "Cautions should be used for safety matters that are not imminent". Notes refer to important information that does not fit within either of the other 2 descriptions. These definitions are generally interpreted by aircraft manufacturers to mean that non-compliance with a Warning could cause death or serious injury and non-compliance with a Caution could cause damage to the aircraft.
- 4.3.39. The Robinson flight manual does not use the term "Warning". The term "Caution" is used to describe actions that are likely to prove fatal or cause damage to the helicopter. Although these terms did not have the more commonly accepted industry interpretations, they were not specifically defined in the manual until 2012. For example the "Flight and manoeuvre limitations"²⁵ section of the manual has a "Caution" at the top about low "G" conditions that it states, "... can result in catastrophic loss of lateral control". This would normally be described as a "Warning" under the FAA guidelines because if the caution is not followed, a loss of lateral control would be immediately imminent and highly likely result in a fatal accident.
- 4.3.40. According to the CAA's aeronautical information publication, about 60% of New Zealand is designated as mountainous terrain, including most of the South Island. Wind blowing across mountainous areas results in turbulence as it is channelled through or over the terrain, causing sudden changes in wind speed and direction. R22 instructors and trainee pilots should be absolutely clear in their understanding of how hazardous it is to operate R22 helicopters in moderate to extreme turbulence. It is possible that the significance of this

²³ The operator advised that this lower speed was related to the desired lower power setting, which would have reduced the risk of a right roll and potential mast bumping situation.

²⁴ FAA Advisory Circular AC 27-1.

²⁵ Pages 2-6 in Appendix 4.

information has been lost to the New Zealand Robinson helicopter pilot fraternity, through the dilution of the Robinson safety awareness training in New Zealand and the benign way in which critical safety information has been presented in the flight manual.

Finding:

6. The format of the Robinson R22 helicopter flight manual and the terminology it uses do not draw appropriate attention to safety-critical instructions and situations that could result in serious injury or death.

R22 safety performance (New Zealand)

Safety issue – The rate of R22 in-flight break-up accidents in New Zealand has not been significantly reduced by the New Zealand version of the FAA hazard mitigation measures intended to prevent such accidents.

- 4.3.41. The New Zealand R22 accident data was analysed and compared with the USA data to provide an indication of how the different approaches taken by the FAA and the CAA had influenced the accident rates in the respective countries. Four graphs are provided in Appendix 8 with a summary below.
- 4.3.42. Accident data was obtained from the FAA and the CAA. The lists of fatal R22 accidents were reviewed from the published accident briefs and categorised into 3 groups to represent accidents that were likely to be examples of the types that the special safety awareness training²⁶ was intended to prevent. Each of the 3 categories is shown in a different colour in the graphs in Appendix 8. The 3 categories are that the accident:
- was caused by an in-flight break-up of the helicopter
 - was caused when the main rotor speed decreased below acceptable limits (low main rotor RPM)
 - was caused by some other reason, such as pilot actions, collision with trees, heavy landing or mechanical failure, and is therefore not relevant to this safety issue.
- 4.3.43. The number of fatal accidents in New Zealand and the USA related to in-flight break-up and low rotor RPM was counted from 1985 to 1998, and compared with the number from 1999 to 2012. These date ranges spanned 14 years and coincided with both countries having the same conditions up to 1998 in relation to the SFAR 73 training requirements, but a diverging situation post 1998. These numbers were divided by the average fleet size during the same periods to obtain an accident rate per operational helicopter, then normalised to represent accidents per 1000 registered aircraft.
- 4.3.44. The data does not show any low rotor RPM-type accidents in New Zealand because the information available did not list these as having fatal results.
- 4.3.45. The USA registration data is approximate because it is based on the number of R22s registered in September 2013 using the years in which they were manufactured. Seventy-seven records from the FAA data did not contain values for the “year of manufacture”. These records have been excluded but one was subsequently reused because the helicopter’s serial number indicated it had been built in 2009 and otherwise there was no record for that year.
- 4.3.46. The available data did not include the average hours flown per aircraft per year, so the Commission could not determine if there were significant differences in R22 operations between New Zealand and the USA. Consequently the exposures to risk from the selected accident causes may differ.

²⁶ Described in SFAR 73.

- 4.3.47. For the purposes of comparison, this analysis assumes that flight hours per aircraft per year in the 2 countries were broadly similar, and that aircraft use had stayed relatively constant during the period. On this basis, the rate of fatal R22 accidents appeared to have dropped during the period examined by a considerably greater degree in the USA than it had in New Zealand.
- 4.3.48. In the USA, the rate of fatal accidents per 1000 registered R22 aircraft dropped from 3.4 per year from 1985 to 1998 to 1.4 per year from 1999 to 2012 (a 59% reduction). The corresponding figures in New Zealand were a drop from 4.5 fatal accidents per year from 1985 to 1998 to 3.7 per year from 1999 to 2012 (a 17% reduction).

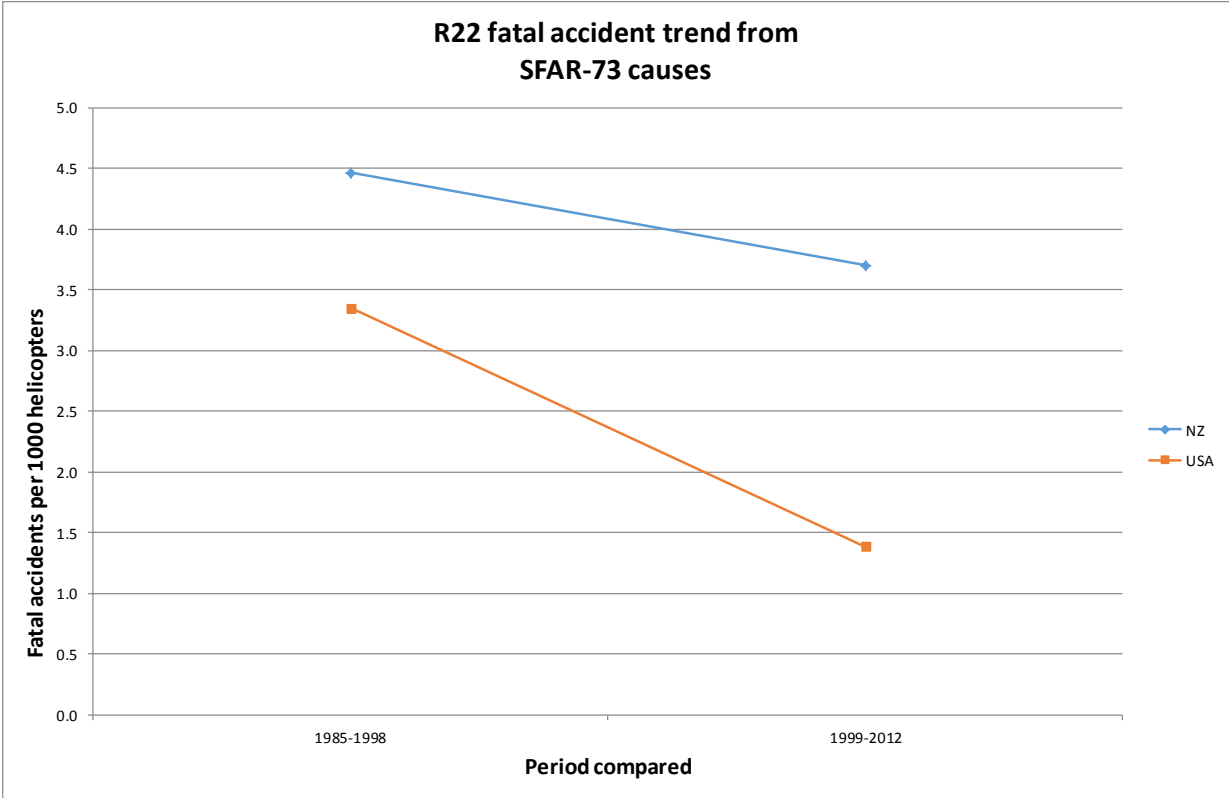

- 4.3.49. These figures indicated low annual accident rates and did not provide a robust basis for direct statistical analysis between the 2 separate aeronautical jurisdictions.
- 4.3.50. The New Zealand accident rate has not trended downwards since the introduction of safety awareness training in 1995. There appears to have been an initial reduction in R22 accidents post 1995, but since the CAA introduced reduced safety awareness requirements in 1998, New Zealand has had an average of one R22 in-flight break-up accident every 18 months since 2002.
- 4.3.51. These figures, together with the findings from the group discussion with senior R22 instructors, highlights again the need for the CAA to intervene and raise awareness amongst pilots and helicopter training organisations of the characteristics and limitations of the R22 helicopter.

Finding

7. The rate of R22 in-flight break-up accidents in New Zealand has not been significantly reduced by the New Zealand version of the FAA hazard mitigation measures intended to prevent such accidents.

4.4. Locating aircraft

Emergency locator transmitters (ELT)

- 4.4.1. The helicopter was fitted with a 406-megahertz ELT in accordance with New Zealand aviation rules. This device is designed to activate automatically when pre-set gravitational forces are exceeded. It can also be manually activated by the pilot using a remote switch.
- 4.4.2. Once activated, the ELT is designed to transmit continually 2 separate radio signals sequentially until it exhausts the battery capacity or is turned off. The first is a low-power transmission intended as a homing signal. The second is a digital coded message transmitted to a geosynchronous satellite network to alert the relevant rescue co-ordination centre.
- 4.4.3. When the helicopter crashed, the ELT activated but was so severely damaged that it was unable to transmit a useable location signal. In this case, however, the flight tracking device installed on the helicopter had been transmitting position reports to the operator's base, so when the helicopter was reported overdue search aircraft were directed immediately to the general area where the helicopter had crashed.
- 4.4.4. The failure of ELTs to function correctly after crashes is a common concern worldwide. Several investigations have been conducted into the performance of ELTs²⁷. The International Civil Aviation Organization and International Maritime Organization are actively seeking improvements in the crash survivability of the transmitters and for them to have mandatory global positioning system (GPS) capabilities.
- 4.4.5. All of the investigations concluded that insufficient accident data was being collected on ELT performance to make any meaningful recommendations.
- 4.4.6. The CAA carried out research into the use of ELTs and flight tracking devices in New Zealand and compared the effectiveness and installation requirements of both systems (CAA-1, 2010). The report identified common issues with ELTs, including crash survivability and aerial disconnection failures. It also reviewed data available from the CAA database about ELTs and acknowledged that CAA records on ELT failures were unreliable.
- 4.4.7. In the absence of any other comparable system for locating aircraft following occurrences, the CAA has continued, and should continue, to support the International Civil Aviation Organization/International Maritime Organization endeavours to improve the crash survivability of ELTs. At the time of drafting this report, the CAA was continuing to address crash tolerance with ELT manufacturers and was working with Rescue Coordination Centre New Zealand to test an internally mounted aerial. It had also issued an advisory circular (AC 43-11) with details to improve the survivability of ELT aerals and conducted ongoing discussions with licensed engineers and operators. No action had been taken towards improving CAA data collection on ELT survivability.

Flight tracking devices

- 4.4.8. Separate flight tracking devices can be installed by operators if desired. Flight tracking devices are not a direct substitute for ELTs because they do not alert anyone that a crash has occurred. They do, however, provide a useful record of where an aircraft has been and its general location after an occurrence, as it did in this case.
- 4.4.9. The value of flight tracking devices and the failure of ELTs became a discussion point after a Eurocopter EC120B ZK-HTF fatal accident near Raglan in 2005 (CAA-1, 2010). The coroner recommended that, "CAA immediately engage with representatives of the flight tracking device industry for the purposes of consultation to develop technical standards and minimum

²⁷ The Defence and Research Development of Canada (Defence R&D Canada, 2009), Australian Transport Safety Bureau (ATSB, 2013), Cospas-Sarsat, submission in 2010 to the International Civil Aviation Organization/International Maritime Organization joint working group (ICAO/IMO JWG-SAR/17-IP.5 18 August 2010, Agenda item 7).

performance criteria for missing aircraft detection and location” (Matenga, 2010). At the time of drafting this report the CAA was continuing to engage with New Zealand flight tracking device manufacturers.

- 4.4.10. Flight tracking devices are still being installed under the classification of “portable electronic devices” and as “non-aeronautical avionics devices/systems”. The CAA has accepted these installations due to the benefits that flight tracking devices provide.
- 4.4.11. Operators should consider installing flight tracking devices on their aircraft because they improve the chances of aircraft being found as soon as possible following accidents, particularly in the event of ELT failures.

Findings:

- 8. A more crashworthy ELT would not have altered the outcome of this accident, because the crash was not survivable and the flight tracking device was able to guide search aircraft to the general location of the crash site. However, under different circumstances a more crashworthy ELT has the potential to save lives.
- 9. The flight tracking devices in aircraft are a good enhancement for locating crashed and disabled aircraft, which means they have the potential to save lives.
- 10. Improving the crashworthiness of ELTs fitted to aircraft will improve flight safety by speeding up the search and first response to aircraft accidents. The CAA should continue to support the international effort to improve standards for such devices.

5. Findings

- 5.1. The helicopter was operating in conditions of reduced power margin where it was near to the maximum allowable weight, and flying at relatively high altitude in strong wind and moderate to extreme turbulence, at the time it broke up in flight.
- 5.2. The cause of the in-flight break-up was main rotor blade divergence caused by a possible combination of the following factors:
 - the helicopter entering low-gravity flight (more likely as a consequence of turbulence)
 - turbulence
 - excessive movements of the cyclic control
 - low main rotor blade RPM.
- 5.3. There was no evidence found that mechanical failure initiated the in-flight break-up, but the major damage to the engine and other components meant that the possibility of this could not be excluded.
- 5.4. The instructor on board the helicopter was possibly unaware of how critical and unsafe it was to fly the R22 helicopter at high altitude, at near maximum weight, and in conditions of moderate to extreme turbulence.
- 5.5. The New Zealand regulatory oversight provided insufficient guidance and mandatory requirements for instructors, pilots and operators of the Robinson type R22 and R44 helicopters to minimise the known risk of exceeding the helicopters' limitations.
- 5.6. The format of the Robinson R22 helicopter flight manual and the terminology it uses do not draw appropriate attention to safety-critical instructions and situations that could result in serious injury or death.
- 5.7. The rate of R22 in-flight break-up accidents in New Zealand has not been significantly reduced by the New Zealand version of the FAA hazard mitigation measures intended to prevent such accidents.
- 5.8. A more crashworthy ELT would not have altered the outcome of this accident, because the crash was not survivable and the flight tracking device was able to guide search aircraft to the general location of the crash site. However, under different circumstances a more crashworthy ELT has the potential to save lives.
- 5.9. The flight tracking devices in aircraft are a good enhancement for locating crashed and disabled aircraft, which means they have the potential to save lives.
- 5.10. Improving the crashworthiness of ELTs fitted to aircraft will improve flight safety by speeding up the search and first response to aircraft accidents. The CAA should continue to support the international effort to improve standards for such devices.

6. Safety actions

General

- 6.1. The Commission classifies safety actions by 2 types:
- (a) safety actions taken by the regulator or an operator to address safety issues identified by the Commission during an inquiry that would otherwise result in the Commission issuing a recommendation
 - (b) safety actions taken by the regulator or an operator to address other safety issues that would not normally result in the Commission issuing a recommendation.

Safety actions addressing safety issues identified during an inquiry

- 6.2. No safety actions were identified.

7. Recommendations

General

- 7.1. The Commission may issue, or give notice of, recommendations to any person or organisation that it considers the most appropriate to address the identified safety issues, depending on whether these safety issues are applicable to a single operator only or to the wider transport sector. In this case, recommendations have been issued to the CAA.
- 7.2. In the interests of transport safety it is important that these recommendations are implemented without delay to help prevent similar accidents or incidents occurring in the future.

Recommendations

- 7.3. Post 1998 there were 2 fundamental differences between how the FAA and the CAA regulated the special safety awareness training and flight limitations for R22 and R44 pilots:
 - the FAA prohibited inexperienced pilots from flying R22 helicopters once wind speed and turbulence reached certain levels, whereas the CAA allowed inexperienced pilots to fly the helicopters in those conditions provided the pilots-in-command (instructors) were experienced
 - in the USA, R22 helicopter instructors had to be especially approved and endorsed by the FAA as being suitable to instruct on the helicopter, whereas in New Zealand there was no special requirement other than that they must have completed the Robinson safety awareness training.

A discussion with senior New Zealand instructors on Robinson helicopters revealed that in New Zealand there was:

- diversity in instructors' understanding of the R22 handling characteristics and limitations
- diversity in instructors' understanding of the theory behind the Robinson safety awareness training
- no national, standard training syllabus for the safety awareness training that instructors could follow.

New Zealand's regulatory system has not properly publicised to the aviation industry the safety-critical limitations of the R22 helicopter, and has not adequately controlled the standard of instructor and pilot training in the way it has been controlled in the USA, where the helicopter is manufactured.

These findings show that safety awareness training and lessons from fatal accidents caused by pilots exceeding the limitations of the R22 helicopter have not been well conveyed to New Zealand's most experienced R22 helicopter instructor pilots. The flow-on effects to trainee pilots, of whom some will be New Zealand's future instructors, means that the situation could get worse unless the CAA intervenes.

On 26 February 2014 the Commission recommended that the Director of Civil Aviation:

- a. conduct a review of Robinson safety awareness training in New Zealand and facilitate the development and adoption of best practice across the sector, including a level of consistency in the way instructors deliver the safety awareness training (003/14)
- b. review FAA SFAR 73 in the context of the New Zealand aviation system and adopt relevant improvements that would likely enhance the operational safety of Robinson aircraft in New Zealand (004/14).

On 5 March 2014 the CAA replied, in part:

003/14 – the recommendations will be implemented in the form of a review by the Personal licencing and Flight Training Unit, along with the Helicopter and Agricultural Operations Unit of the CAA. The review is envisaged to take approximately 12 to 15 months to complete.

004/14 – the recommendation will be implemented in the form of a review by the Helicopter and Agricultural Operations Unit. The review is envisaged to take approximately 12 to 15 months to complete.

- 7.4. A more crashworthy ELT would not have altered the outcome of this accident, because the crash was not survivable and the flight tracking device was able to guide search aircraft to the general location of the crash site. However, under different circumstances, a more crashworthy ELT has the potential to save lives.

Improving the crashworthiness of ELTs fitted to aircraft will improve flight safety by speeding up the search and first response to aircraft accidents. The CAA should continue to support the international effort to improve standards for such devices.

The flight tracking devices in aircraft are a good enhancement for locating crashed and disabled aircraft, which means they have the potential to save lives. The installation of these devices to complement ELTs should be encouraged.

On 26 February 2014 the Commission recommended that the Director of Civil Aviation:

- a. encourage the use of flight tracking devices, especially for use in aircraft operating in remote areas around New Zealand (005/14)
- b. continue to support the international work underway to improve the crash survivability of ELTs and to include GPS information in the data transmitted by such devices (006/14).

On 5th March 2014, the CAA replied, in part:

005/14 – In our draft recommendation response 31 January 2014, the Director commented that the CAA provide for the fitment of Flight Tracking Devices (FTDs) by operators and this can be achieved in accordance with the relevant provisions of AC 43-14. The CAA will continue to encourage operators to fit FTDs in this manner. The CAA considers the action sufficient to satisfy the closure of the Commission's recommendation.

006/14 – in the same response letter, the Director commented that the CAA already supports in principle the ICAO and manufacturers' efforts to improve the crash survivability of ELTs and accuracy of position reporting. The work is ongoing and in this context the CAA requests that the recommendation be closed.

8. Key lessons

- 8.1. Any aviation regulatory system must ensure that recommended and permissible maximum operating parameters for an aircraft type are clearly and consistently articulated to pilots, regardless of the country in which the aircraft is operated.
- 8.2. Pilots must be fully aware of the operating limitations for aircraft they fly, and must always stay within those limitations.

9. Works cited

- ATSB. (2013). *A review of the effectiveness of emergency locator transmitters in aviation accidents (AR-2012-128)*. Canberra: Australia Transport Safety Bureau.
- CAA. (2006). *Mountain Flying: Good aviation practice*. Wellington: Civil Aviation Authority of New Zealand.
- CAA-1. (2010). *Missing Aircraft Detection & Location, Technology & system status review 2010*. Wellington: Civil Aviation Authority of New Zealand.
- CAA-2. (2010). *VFR Met: Good aviation practice*. Wellington: Civil Aviation Authority of New Zealand.
- Defence R&D Canada. (2009). *Emergency Locator Transmitter (ELT) Performance in Canada from 2003 to 2008: Statistics and human factors issues. TR2009-101*. Toronto: Defence R&D Canada.
- FAA. (1996, January 26). *Federal Aviation Administration\Airworthiness Directives*. Retrieved March 8, 2013, from Current Airworthiness Directives by product Type: http://rgl.faa.gov/Regulatory_and_Guidance_Library/rgAD.nsf/0/91BE0874983FB92686256A4D0061449D?OpenDocument
- FAA FSB. (1995). *FAA R22 Flight Standardization Board Report, Aircraft Evaluation Group*,. Fort Worth, Texas: Federal Aviation Administration.
- Matenga, G. (2010). *Findings of Coroner under Coroners Act 1988, Michael Anthony Erceg*. Hamilton: Coronial Services Unit, New Zealand.
- NTSB. (1996). *Special Investigation Report NTSB/SIR-96/03*. Washington, D.C. 20594: National Transportation Safety Board.

Appendix 1: Comparison of USA and New Zealand Robinson helicopter requirements

Situation	USA requirements	New Zealand requirements
<p>Before manipulating the controls of an R22/R44</p>	<p>[SFAR 73] Prior to <u>manipulating the controls</u> of an R22 or R44, a person must have undergone the special safety awareness training specified in SFAR 73-2, which includes theory and practical. This training must be refreshed at each 24-month flight review. The general subject areas are:</p> <ol style="list-style-type: none"> 1. Energy management 2. Mast bumping 3. Low rotor RPM (blade stall) 4. Low G hazards 5. Rotor RPM decay. 	<p>[NZ CAA 2140] Prior to <u>acting as pilot-in-command</u> of an R22, all persons shall have completed safety awareness training within the previous 24 months and have that endorsed in their log books. Safety awareness training must cover theory and flight practice in the following topics:</p> <ol style="list-style-type: none"> a) Rotor RPM control and the importance of avoiding rotor RPM decay b) Low G hazards and factors leading to mast bumping c) Enhanced training in auto rotational procedures to maintain safe rotor RPM throughout the manoeuvre d) Other aspects outlined in the Robinson Helicopter Company Safety Course.
<p>Minimum dual experience for trainees and licensed pilots of aircraft other than helicopters</p>	<p>[SFAR 73] A person who does not hold a rotorcraft category and helicopter class rating must have had at least 20 hours of dual instruction in a Robinson R22 helicopter prior to operating it in solo flight. In addition, the person must obtain an endorsement from an authorised instructor for an R22 in their log book that the person is proficient to fly solo in an R22. This endorsement is valid for a period of 90 days.</p>	<p>The requirements above for safety awareness training before acting as pilot-in-command.</p> <p>Persons who do not hold helicopter pilot licences must have received 10 hours' dual instruction in an R22 helicopter. This training must be dual general handling instruction and shall exclude cross-country time.</p>

Situation	USA requirements	New Zealand requirements
Limitations for pilots with less than the specified “minimum experience”	<p>[AD 95-26-04] Until a pilot has a minimum helicopter flight experience of at least 200 hours in helicopters, including at least 50 in the R22, they are prohibited from <u>manipulating the controls</u> in conditions where:</p> <ul style="list-style-type: none"> a) Surface wind exceeds 25 knots including gusts, or b) Surface wind gust spread exceeds 15 knots, and c) If moderate turbulence or worse is inadvertently encountered, continued flight is prohibited. 	<p>[NZ CAA 2140] Unless <u>the pilot acting as pilot-in-command</u> has logged at least 200 hours in helicopters, including at least 50 in the R22, they are:</p> <ul style="list-style-type: none"> a) Prohibited from flight in winds forecast or experienced in excess of 25 knots, and b) Flight when wind gust spread is forecast or experienced in excess of 15 knots, and c) Continued flight in moderate, severe or extreme turbulence is prohibited.
Alternative to the minimum experience requirement to act as pilot-in-command (for example, a trainee’s solo flight)	<p>[SFAR 73] A person may not act as pilot-in-command of an R22 unless that person exceeds the minimum experience limits.</p> <p>Alternatively a pilot with at least 10 hours’ dual with an authorised instructor in an R22 and with an endorsement in their log book from that instructor that the pilot is proficient to act as pilot-in-command, may act as pilot-in-command.</p> <p>Such an endorsement is only valid for 90 days and the pilot is required to complete annual flight reviews in the R22 until having exceeded the minimum experience threshold.</p>	<p>There is no alternative, the conditions apply as above.</p> <p>[NZ CAA 2140] Prior to <u>acting as pilots-in-command</u> of R22s, all persons shall have completed safety awareness training within the previous 24 months and have that endorsed in their log books.</p> <p>Persons who do not hold helicopter pilot licences must have received 10 hours’ dual instruction in an R22 helicopter. This training must be dual general handling instruction and shall exclude cross-country time.</p>
Definition of moderate turbulence	<p>[AD 95-26-04] Moderate turbulence was described as turbulence that caused changes in altitude or attitude, or variations in airspeed, or when the occupants felt definite strains against the seat belts.</p>	<p>[NZ CAA 2140] Same.</p>
Airspeed limit in turbulence	<p>[AD 95-26-04] If turbulence is encountered, the R22 must be flown above 60 knots but not more than 0.7 Vne.</p>	<p>[NZ CAA 2140] Virtually the same.</p>

Situation	USA requirements	New Zealand requirements
<p>Recommended flight limitations inserted in the "Normal Procedures" section</p>	<p>[AD 95-26-04] Additionally R22 pilots were "strongly urged" to:</p> <ul style="list-style-type: none"> a) Maintain cruise speeds between 60 knots and 0.9 Vne [approximately 92 knots at sea level] but no slower than 57 knots b) Use maximum power-on RPM at all times during powered flight c) Avoid sideslip and maintain in-trim flight at all times d) Avoid large, rapid cyclic movements in forward flight e) Avoid abrupt control inputs in turbulence. 	<p>The same page is inserted in the same place.</p>

Situation	USA requirements	New Zealand requirements
<p>Minimum dual experience for helicopter licensed pilots seeking ratings in the R22 or R44</p>	<p>Before manipulating the controls the pilot must have completed the Robinson safety awareness training set out in SFAR 73.</p> <p>No person may act as pilot-in-command of an R22/R44 until they have at least 10 hours' dual in the appropriate R22/R44 helicopter and this is endorsed in their log book by an authorised instructor who has given instruction in the specified manoeuvres and procedures and found the applicant to be proficient to fly solo.</p> <p>Until a pilot has a minimum helicopter flight experience of at least 200 hours in helicopters including at least 50 in the R22, they are prohibited from <u>manipulating the controls</u> in conditions where:</p> <ul style="list-style-type: none"> a) Surface wind exceeds 25 knots including gusts, or b) Surface wind gust spread exceeds 15 knots, and c) If moderate turbulence or worse is inadvertently encountered, continued flight is prohibited. 	<p>Prior to <u>acting as pilots-in-command</u> of R22s, all persons shall have completed safety awareness training within the previous 24 months and have that endorsed in their log books.</p> <p>Pilots undertaking type ratings on R22 helicopters shall not carry passengers until at least 3 hours have been logged under training, unless the pilots are holders of another Robinson helicopter type rating.</p> <p>Unless <u>the pilot acting as pilot-in-command</u> has logged at least 200 hours in helicopters, including at least 50 in the R22, they are:</p> <ul style="list-style-type: none"> a) Prohibited from flight in winds forecast or experienced in excess of 25 knots, and b) Flight when wind gust spread is forecast or experienced in excess of 15 knots, and c) Continued flight in moderate, severe or extreme turbulence is prohibited.

Situation	USA requirements	New Zealand requirements
Who can provide instruction or conduct Flight Reviews in a Robinson R22?	<p>Certified flight instructors who have:</p> <ul style="list-style-type: none"> • completed Robinson safety awareness training • the minimum flight experience (200/50 hours) • completed flight training in the specified procedures • been authorised by endorsement from FAA aviation safety inspectors or authorised designated examiners that the instructors have completed the appropriate training, meet the experience requirements and have satisfactorily demonstrated an ability to provide the required instruction. 	[NZ CAA 2140] Any A or B category helicopter instructor, or a C category instructor who has completed the manufacturer's approved flight safety course, may give instruction on the R22 if they have more than the minimum experience (200 hours and 50 hours). The subject areas are listed in the flight manual.
Flight Review	<p>Flight reviews are only valid for the R22/R44 if carried out in the appropriate helicopter.</p> <p>Flight reviews must include a review of the Robinson safety awareness subject areas and the flight training defined in SFAR 73.</p>	No specific requirements for Robinson helicopters.

Appendix 2: Weather forecasts

These forecasts were available to the pilots for the day of the accident flight.

Area forecasts

ARFOR CY VALID 1700 TO 0200 UTC
3000 VRB05
5000 13005 PS04
7000 14010 PS02
10000 15010 MS02
FZL 9000FT
VIS 40KM
CLD FEW AREAS BKN SC 4000 TOPS 6000.
WX NIL SIG.
TURB NIL SIG.
ICE NIL.

ARFOR FD VALID 1700 TO 0200 UTC
1000 11005
3000 12010
5000 12015 PS06
7000 13015 PS03
10000 16010 MS01
FZL 9500FT
VIS 40KM
CLD AREAS BKN SC 3000 TOPS 6000
WX NIL SIG.
TURB NIL IG.
ICE NIL.

ARFOR WW VALID 1700 TO 0200 UTC
1000 15005
3000 13010
5000 12015 PS07
7000 12020 PS03
10000 13020 MS01
FZL 9500FT
VIS 40KM
CLD A FEW AREAS BKN SC 3500 TOPS 6000.
WX NIL SIG.
TURB NIL SIG.
ICE NIL.

Aerodrome forecasts

TAF NZQN 261458Z 2614/2707
06005KT 30KM FEW030
2000FT WIND 04010KT =

TAF NZWS 261610Z 2614/2707
14012G25KT 30KM FEW045
2000FT WIND 14025KT =

TAF NZHK 261610Z 2614/2707
13008KT 30KM FEW040

2000FT WIND 14015KT =
TAF NZMF 261610Z 2614/2707
12008G20KT 30KM FEW050
2000FT WIND 16015KT =

TAF NZWF 261614Z 2614/2707
13008KT 30KM SCT045
2000FT WIND 08010KT =

Aerodrome routine meteorological reports

METAR NZWS 262000Z AUTO 15014KT 30KMNDV OVC080 14/02 Q1017
METAR NZHK 262000Z AUTO 11009KT 20KMNDV NCD 09/M05 Q1020
METAR NZWF 262000Z AUTO 14007KT 110V170 30KMNDV NCD 01/M01 Q1028
METAR NZQN 262000Z AUTO 05004KT 010V220 50KMNDV NCD M02/M03 Q1029
METAR NZMO 262000Z AUTO 04001KT 2600NDV BR FEW002 M04/M05 Q1029

METAR NZWS 262030Z AUTO 15016KT 30KMNDV FEW080 BKN100 14/01 Q1017
METAR NZHK 262030Z AUTO 09009KT 20KMNDV NCD 11/M05 Q1020
METAR NZWF 262030Z AUTO 14006KT 30KMNDV NCD 02/00 Q1029
METAR NZQN 262030Z AUTO 03004KT 49KMNDV NCD M01/M02 Q1029
METAR NZMO 262030Z AUTO 05001KT 23KMNDV FEW002 M02/M03 Q1029

METAR NZWS 262100Z AUTO 15021G31KT 30KMNDV BKN090 14/02 Q1017
METAR NZHK 262100Z AUTO 14005KT 110V170 20KMNDV NCD 13/M04 Q1020
METAR NZWF 262100Z AUTO 13010KT 30KMNDV NCD 03/00 Q1029
METAR NZQN 262100Z AUTO 05003KT 48KMNDV NCD 01/M01 Q1029
METAR NZMO 262100Z AUTO 10001KT 30KMNDV NCD 00/M02 Q1030

MetService analysis charts

This chart was available but not downloaded by Wanaka Helicopters.



METSERVICE

MSL ANALYSIS VALID 0000 27-APR-2011 UTC
ISSUED 0152 27-APR-2011 UTC

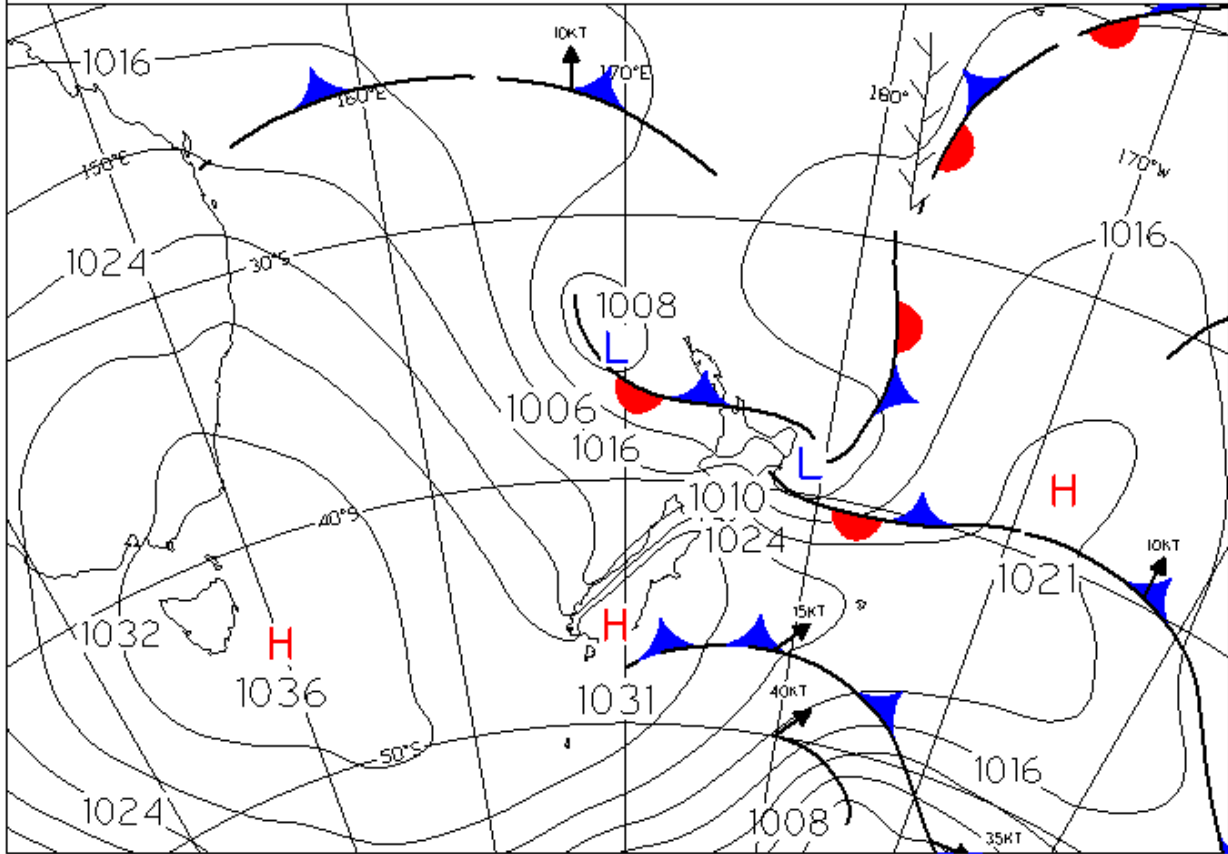

LOOP

©MetService of New Zealand Limited 2011

Appendix 3: R22 in-flight break-up accident reports

Year	Accident brief (New Zealand)	New Zealand reference
1996	ZK-HDD, Matawai, 30 miles north west of Gisborne. Tail boom chop due to sudden pilot manoeuvre. Returning from hunting operation after civil twilight time.	CAA 96/3239
2002	ZK-HEZ, Fox Glacier – Operating at near maximum gross weight at 5500ft pressure altitude. Tail boom chop due to main rotor stall.	CAA 02/71
2003	ZK-HUL, Masterton – Low main rotor RPM resulting in main rotor stall. Blade struck cabin. Refers to Robinson Helicopter Company safety notices SN-24 and others.	CAA 03/127
2004	ZK-HXT, Near Lake Rotokawa, Taupo – Uncorrected low G situation that led to main rotor stall.	CAA 04/39
2008	ZK-HXR, Lake Wanaka – Mast bump then main rotor impact with cabin.	CAA 08/4608 and TAIC 08-007
2010	ZK-HIP, Bluff Harbour – Low main rotor RPM leading to main rotor blade stall and impact with cabin. Refers SN-24.	CAA 10/3987
2011	ZK-HMU, Mount Aspiring National Park – Operating near maximum gross weight at 5500 feet pressure altitude in severe turbulence. Mast bump and tail chop	TAIC 11-003
2012	ZK-HCG, Crown Range, Wanaka – (preliminary) The helicopter broke up in flight and fell to the ground.	CAA No details

Year	Accident brief (outside New Zealand)	Reference
2000	G-BNUZ, Biggin, North Yorkshire, United Kingdom (UK). Engine failure led to low rotor RPM and tail boom chop.	AAIB EW/C2000/12/3
2002	C-FCBG, Manning, Alberta, Canada. In-flight break up and tail boom chop.	TSB A02W0064
2003	G-VFSI, Hampton Magna, Warwickshire, UK. Helicopter flying normally at 1500 feet when it broke up in flight and fell to the ground. Evidence of mast bumping and tail boom chop.	AAIB EW/C2002/07/01
2003	VH-OHA, Bankstown, New South Wales, Australia. Helicopter flying normally with instructor and student when witnesses heard loud bang and one observed the main rotor separate from the helicopter and the fuselage	ATSB 200302820

Year	Accident brief (outside New Zealand)	Reference
	fall inverted to the ground.	
2004	G-TGRR, Bishopton, Warwickshire, UK. Possible carburettor icing led to low rotor RPM and tail boom chop.	AAIB EW/C2004/11 /02
2004	N8118L, Rochester, Minnesota, USA. Witness saw R22 bobble side to side at 100 feet travelling at about 30 knots then within 2-3 seconds it rolled and fell out of the sky. The tail boom was chopped at Bays 3 and 5. SN-24 referred to in report. (Low main rotor RPM.)	NTSB CH104FA177
2006	N7512G, Scottsdale, Arizona, USA. In flight break up and fall to the ground. Pilot error refer to SN-24. (Low main rotor RPM.)	NTSB ANC06FA020
2007	D-HZAK, Buhl, Germany. Tail boom chop (Germany). No other details.	NTSB DEN07WA159
2009	N4160A, Fillmore, California, USA. Main rotor stall and tail boom chop. Appears to have been multiple causes of carb icing and vibrations from tail rotor drive shaft out of balance.	NTSB WPR09FA104
2009	N956SH, Forest Grove, Oregon, USA. Main rotor stall and tail boom chop. Pilot error refer to SN-24.	NTSB WPR09FA459
2009	G-TTHC, Sandtoft Aerodrome, Humberside, UK. Possible engine failure led to low rotor RPM and tail boom chop.	AAIB EW/C2009/02 /04
2009	VH-HXO, 120km west of Paraburdoo, Western Australia, Australia. In-flight break and tail boom chop. Suspected caused by pilot fatigue.	ATSB AO-2009-031
2010	N522SA, Spokane, Washington, USA. Possible engine failure due to icing led to low rotor RPM and tail boom chop.	NTSB WPR10FA277
2012	G-CHZN, Ely, Cambridgeshire, UK. In flight break up and tail boom chop.	AAIB EW/C2012/01 /01
2012	N2626N, Apollo Beach, California, USA. (Preliminary) In flight break up and main rotor separated. Appears to have been mast bump.	NTSB ERA13FA070

The accident report into G-CHZN (AAIB, 2013) listed above, described a mast bump situation where the main rotor blades had separated from the helicopter. The investigation traced through the FAA/NTSB actions (as also described in this report) and listed 16 other R22 accidents from around the world going back to 1996 that they had considered to be similar in some respects. Most of them were in the USA and 6 are also listed above, but the report included 10 other similar accidents not listed above.

**ROBINSON
MODEL R22**

**SECTION 2
LIMITATIONS**

**SECTION 2
LIMITATIONS**

GENERAL

Information contained in Section 2 is approved by the Federal Aviation Administration. This section includes operating limitations, instrument markings, and basic placards required for safe operation of the helicopter, its engine, and other standard systems. This helicopter is approved under FAA Type Certificate No. H10WE as Model R22.

COLOR CODE FOR INSTRUMENT MARKINGS

- Red Indicates operating limits. Pointer should not enter red during normal operation.
- Yellow Precautionary or special operating procedure range.
- Green Normal operating range.

AIRSPEED LIMITS

NEVER-EXCEED AIRSPEED (V_{ne})

Up to 3000 feet density altitude: 102 KIAS

Above 3000 feet density altitude, see placards on page 2-11.

FAA APPROVED: 1 JUL 2005

2-1

FLIGHT AND MANEUVER LIMITATIONS

Aerobatic flight prohibited.

Low-G cyclic pushovers prohibited.

CAUTION

A pushover (forward cyclic maneuver) performed from level flight or following a pull-up causes a low-G (near weightless) condition which can result in catastrophic loss of lateral control. To eliminate a low-G condition, immediately apply gentle aft cyclic. Should a right roll commence during a low-G condition, apply gentle aft cyclic to reload rotor before applying lateral cyclic to stop the roll.

Flight prohibited with governor selected off, with exceptions for in-flight system malfunction or emergency procedures training.

Flight in known icing conditions prohibited.

Maximum operating density altitude 14,000 feet.

Alternator, RPM governor, low rotor RPM warning system, and OAT gage must be operational for dispatch.

Solo flight from right seat only.

Left seat belt must be buckled.

Minimum crew is one pilot.

Doors-off operation approved with either or both doors removed.

CAUTION

No loose items allowed in cabin during doors-off flight.

CAUTION

Avoid abrupt control inputs. They produce high fatigue stresses and could lead to a premature and catastrophic failure of a critical component.

Appendix 5: History of airworthiness directives and SFAR 73 in New Zealand

Issue date	Reference	Significant points
12 Jan 1995	FAA priority letter AD 95-02-03	Introduction of changes to R22 flight manual to limit operations in high winds, turbulence and wind shear conditions and provides recommendations to avoid main rotor stalls and mast bumping.
17 Mar 1995	AD 95-04-14 [Applies to R22 helicopters only. R44 not affected]	<p>Formalises the priority letter but adds some minor changes to wording. Intended to revise the operating limitation of the helicopter to a safer level and applies to all pilots. Prohibited flight in the R22 helicopter when:</p> <ul style="list-style-type: none"> • surface wind exceeds 25 knots or gust spread exceeds 15 knots • wind shear exists • moderate or worse turbulence is encountered. <p>Limits airspeed to between 60 knots and 0.7 Vne if inadvertently encountering turbulence.</p> <p>Adds to normal procedures' description of M/R stall and mast bumping conditions and how to avoid. Recommends max Vne is 90% rated and avoid flight at high-density altitudes, use max power-on at all times. Adds to emergency procedures with actions if experiencing low G or turbulence.</p>
25 Mar 1995	NZ CAA DCA/R22/27	AD 95-04-14 is inserted directly into New Zealand flight manual for R22 and compliance with "Limitations" section is mandatory.
27 Mar 1995 to 31 Dec 1997	SFAR 73	<p>Establishes special training requirements for R22 and R44 pilots (Robinson safety awareness training). Confirms that R22 is used for training and describes the hazards of low G and main rotor stall. Justifies the requirement for an experience threshold for the Robinson pilots. Includes the following points:</p> <ul style="list-style-type: none"> • no person may <u>manipulate the controls</u> of an R22 or R44 before completing Robinson safety awareness training. This also applies to pilots with existing helicopter licences • describes the subject matter for the Robinson safety awareness training • describes the requirements for instructors to be authorised to conduct Robinson safety awareness training. <p>Additionally, <u>no person may act as pilot-in-command</u> in an R22 unless that person has:</p> <ul style="list-style-type: none"> • at least 200 hours' helicopter total time, of which at least 50 must be in the R22, or • 10 hours' dual and endorsement from an authorised instructor that the pilot is proficient to act as pilot-in-command. In this case must also be subject to an annual flight review instead of 2

Issue date	Reference	Significant points
		<p>yearly until meets minimum experience limit.</p> <p>A person with a pilot's licence but not for rotorcraft must have a minimum of 20 hours' dual in an R22 before going solo plus a log book endorsement from an appropriately rated instructor that the person is proficient to solo an R22. This endorsement only remains valid for 90 days.</p> <p>Robinson safety awareness training must be repeated every 2 years.</p> <p>Flight reviews must be carried out in the applicable R22 or R44 and include a review of the theory and practical skills central to the Robinson safety awareness training.</p>
14 Jul 1995	AD 95-11-09 for R22 and AD 95-11-10 for R44	Low "G" cyclic pushover manoeuvres prohibited.
14 Sep 1995	NZ CAA GEN A113/95	<p>Implements Robinson special training requirements for all persons who seek to manipulate the controls or act as pilots-in-command of Robinson R22 and R44 helicopters.</p> <p>Repeats SFAR 73 in a clearer format and in addition to any existing Part 61 requirements.</p> <p>Has not been transferred into subsequent amendments of Civil Aviation Rules Part 61. No longer in force.</p>
26 Jan 1996 (permanent)	AD 95-26-04 for R22 helicopters and AD 95-26-05 issued for R44 with same conditions	<p>Supersedes AD 95-04-14 with minor changes after feedback. Applies to pilot manipulating the controls who must have also completed Robinson safety awareness training.</p> <p>Repeats the same conditions as previous AD for prohibiting flight when wind or turbulence is greater than specified limits, but now only applies to pilots with less than the minimum R22 experience. The limits for high-altitude flight and wind shear are removed.</p> <p>The new conditions for operations in wind or turbulence are highlighted in yellow.</p> <p>Unless the person <u>manipulating the controls</u> in an R22 has at least 200 hours' helicopter total time, of which at least 50 must be in the R22, they are prohibited from flying the R22 helicopter when:</p> <ul style="list-style-type: none"> • surface wind exceeds 25 knots or • the gust spread exceeds 15 knots, and • if moderate turbulence or worse is encountered, continued flight is prohibited. <p>All pilots must limit airspeed to between 60 knots and 0.7 Vne if inadvertently encountering turbulence.</p> <p>Adds to normal procedures a description of main rotor stall and mast bumping conditions and how to avoid. The</p>

Issue date	Reference	Significant points
		<p>avoidance actions are:</p> <ol style="list-style-type: none"> 1. Maintain cruise speed between 60 knots and less than 90% of rated Vne 2. Use max power-on at all times during powered flight 3. Avoid sideslip and maintain trimmed flight at all times 4. Avoid large, rapid forward cyclic movements in forward flight and abrupt control inputs in turbulence <p>Also adds to the “Emergency” Procedures” a description of how to react to low G and turbulence.</p>
16 Feb 1996	NZ CAA DCA/R22/27A	<p>Revises New Zealand flight manual for R22 by:</p> <ul style="list-style-type: none"> • adding one page of CAA text to the “Limitations” section. Compliance mandatory • inserting AD 95-26-04 changes in the “Normal Procedures” and “Emergency Procedures” sections.
31 Dec 1997 to 31 Dec 2002	SFAR 73-1	<p>Clarifies the previous version with replacement text after feedback and, as the FAA recognised that the R44 was more stable than the R22, experience in the R22 can be credited towards the minimum requirement for the R44.</p> <p>Extends the SFAR 73 validity to 2002.</p>
28 Aug 1998	NZ CAA DCA/R22/27B	<p>Revises New Zealand flight manual for R22 by:</p> <ul style="list-style-type: none"> • adding 3 pages of CAA text to the “Limitations” section. Compliance mandatory • inserting AD 95-26-04 changes in the “Normal Procedures” and “Emergency Procedures” sections. • prohibiting low G pushovers • changing the experience limitations for conditions of wind and turbulence from being applicable to the pilot manipulating the controls to the pilot-in-command.

Issue date	Reference	Significant points
31 Dec 2002 to 31 Mar 2008	SFAR 73-1	<p>FFA considers feedback from industry on several points.</p> <ol style="list-style-type: none"> 1. Should the R44 be excluded? No, it must remain covered by this SFAR. 2. Should flight training be allowed for ab-initio pilots before completing Robinson safety awareness training? No, decided that continuous awareness training was preferable as the student was able to absorb it. 3. Should the annual flight review be extended to the normal 2 years? No, it is to remain at one year as described in the SFAR 73 for pilots with experience less than the minimum level. 4. Should the 200-hour limit be reduced to 150? No. 5. Should the life of this SFAR only be extended 2 years? No. <p>Extends the SFAR 73 to 2008.</p>
6 Jul 2004	AD 95-26-05 R1	Rescinds AD 95-26-05 for R44 helicopters.
26 Jul 2007	NZ CAA DCA/R22/27C	<p>Revises New Zealand flight manual for R22 by:</p> <ul style="list-style-type: none"> • replacing 3 pages of CAA text into the “Limitations” section that includes some of the general content of SFAR 73. Compliance mandatory • inserting AD 95-26-04 changes in the “Normal Procedures” and “Emergency Procedures” sections.
31 Mar 2008 to 30 Jun 2009	SFAR 73	The SFAR 73 is reformatted to be more readable and extended to 2009, but the content is unchanged.
29 Jun 2009 Permanent	SFAR 73-2	<p>FAA reviewed the NTSB accident data between 2005 and 2008 and found there were nearly 4 times more R22s/R44s in operation compared with other 2-bladed light helicopters. When compared on a per 100 000 hours of flight time, the accident rate for the R22/R44 is 10.48 compared with 7.44 for the other types taken as a group, therefor justifying continuing with the Robinson safety awareness training as required under SFAR 73.</p> <p>Decided to make SFAR 73 permanent.</p> <p>The regulation was reformatted with clearer presentation and readability.</p>

Appendix 6: The current version of SFAR 73

RGL Home

Special Federal Aviation Regulation

14 CFR Parts 61
Docket No. FAA-2002-13744; SFAR No. 73

Robinson R-22/R-44 Special Training and Experience Requirements

Regulatory Information

1. Applicability. Under the procedures prescribed herein, this SFAR applies to all persons who seek to manipulate the controls or act as pilot in command of a Robinson model R-22 or R-44 helicopter. The requirements stated in this SFAR are in addition to the current requirements of part 61.

2. Required training, aeronautical experience, endorsements, and flight review.

(a) Awareness Training:

- (1) Except as provided in paragraph (a)(2) of this section, no person may manipulate the controls of a Robinson model R-22 or R-44 helicopter after March 27, 1995, for the purpose of flight unless the awareness training specified in paragraph (a)(3) of this section is completed and the person's logbook has been endorsed by a certified flight instructor authorized under paragraph (b)(5) of this section.
- (2) A person who holds a rotorcraft category and helicopter class rating on that person's pilot certificate and meets the experience requirements of paragraph (b)(1) or paragraph (b)(2) of this section may not manipulate the controls of a Robinson model R-22 or R-44 helicopter for the purpose of flight after April 26, 1995, unless the awareness training specified in paragraph (a)(3) of this section is completed and the person's logbook has been endorsed by a certified flight instructor authorized under paragraph (b)(5) of this section.
- (3) Awareness training must be conducted by a certified flight instructor who has been endorsed under paragraph (b)(5) of this section and consists of instruction in the following general subject areas:
 - (i) Energy management;
 - (ii) Mast bumping;
 - (iii) Low rotor RPM (blade stall);
 - (iv) Low G hazards; and
 - (v) Rotor RPM decay.

(4) A person who can show satisfactory completion of the manufacturer's safety course after January 1, 1994, may obtain an endorsement from an FAA aviation safety inspector in lieu of completing the awareness training required in paragraphs (a)(1) and (a)(2) of this section.

(b) Aeronautical Experience:

- (1) No person may act as pilot in command of a Robinson model R-22 unless that person:
 - (i) Has had at least 200 flight hours in helicopters, at least 50 flight hours of which were in the Robinson R-22; or
 - (ii) Has had at least 10 hours dual instruction in the Robinson R-22 and has received an endorsement from a certified flight instructor authorized under paragraph (b)(5) of this section that the individual has been given the training required by this paragraph and is proficient to act as pilot in command of an R-22. Beginning 12 calendar months after the date of the endorsement, the individual may not act as pilot in command unless the individual has completed a flight review in an R-22 within the preceding 12 calendar months and obtained an endorsement for that flight review. The dual instruction must include at least the following abnormal and emergency procedures flight training:
 - (a) Enhanced training in autorotation procedures;
 - (b) Engine rotor RPM control without the use of the governor;
 - (c) Low rotor RPM recognition and recovery; and
 - (d) Effects of low G maneuvers and proper recovery procedures.
- (2) No person may act as pilot in command of a Robinson R-44 unless that person--
 - (i) Has had at least 200 flight hours in helicopters, at least 50 flight hours of which were in the Robinson R-44. The pilot in command may credit up to 25 flight hours in the Robinson R-22 toward the 50 hour requirement in the Robinson R-44; or
 - (ii) Has had at least 10 hours dual instruction in a Robinson helicopter, at least 5 hours of which must have been accomplished in the Robinson R-44 helicopter and has received an endorsement from a certified flight instructor authorized under paragraph (b)(5) of this section that the individual has been given the training required by this paragraph and is proficient to act as pilot in command of an R-44. Beginning 12 calendar months after the date of the endorsement, the individual may not act as pilot in command unless the individual has completed a flight review in a Robinson R-44 within the preceding 12 calendar months and obtained an endorsement for that flight review. The dual instruction must include at least the following abnormal and emergency procedures flight training--
 - (A) Enhanced training in autorotation procedures;
 - (B) Engine rotor RPM control without the use of the governor;
 - (C) Low rotor RPM recognition and recovery; and
 - (D) Effects of low G maneuvers and proper recovery procedures.
- (3) A person who does not hold a rotorcraft category and helicopter class rating must have had at least 20 hours of dual instruction in a Robinson R-22 helicopter prior to operating it in solo flight. In addition, the person must obtain an endorsement from a certified flight instructor authorized under paragraph (b)(5) of this section that instruction has been given in those maneuvers and procedures, and the instructor has found the applicant proficient to solo a Robinson R-22. This endorsement is valid for a period of 90 days. The dual instruction must include at least the following abnormal and emergency procedures flight training:
 - (i) Enhanced training in autorotation procedures;

- (ii) Engine rotor RPM control without the use of the governor,
 - (iii) Low rotor RPM recognition and recovery, and
 - (iv) Effects of low G maneuvers and proper recovery procedures.
- (4) A person who does not hold a rotorcraft category and helicopter class rating must have had at least 20 hours of dual instruction in a Robinson R-44 helicopter prior to operating it in solo flight. In addition, the person must obtain an endorsement from a certified flight instructor authorized under paragraph (b)(5) of this section that instruction has been given in those maneuvers and procedures, and the instructor has found the applicant proficient to solo a Robinson R-44. This endorsement is valid for a period of 90 days. The dual instruction must include at least the following abnormal and emergency procedures flight training:
- (i) Enhanced training in autorotation procedures,
 - (ii) Engine rotor RPM control without the use of the governor,
 - (iii) Low rotor RPM recognition and recovery, and
 - (iv) Effects of low G maneuvers and proper recovery procedures.
- (5) No certificated flight instructor may provide instruction or conduct a flight review in a Robinson R-22 or R-44 unless that instructor--
- (i) Completes the awareness training in paragraph 2(a) of this SFAR,
 - (ii) For the Robinson R-22, has had at least 200 flight hours in helicopters, at least 50 flight hours of which were in the Robinson R-22, or for the Robinson R-44, has had at least 200 flight hours in helicopters, 50 flight hours of which were in Robinson Helicopters. Up to 25 flight hours of Robinson R-22 flight time may be credited toward the 50 hour requirement.
 - (iii) Has completed flight training in a Robinson R-22, R-44, or both, on the following abnormal and emergency procedures--
 - (A) Enhanced training in autorotation procedures;
 - (B) Engine rotor RPM control without the use of the governor;
 - (C) Low rotor RPM recognition and recovery; and
 - (D) Effects of low G maneuvers and proper recovery procedures.
 - (iv) Has been authorized by endorsement from an FAA aviation safety inspector or authorized designated examiner that the instructor has completed the appropriate training, meets the experience requirements and has satisfactorily demonstrated an ability to provide instruction on the general subject areas of paragraph 2(a)(3) of this SFAR, and the flight training identified in paragraph 2(b)(5)(iii) of this SFAR.]

(c) Flight Review:

- (1) No flight review completed to satisfy Sec. 61.56 by an individual after becoming eligible to function as pilot in command in a Robinson R-22 helicopter shall be valid for the operation of R-22 helicopter unless that flight review was taken in an R-22.
- (2) No flight review completed to satisfy Sec. 61.56 by individual after becoming eligible to function as pilot in command in a Robinson R-44 helicopter shall be valid for the operation of R-44 helicopter unless that flight review was taken in the R-44.
- (3) The flight review will include a review of the awareness training subject areas of paragraph 2(a)(3) of this SFAR and the flight training identified in paragraph 2(b) of this SFAR.

(d) Currency Requirements: No person may act as pilot in command of a Robinson model R-22 or R-44 helicopter carrying passengers unless the pilot in command has met the recency of flight experience requirements of Sec. 61.57 in an R-22 or R-44, as appropriate.

§3. Expiration date. This SFAR No. 73 shall remain in effect until it is revised or rescinded.]

EFFECTIVE DATE:
29/09/2009

TERMINATION DATE:

► **Comments**

▼ **Document History**

Notice of Proposed Rulemaking Actions:

Other Final Rule Actions:

- Final Rule; Amendment No. **SFAR 73**; Published on 3/1/1995.
- Final Rule; Amendment No. **61.102**; Published on 4/4/1997.
- Final Rule; Amendment No. **SFAR 73-1**; Published on 1/7/1998.
- Final Rule; Amendment No. **SFAR 73-1**; Published on 1/2/2003.
- Final Rule; Amendment No. **61-120**; Published on 4/1/2008.
- Final Rule; Amendment No. **SFAR 73-2**; Published on 5/29/2009.



Safety Notice SN-11

Issued: Oct 82 Rev: Nov 00

LOW-G PUSHOVERS - EXTREMELY DANGEROUS

Pushing the cyclic forward following a pull-up or rapid climb, or even from level flight, produces a low-G (weightless) flight condition. If the helicopter is still pitching forward when the pilot applies aft cyclic to reload the rotor, the rotor disc may tilt aft relative to the fuselage before it is reloaded. The main rotor torque reaction will then combine with tail rotor thrust to produce a powerful right rolling moment on the fuselage. With no lift from the rotor, there is no lateral control to stop the rapid right roll and mast bumping can occur. Severe in-flight mast bumping usually results in main rotor shaft separation and/or rotor blade contact with the fuselage.

The rotor must be reloaded before lateral cyclic can stop the right roll. To reload the rotor, apply an immediate gentle aft cyclic, but avoid any large aft cyclic inputs. (The low-G which occurs during a rapid autorotation entry is not a problem because lowering collective reduces both rotor lift and rotor torque at the same time.)

Never attempt to demonstrate or experiment with low-G maneuvers, regardless of your skill or experience level. Even highly experienced test pilots have been killed investigating the low-G flight condition. Always use great care to avoid any maneuver which could result in a low-G condition. Low-G mast bumping accidents are almost always fatal.

NEVER PERFORM A LOW-G PUSHOVER!!



Safety Notice SN-32

Issued: Mar 98

HIGH WINDS OR TURBULENCE

Flying in high winds or turbulence should be avoided but, if unexpected turbulence is encountered, the following procedures are recommended:

- 1) Reduce airspeed to between 60 or 70 KIAS.
- 2) Tighten seat belt and firmly rest right forearm on right leg to prevent unintentional control inputs.
- 3) Do not overcontrol. Avoid large or abrupt control movements. Allow aircraft to go with the turbulence, then restore level flight with smooth gentle control inputs.
- 4) Leave governor on and do not chase RPM or airspeed. Momentary RPM or airspeed excursions are to be expected.
- 5) Avoid flying on the downwind side of hills, ridges, or tall buildings where the turbulence will likely be most severe.
- 6) Never fly into a blind or box canyon during high winds.

Safety Notice SN-24

Issued: Sep 86 Rev: Jun 94

LOW RPM ROTOR STALL CAN BE FATAL

Rotor stall due to low RPM causes a very high percentage of helicopter accidents, both fatal and non-fatal. Frequently misunderstood, rotor stall is not to be confused with retreating tip stall which occurs only at high forward speeds when stall occurs over a small portion of the retreating blade tip. Retreating tip stall causes vibration and control problems, but the rotor is still very capable of providing sufficient lift to support the weight of the helicopter.

Rotor stall, on the other hand, can occur at any airspeed and when it does, the rotor stops producing the lift required to support the helicopter and the aircraft literally falls out of the sky. Fortunately, rotor stall accidents most often occur close to the ground during takeoff or landing and the helicopter falls only four or five feet. The helicopter is wrecked but the occupants survive. However, rotor stall also occurs at higher altitudes and when it happens at heights above 40 or 50 feet AGL it is most likely to be fatal.

Rotor stall is very similar to the stall of an airplane wing at low airspeeds. As the airspeed of an airplane gets lower, the nose-up angle, or angle-of-attack, of the wing must be higher for the wing to produce the lift required to support the weight of the airplane. At a critical angle (about 15 degrees), the airflow over the wing will separate and stall causing a sudden loss of lift and a very large increase in drag. The airplane pilot recovers by lowering the nose of the airplane to reduce the wing angle-of-attack below stall and adds power to recover the lost airspeed.

The same thing happens during rotor stall with a helicopter except it occurs due to low rotor RPM instead of low airspeed. As the RPM of the rotor gets lower, the angle-of-attack of the rotor blades must be higher to generate the lift required to support the weight of the helicopter. Even if the collective is not raised by the pilot to provide the higher blade angle, the helicopter will start to descend until the

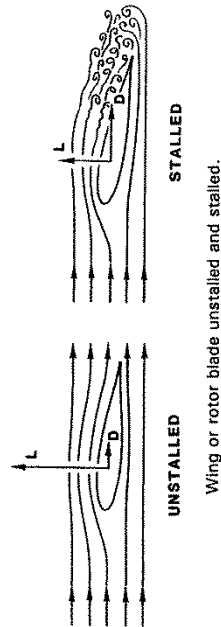

Safety Notice SN-24 (continued)

upward movement of air to the rotor provides the necessary increase in blade angle-of-attack. As with the airplane wing, the blade airfoil will stall at a critical angle, resulting in a sudden loss of lift and a large increase in drag. The increased drag on the blades acts like a huge rotor brake causing the rotor RPM to rapidly decrease, further increasing the rotor stall. As the helicopter begins to fall, the upward rushing air continues to increase the angle-of-attack on the slowly rotating blades, making recovery virtually impossible, even with full down collective.

When the rotor stalls, it does not do so symmetrically because any forward airspeed of the helicopter will produce a higher airflow on the advancing blade than on the retreating blade. This causes the advancing blade to stall first, allowing it to dive as it goes aft while the retreating blade is still climbing as it goes forward. The resulting low aft blade and high forward blade become a rapid aft tilting of the rotor disc sometimes referred to as "rotor blow-back". Also, as the helicopter begins to fall, the upward flow of air under the tail surfaces tends to pitch the aircraft nose-down. These two effects, combined with aft cyclic by the pilot attempting to keep the nose from dropping, will frequently allow the rotor blades to blow back and chop off the tailboom as the stalled helicopter falls. Due to the magnitude of the forces involved and the flexibility of rotor blades, rotor teeter stops will not prevent the boom chop. The resulting boom chop, however, is academic, as the aircraft and its occupants are already doomed by the stalled rotor before the chop occurs.

Appendix 8: Robinson R22 helicopter accident data comparison

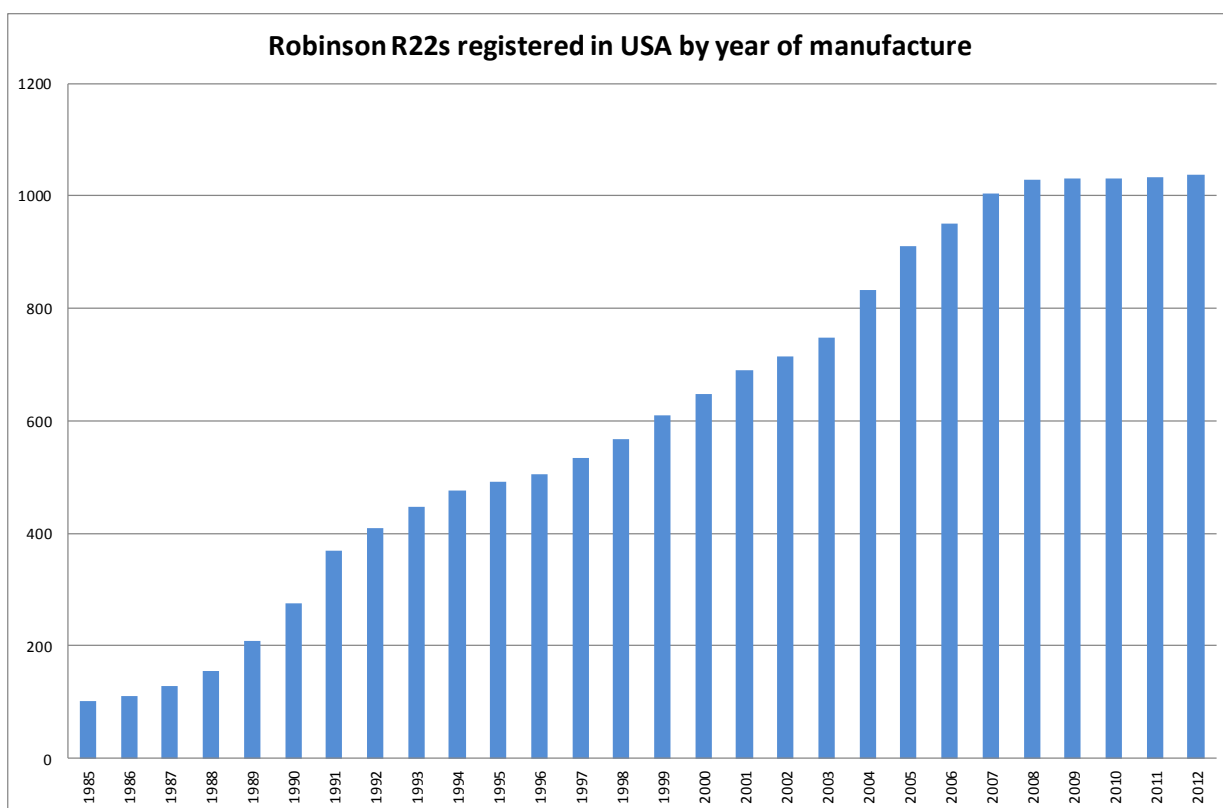
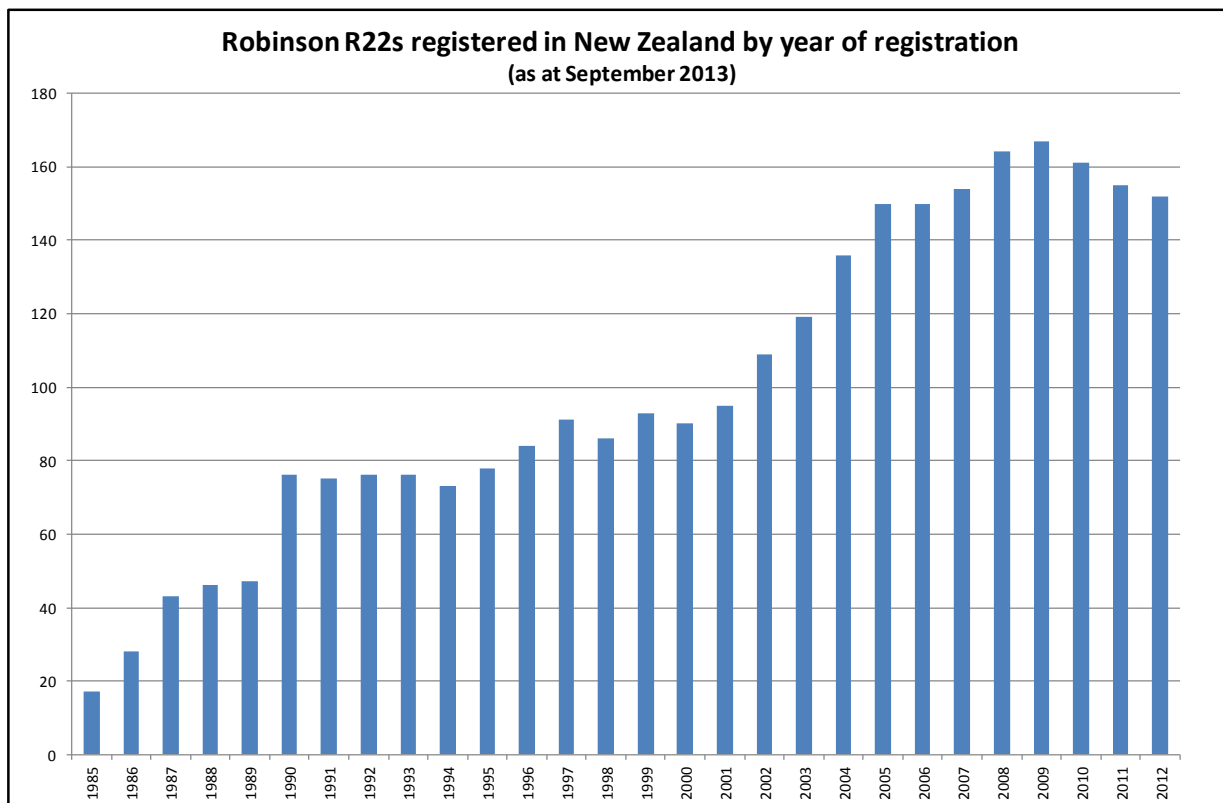

Robinson R22 fatal accidents in New Zealand

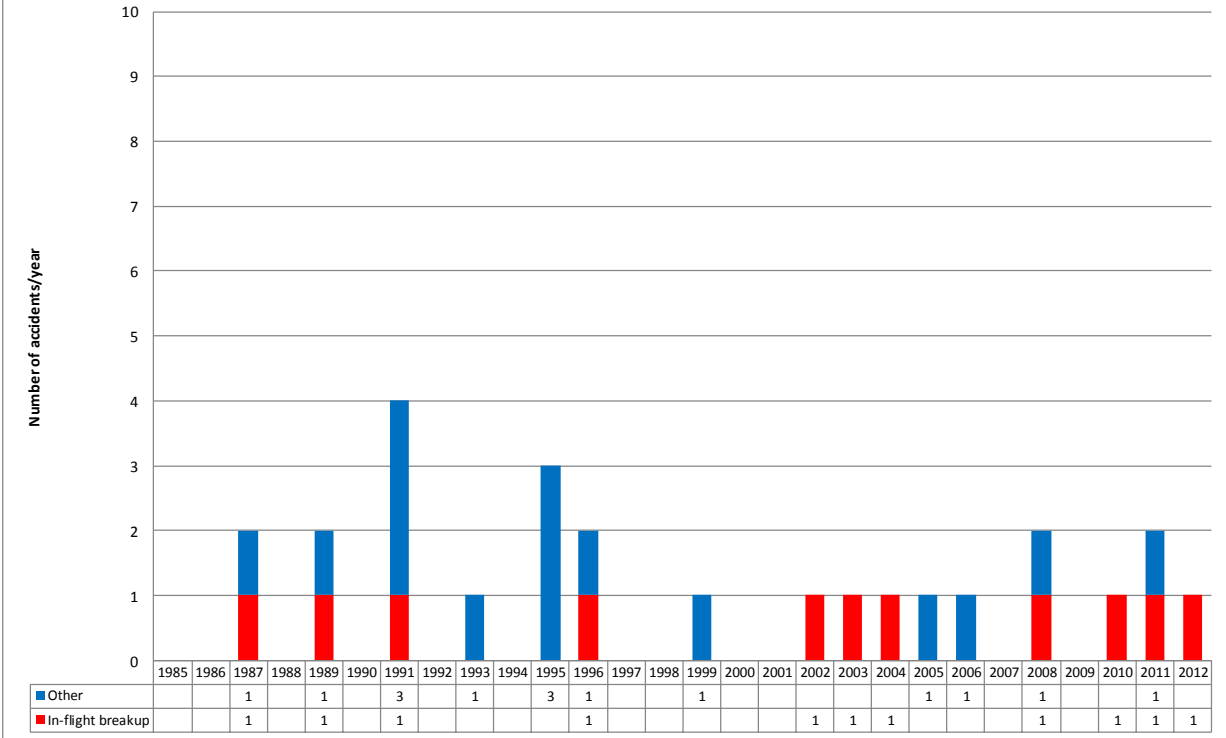

Robinson R22 fatal accidents in USA

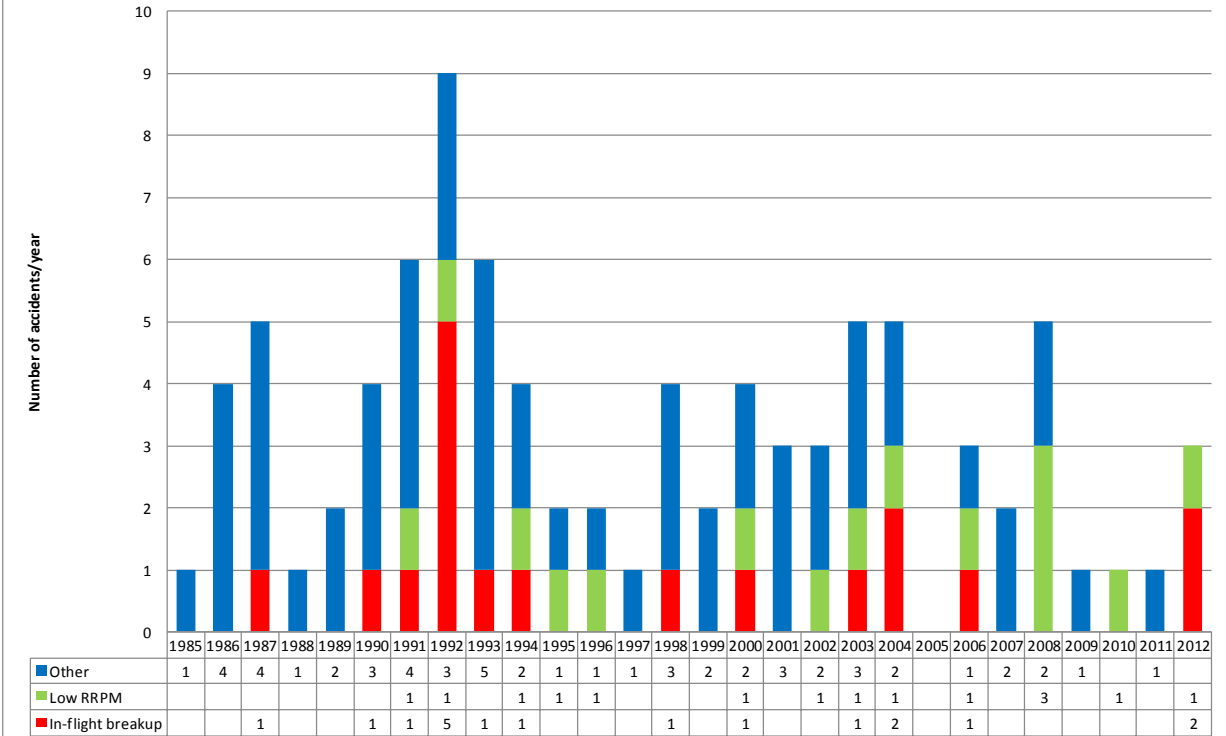



**Recent Aviation Occurrence Reports published by
the Transport Accident Investigation Commission
(most recent at top of list)**

- 12-001 Hot-air balloon collision with power lines, and in-flight fire, near Carterton, 7 January 2012
- 11-004 Piper PA31-350 Navajo Chieftain, ZK-MYS, landing without nose landing gear extended, Nelson Aerodrome, 11 May 2011
- 11-005 Engine compressor surges, 18 September 2011
- 11-001 Bell Helicopter Textron 206L-3, ZK-ISF, Ditching after engine power decrease, Bream Bay, Northland, 20 January 2011
- 11-002 Bombardier DHC-8-311, ZK-NEQ, Landing without nose landing gear extended Woodbourne (Blenheim) Aerodrome, 9 February 2011
- 10-010 Bombardier DHC-8-311, ZK-NEB, landing without nose landing gear extended, Woodbourne (Blenheim) Aerodrome, 30 September 2010
- 12-001 Interim Factual: Cameron Balloons A210 registration ZK-XXF, collision with power line and in-flight fire, 7 January 2012
- 10-009 Walter Fletcher FU24, ZK-EUF, loss of control on take-off and impact with terrain, Fox Glacier aerodrome, South Westland, 4 September 2010
- 10-007 Boeing 737-800, ZK-PBF and Boeing 737-800, VH-VXU airspace incident, near Queenstown Aerodrome, 20 June 2010
- 10-005 Cessna A152, ZK-NPL and Robinson R22 Beta, ZK-HIE near-collision. New Plymouth Aerodrome, 10 May 2010
- 10-003 Cessna C208 Caravan ZK-TZR engine fuel leak and forced landing, Nelson, 10 February 2010
- 10-006 Runway Incursion, Dunedin International Airport, 25 May 2010
- 10-001 Aerospatiale-Alenia ATR 72-212A, ZK-MCP and ZK-MCJ, severe turbulence encounters, about 50 nautical miles north of Christchurch, 30 December 2009
- 09-002 ZK-DGZ, Airborne XT-912, 9 February 2009, and commercial microlight aircraft operations

Price \$24.00

ISSN 1179-9080 (Print)
ISSN 1179-9099 (Online)