



## AUCKLAND HARBOUR BRIDGE ACTIVE MODE PROVISION – TRAFFIC IMPACT ASSESSMENT PHASE 2

s 9(2)(a)

11 JULY 2022

REVISION 3

## Document Control

### Report

This report has been prepared for the benefit of the NZ Transport Agency (NZTA). No liability is accepted by the Auckland System Management Alliance (ASM) or sub-consultant of the ASM, with respect to its use by any other person.

### Disclaimer

The NZ Transport Agency has endeavoured to ensure material in this document is technically accurate and reflects legal requirements. However, the document does not override governing legislation. The NZ Transport Agency does not accept liability for any consequences arising from the use of this document. If the user of this document is unsure whether the material is correct, they should refer directly to the relevant legislation and contact the NZ Transport Agency.

### Quality Assurance

QUALITY ASSURANCE STATEMENT	
Owner: s 9(2)(a)	Prepared by: s 9(2)(a)
Review and QA approval by: s 9(2)(a)	

### Revision Control

Revision	Name	Date	Description
1	s 9(2)(a)	28/02/2022	Draft report
2		03/03/2022	Updated draft <ul style="list-style-type: none"> <li>- Added sections 5.1.1 and 5.1.6</li> <li>- Added Figures 14, 21 and 34</li> <li>- Figures 25, 25 and 26 added to section 5.1.7 along with description of top-down sanity checks.</li> <li>- Section 7 – Further Observations added</li> <li>- Notes in Table 3 updated</li> <li>- Appendix E added</li> <li>- Speed scale added to Figures 28, 29, 30, 41, 45. Speed scale updated on Figures 4, 47 and throughout Appendix E.</li> <li>- Legend on Figure 3 updated.</li> <li>- minor re-wording and corrections for typos throughout.</li> </ul>
3	s 9(2)(a)	11/07/2022	Final Report <ul style="list-style-type: none"> <li>- Addition to section 7 of demand reductions and remaining congestion during Sep-2020 extended period of 2-Lane closures on AHB including addition of Figures 48, 49 and 50. Related revision of Figure 51 and associated commentary in the text.</li> <li>- Additional minor changes to rev2 in Executive Summary, sections 4.2, 5.2, 5.3, 5.4, 6.2, 6.3, 6.4, 7 and 8</li> <li>- Addition of Appendices B and D.</li> </ul>

RELEASED UNDER THE OFFICIAL INFORMATION ACT 1982

## EXECUTIVE SUMMARY

The removal of one or two lanes from the Auckland Harbour Bridge (AHB) to provide an active mode facility will significantly change the dynamics of how the Auckland motorway system operates. The current operational strategy for the motorway network relies on the AHB having some spare capacity in at least one direction at all times of day (through strategic bottlenecks some way upstream on each approach). This protects both regional mobility for general traffic (including large numbers of commercial goods vehicles) as well as the level of service for the Rapid Transit Network which crosses the AHB in both directions. The loss of one or two lanes will undermine this function and result in the AHB (and St Mary's Bay) becoming a critical bottleneck on the motorway system.

Loss of two general traffic lanes would have a severe impact on the operation of the motorway and strategic arterial networks. Even allowing for highly optimistic behaviour change assumptions that would remove over 17,000 vehicles per day from the AHB (including more than 2,000 vehicles per hour for three hours in each peak) this would fail to prevent close to a doubling of motorway congestion hours along with a doubling of the total length of on-ramp queues (compared to 2019 conditions). It is an open question whether additional trip suppression would occur to attenuate these impacts, however suppression of sufficient trips to significantly reduce the resulting congestion would itself impose a heavy impact on the region's economy. Even the assumed reduction of 17,000 vehicles per day would reduce the AADT on the bridge to levels not seen since the year after northern busway opened, 15 years ago.

The impacts of the 1-Lane option are relatively modest compared to the 2-Lane option under typical (50<sup>th</sup> percentile) demand but are still significant from a customer perspective. No adverse impacts on traffic are expected during the AM peak (although the reliability of services on the Northern Busway maybe adversely affected). However, the loss of one lane, for one or other direction at all times of day results a capacity shortfall during the middle of the day that is likely to result in traffic backlogs that build up daily and extend into the PM peak (see graph below).



Although relatively modest to begin with the resulting backlog on the northern motorway will build rapidly into the afternoon. Active management to mitigate this by delaying the AHB lane switch as late as possible each day would mitigate this but would also risk the opposing backlog on the southern motorway triggering a cascading impact on traffic conditions on that corridor into and through the PM peak (based on the sensitivity of the critical bottleneck at Green Lane). This situation becomes more unstable on days when traffic demands are high and presents a risk of a significant deterioration in network reliability for the busiest road corridor and freight route in New Zealand. The following diagram (overleaf) illustrates how extensive these impacts could be on high demand days on the network (90<sup>th</sup> percentile demands, likely to occur around 25 times per year). Note the latest modelling for a congestion charge (based on AM and PM period charges only) indicates a 6%-7% increase in inter-peak traffic which could exacerbate this situation further.

Northern Mway (southbound)

Southern Mway (northbound)

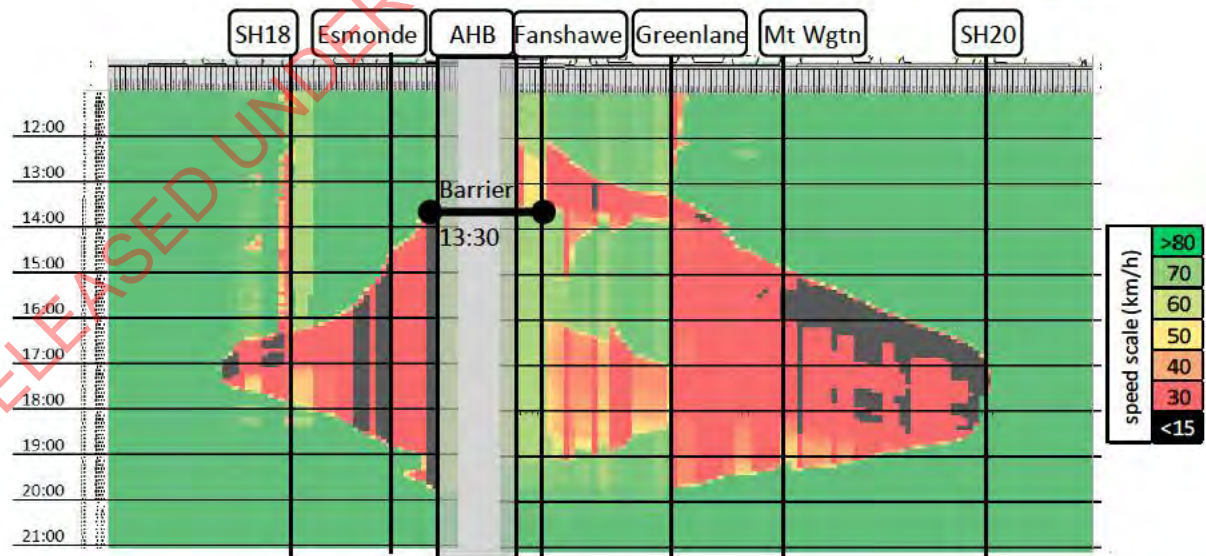
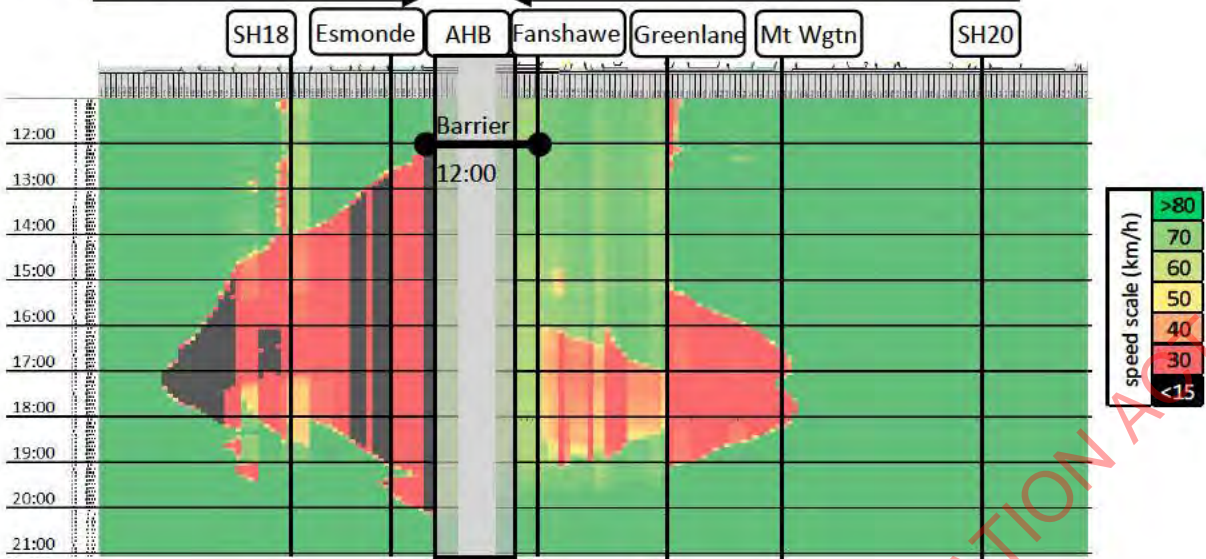

RELEASED UNDER THE OFFICIAL INFORMATION ACT 1982

The Western Ring Route alternative to SH1 via SH18, SH16 and SH20 does not provide its function very effectively. As well as being much longer it suffers from severe capacity constraints in a number of locations (most critically on SH16 westbound and eastbound) and the ramp metering system does not currently manage SH16 inflows effectively. This means at peak times when already congested it does not provide a viable alternative for customers unless congestion on SH1 is extremely bad. When SH1 is extremely congested any re-distribution of traffic to SH16 or SH20 rapidly leads to these corridors also becoming severely congested. The net result of this redistribution of traffic would be to significantly impact overall regional accessibility. While this would be an issue daily under the 2-Lane option it would also significantly impact network resilience with the 1-Lane option, under circumstances such as a temporary lane-blocking incident on the AHB (a situation that occurs once every few weeks).

The loss of resilience associated with the 1-Lane option could be partially mitigated through minor improvements for general traffic operation to address key capacity pinch-points and ramp metering (especially on SH16). A number of potential projects to do this have already been submitted by the ASM to the Auckland Optimisation Programme.

The level of traffic demand reduction required to avoid network traffic congestion impacts entirely on all but the busiest days does not seem credible through mode shift, trip rerouting and re-timing alone based on the associated reduction in AHB AADT required. Additional demand management measures of a severity necessary to achieve the large-scale permanent suppression (cancellation) of cross-harbour trips needed to avoid these impacts would likely have significant economic consequences for the Auckland region.

RELEASED UNDER THE OFFICIAL INFORMATION ACT 1982

EXECUTIVE SUMMARY.....	3
1. INTRODUCTION.....	7
1.1 Purpose.....	7
1.2 Scope.....	7
1.3 Previous Assessment.....	7
2. AUCKLAND HARBOUR BRIDGE – OPERATIONAL CONTEXT.....	8
2.1 Network Operational Strategy and the role of the AHB.....	8
2.2 AHB Current Operation – Traffic Demand and Capacity.....	10
2.3 COVID-19 and demand changes expected in the coming years.....	14
3. PROPOSED OPTIONS TO BE FURTHER ASSESSED.....	18
4. ASSESSMENT METHODOLOGY.....	19
4.1 Uncertainty and Constraints.....	19
4.2 Methodology.....	19
4.3 Limitations.....	21
5. TIER TWO ASSESSMENT.....	22
5.1 Traffic Demands.....	22
5.2 Traffic Capacity.....	30
5.3 Network Traffic and Customer Journey impacts.....	31
5.4 Outcome of Tier Two Assessment.....	35
6. TIER THREE ASSESSMENT.....	36
6.1 Traffic Demands.....	36
6.2 Traffic Capacity.....	39
6.3 Network Traffic and Customer Journey impacts.....	41
6.4 Outcome of Tier Three Assessment.....	50
7. FURTHER OBSERVATIONS.....	51
8. CONCLUSIONS.....	55
APPENDIX A - TOOLS TO PREDICT TRAFFIC IMPACTS...AND THEIR LIMITATIONS.....	56
APPENDIX B – AHB TRAFFIC DATA SOURCES.....	59
APPENDIX C – BREAKDOWN OF DEMAND REDUCTIONS USED.....	63
APPENDIX D – THE DEFINITION AND MEASUREMENT OF TRAFFIC CAPACITY.....	69
APPENDIX E – SUMMARY OUTPUTS FROM TIER TWO AND THREE ASSESSMENTS.....	80

RELEASED UNDER THE OFFICIAL INFORMATION ACT 1982

## 1. INTRODUCTION

### 1.1 Purpose

The purpose of this report is to inform Waka Kotahi and its operating partners of the likely impacts on traffic of introducing a provision for active modes on the Auckland Harbour Bridge (AHB) that would require reallocation of either one or two lanes of the southbound (eastern) clip-on.

This assessment is a follow up to a previous investigation undertaken in May and June 2021.

### 1.2 Scope

The scope covers

1. An estimate of traffic reduction on harbour bridge with following influences
  - a. Mode shift to active modes
  - b. Mode shift to PT
  - c. Working from Home
  - d. Trip re-routing and re-timing
2. Selection of “best-estimated demands” on the harbour bridge for each option.
3. Evaluation of overall magnitude of congestion, broader impacts on the motorway network, impacts on customer journeys, and likely impact on network resilience.

The assessment uses the best available operational models and data. A cautious approach has been used to incorporate recovery of traffic from COVID-19 restrictions. A risk-based approach has been employed accounting for uncertainties and opportunities to set ranges of minimum and maximum demands in short-term implementation scenarios.

This document has been developed as a reference traffic impact assessment, to enable further discussion of possible tactical operations for the enablement of active modes across the Auckland Harbour Bridge. The elements discussed in this document are explorative and have been developed for the purpose of discussion only.

### 1.3 Previous Assessment

The previous assessment considered a wide range of options at a preliminary level only. This assessment carries forward two of the options selected from the previous assessment for more detailed consideration. The relationship between the assessment documented in this report and the previous assessment is explained further in section 4.

## 2. AUCKLAND HARBOUR BRIDGE – OPERATIONAL CONTEXT

### 2.1 Network Operational Strategy and the role of the AHB

The Auckland Harbour Bridge (AHB) is part of the Auckland urban motorway system, which comprises five motorway corridors that directly interconnect with each other: SH1 northern; SH1 southern; SH16; SH18 and SH20 (with spurs SH20A and SH20B connecting to the airport).

SH1 is the spine of the motorway system running south from Puhoi via the North Shore, Auckland City Centre and Manukau to Bombay where it enters the Waikato region. The Western Ring Route (WRR) is an alternative to the SH1 spine and comprises SH18 between the North Shore and Westgate, part of SH16, and SH20<sup>1</sup>. Both SH1 and the WRR have Important national strategic roles in facilitating the movement of people, goods and services within the greater Upper North Island. With the completion of the Northern Corridor Improvements (NCI) project at the SH18 and SH1 northern interchange, all connections between corridors will be via dedicated motorway-to-motorway links.

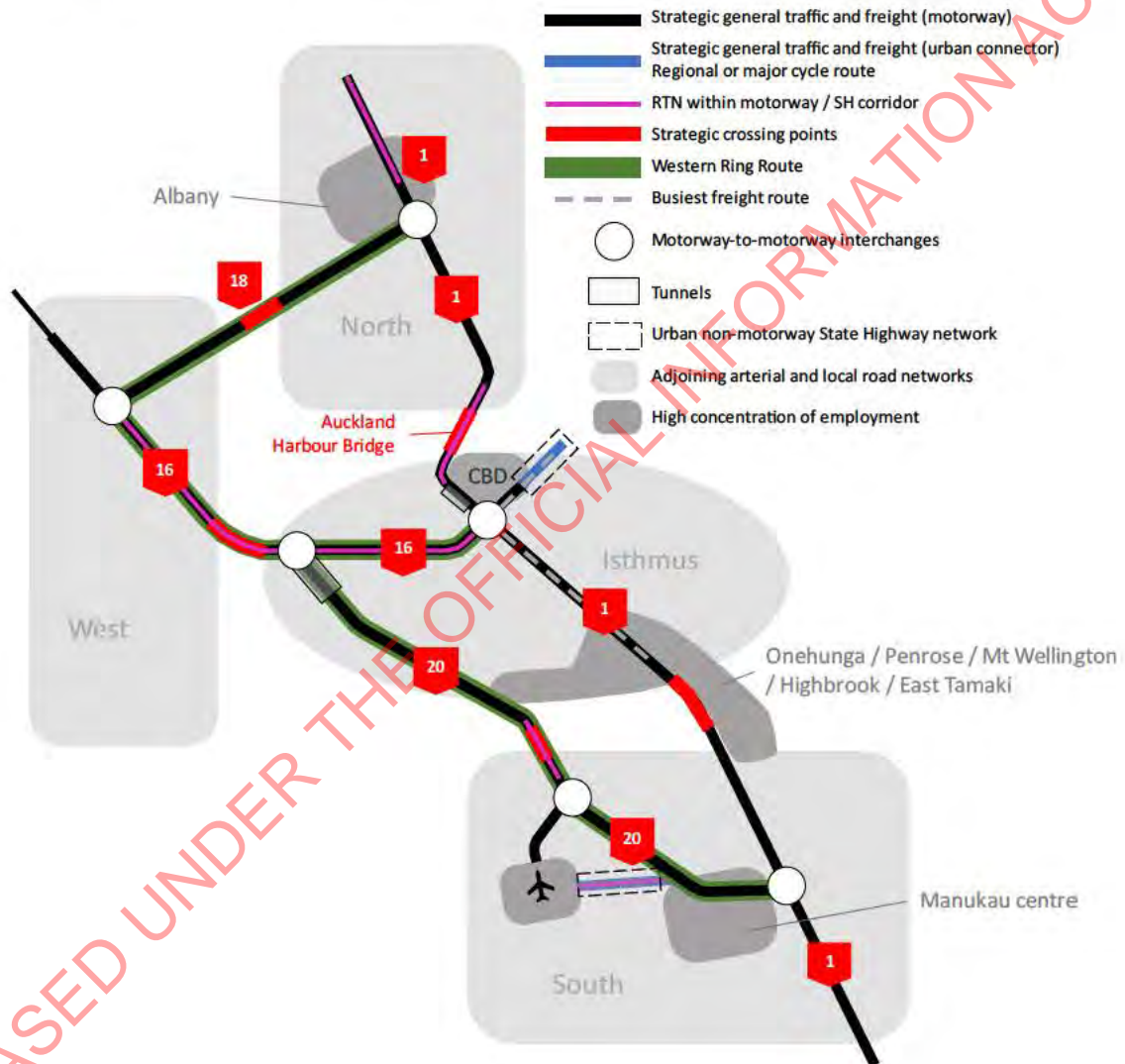

Figure 1 - Auckland motorway network summary of network function

Auckland's unique geography means the region naturally divides into four main sub-regional sectors separated by bodies of water that reflect the old pre-Auckland Council Territorial Local Authority boundaries: North; West; Isthmus and South. It is operationally significant that the motorway network provides the primary (and in some cases the only) road connectivity between the regional sectors via five strategic crossing locations. The Auckland Harbour Bridge forms

<sup>1</sup> Note that while SH16 between the CBD and where it is joined by SH20 at Waterview is not formally part of the WRR, in practice it is often used to fulfil the same strategic alternative route function when major incidents occur on the Northern Motorway (SH1).



one of the strategic crossings along with the SH18 Upper Harbour Bridge, SH16 Causeway, SH20 Manukau Harbour crossing and SH1 at Mt Wellington.

Based on this geography, the national strategic role and the first decade strategic modal networks defined by Auckland Transport's Future Connect, the structure and function of the motorway system is summarised in Figure 1.

The motorway system overall services a daily traffic demand of around 12.5 million vehicle-kilometres across the region on a typical weekday (equating to around 1.3 million person-trips per day). Peak weekday traffic demands on the motorway system significantly exceed its capacity, leading to extensive daily congestion.

Based on available data sources the ASM has derived a graph which relates the level of daily motorway demand (in terms of the number of vehicle-kilometres travelled on the motorway network) to the level of customer delay hours per day due to congestion on the motorway mainline, across the entire motorway network (in terms of journey delays over and above free flow, see Figure 2). This graph essentially depicts the daily supply curve of the motorway for general traffic movement – representing overall network capacity. At demand levels below 10 million vehicle-km per day no significant delays occur anywhere on the network at any time of day. The network reaches a capacity of around 10-11 million vehicle-km per day. As daily demand rises beyond 11 million vehicle-km per day, daily congestion rises exponentially. Typical motorway network delays ranged between 20,000 and 50,000 person-hours on weekdays in 2019.

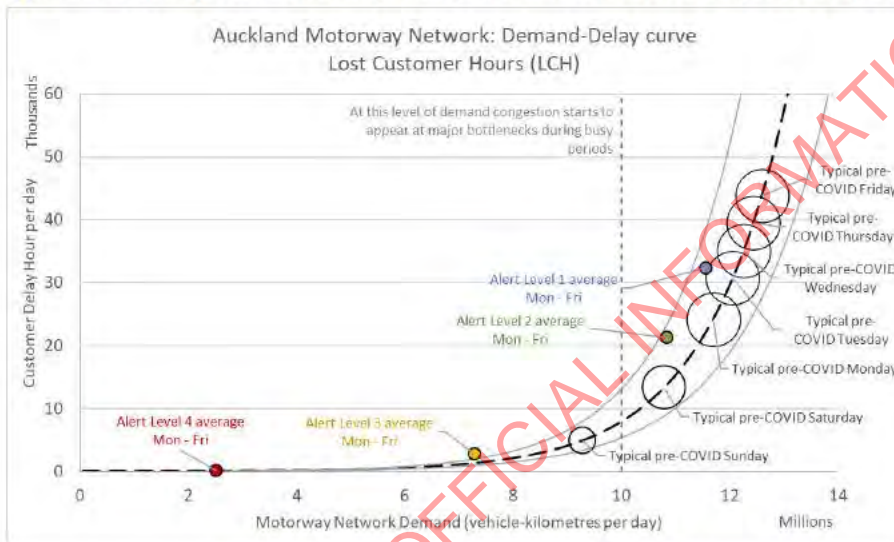

Figure 2 – Motorway network daily Demand-Delay curve

In 2019 a total of around 252,000 person-trips would use the AHB on a typical working day (across all modes in both directions), see Figure 3.

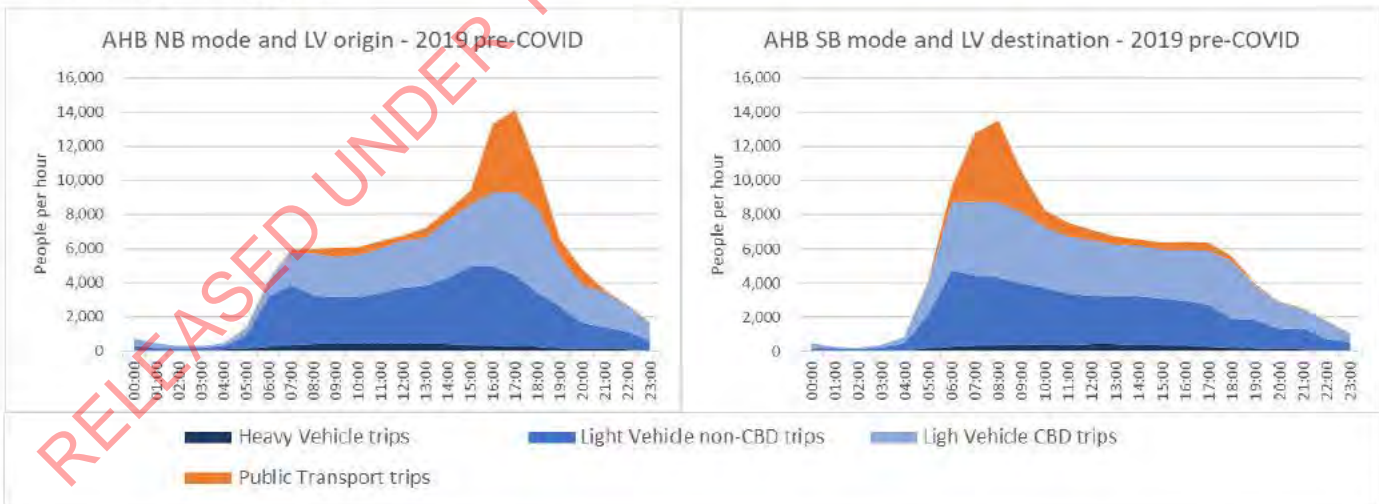

Figure 3 – Breakdown of person-trips using the AHB in 2019

The typical distribution of congestion around the motorway network in the peak periods is illustrated in Figure 4.

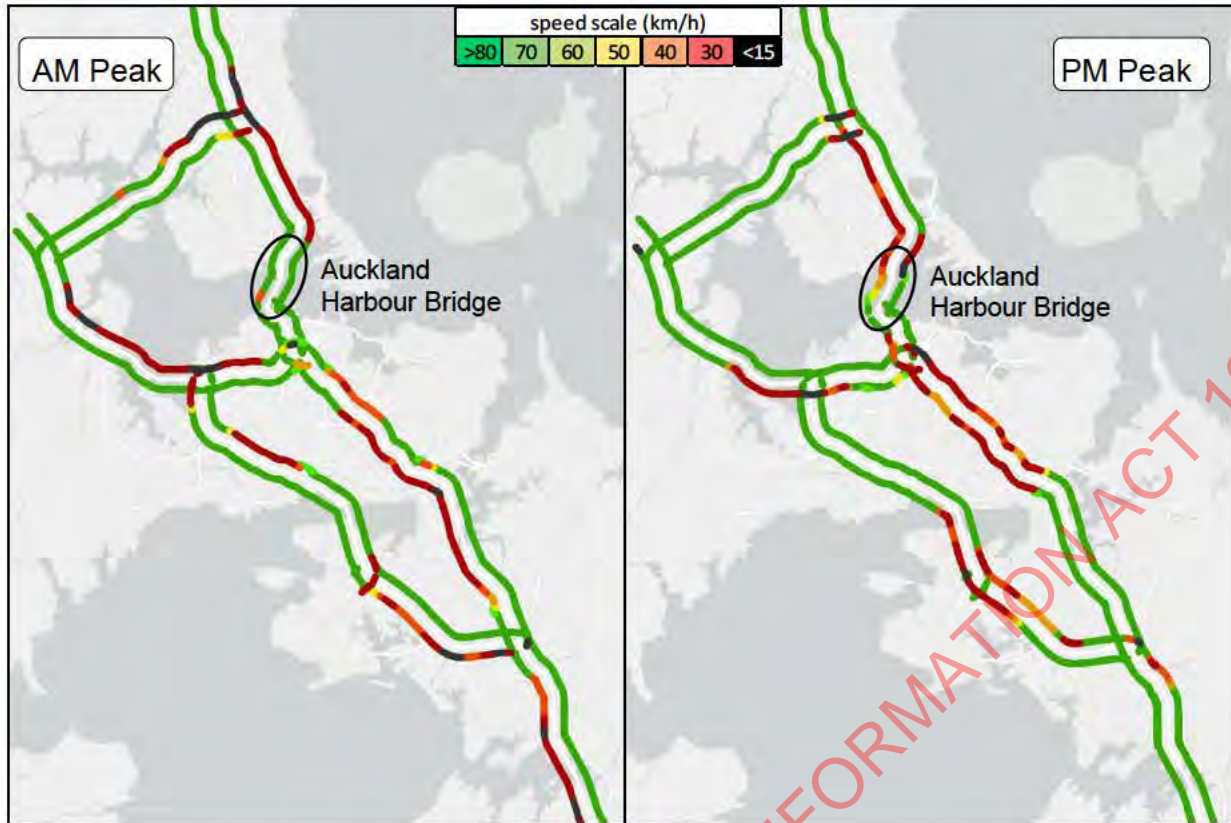

Figure 4 – Typical distribution of congestion across the motorway network in AM and PM peaks in 2019

## 2.2 AHB Current Operation – Traffic Demand and Capacity

Before COVID-19 the AHB carried daily traffic volumes of between 180,000 and 190,000 vehicles on typical weekdays and between 140,000 and 160,000 at weekends. Before the August 2021 COVID Alert Level 4 lockdown demand had returned to around 98% of pre-COVID levels. Vehicle trips across the bridge are more or less evenly split between those to / from the CBD and those to / from SH16 to the west and SH1 to the south.

The eight total lanes of the AHB are arranged in one of three configurations using a Moveable Lane barrier System (MLBS) to accommodate different traffic demand patterns in order to facilitate the bridge’s role as a critical traffic outlet. Figure 5 summarises the different lane configurations and associated capacities.

		Western clip-on			Main truss				Eastern clip-on				
		Northbound			NB	Reversible	SB	Southbound					
AM	Direction	3 lanes	↑	↑	↑	↓	↓	↓	↓	↓	5 lanes	AM	
	Lane capacity (veh/hr) (Max Sustainable Flow-Rate)	5,200	1,800	1,800	1,600	1,800	1,800	1,800	1,800	1,800	9,000		
Inter peak	Direction	4 lanes	↑	↑	↑	↑	↓	↓	↓	↓	4 lanes	Inter peak	
	Lane capacity (veh/hr) (Max Sustainable Flow-Rate)	7,200	1,800	1,800	1,800	1,800	1,800	1,800	1,800	1,800	7,200		
PM	Direction	5 lanes	↑	↑	↑	↑	↑	↓	↓	↓	3 lanes	PM	
	Lane capacity (veh/hr) (Max Sustainable Flow-Rate)	9,000	1,800	1,800	1,800	1,800	1,800	1,600	1,800	1,800	5,200		

Figure 5 – AHB lane configurations and capacities

Note that individual lane capacities vary in some configurations: in a 3-lane configuration the single, narrow, lane on the main truss, captured as a bull run between the bridge structure and the MLB string provides around 12% lower capacity than the other lanes.

There is a second MLB string in St Mary's Bay which varies the lane configuration on approach to the bridge in the northbound direction to match the lane configuration on the bridge. In the PM peak this facilitates the opening of the second (right hand) on ramp at Fanshawe Street which feeds its own lane through St Mary's Bay.

Figure 6 and Figure 7 illustrate typical 2019 pre-COVID profiles of flows arriving at the bridge and the lane capacity available on the bridge over the day, by direction for weekdays. These flows reach the capacity of the bridge in the counter-peak direction (3 lanes) during the peak periods, indicated by the small red sections on the graphs in Figure 6 and Figure 7. In the peak direction at these times (5 lanes) there are upstream capacity constraints where congestion forms - providing a measure of protection against the bridge itself reaching capacity. As a consequence, the flows shown in the graphs do not fully reflect demand at these times, but rather the rate at which traffic can reach the bridge itself (referred to as "arrival flows"). Figure 6 and Figure 7 include lane diagrams of the approaches to the bridge in the peak (5 lane) configurations illustrating the observed flow relative to capacity at these approach constraint locations. Volume-to-Capacity (V/C) ratios in excess of 0.95 are essentially at capacity since capacity in practice is not a fixed value and flows over this level cannot be sustained for long before flow breaks down and congestion starts to form<sup>2</sup>.

In the southbound direction the 5-lane bridge configuration in the AM peak is fed by four lanes upstream – three from downstream of Esmonde Road, plus a lane gain at Onewa Road on ramp. The Esmonde on-ramp merge is one of the primary critical bottlenecks on the motorway network, and along with the 5-lane AM peak configuration on the bridge performs an important strategic function: it ensures no delays to AM peak PT services on the Rapid Transit Network that use general traffic lanes from Onewa Rd to Fanshawe Street. The 4-lane capacity at the Onewa lane gain (immediately prior to the addition of the AM fifth lane on the right-hand side) exceeds the 4-lane capacity of the bridge itself, due to the bridge approach gradient and high lane changing associated with traffic joining at Onewa Road. As a consequence, the AM peak arrival flows at the bridge exceed the capacity of a 4-lane bridge configuration.

In the northbound direction the 5-lane capacity of the bridge exceeds the 5-lane capacity of St Mary's Bay due to the significant curvature and lane changing of the St Mary's Bay section. However, traffic entering from Curran Street merges into the segregated 2-lane section leading up to the western clip-on of the bridge. The additional input of demand from this on-ramp routinely leads to the 2-lane clip-on section reaching capacity during the PM peak - causing localised flow breakdown and congestion while the 3 lanes on the main truss have some capacity remaining. This localised flow breakdown creates minor delays to peak PT services on the Rapid Transit Network that use general traffic lanes on approach to the bridge. Note that since the start of construction of the Northern Corridor Improvements (NCI), capacity constraints associated with the long-term traffic management at this work zone cause extensive queuing on the northern motorway northbound in the PM peak. This often extends back to the bridge and may be limiting the peak flows it achieves and resulting in more extensive congestion through St Mary's Bay. This is expected to reduce once NCI construction completes.

Figure 6 and Figure 7 also illustrate how many vehicles using the bridge use city exits (southbound) and how many enter from the city (northbound), compared to how many vehicles come from or continue onto the southern and northwestern motorways. Vehicle flows are more or less evenly split both in the peak and over the whole day between those to/from the city and those to/from other parts of the region.

At weekends when the bridge remains in a 4-northbound / 4-southbound configuration from Friday evening to Monday morning, the bridge itself forms the capacity constraint on the SH1 corridor. Demands peak around 6,000 vehicles per hour and are roughly sustained between about 11am and 4pm – meaning there is around half a lane of spare capacity in each direction during this time.

<sup>2</sup> Volume-to-capacity ratios more than 1.0 cannot occur in practice. In this situation observed volume is the actual capacity achieved on that day (with the resulting V/C at, or very close to, 1.0). Excess arrival demand then queues upstream of the constraint, waiting to be discharged at the capacity rate – in other words a bottleneck.

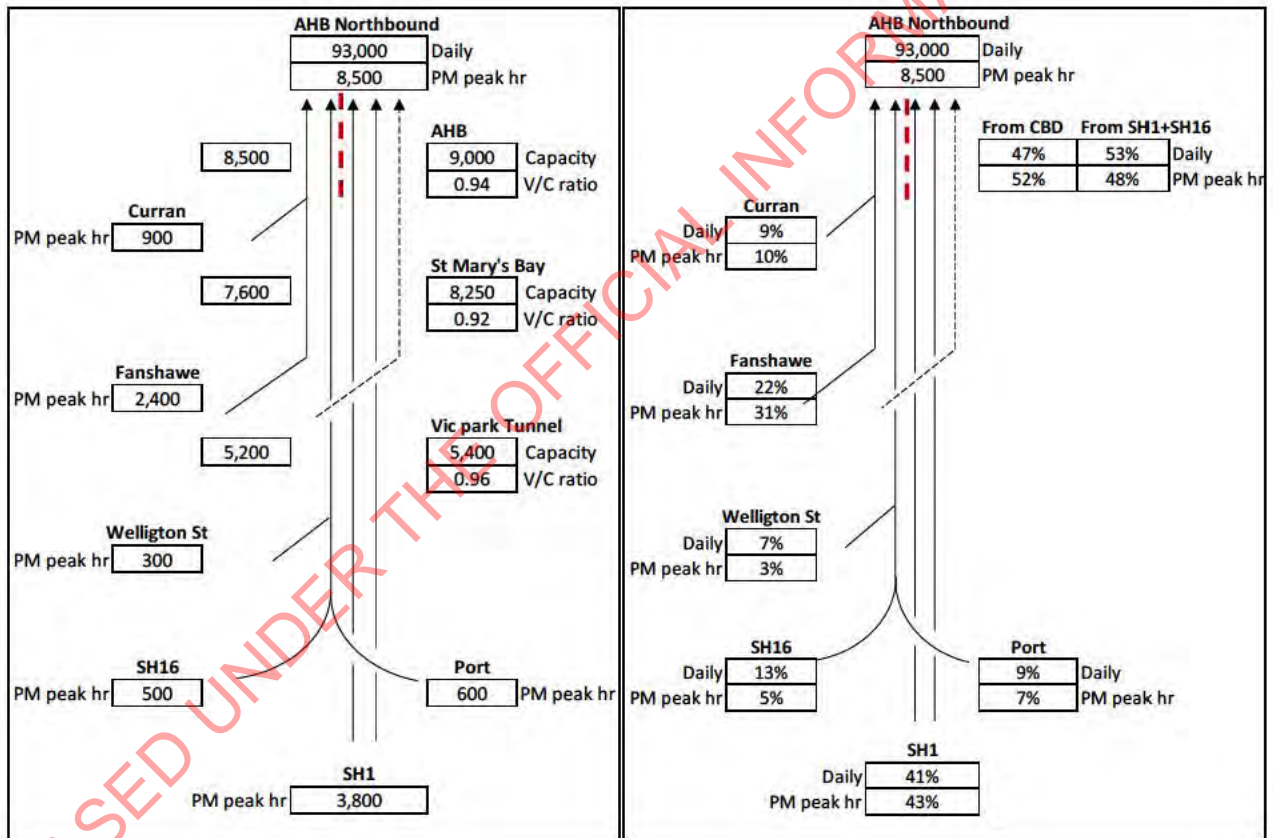
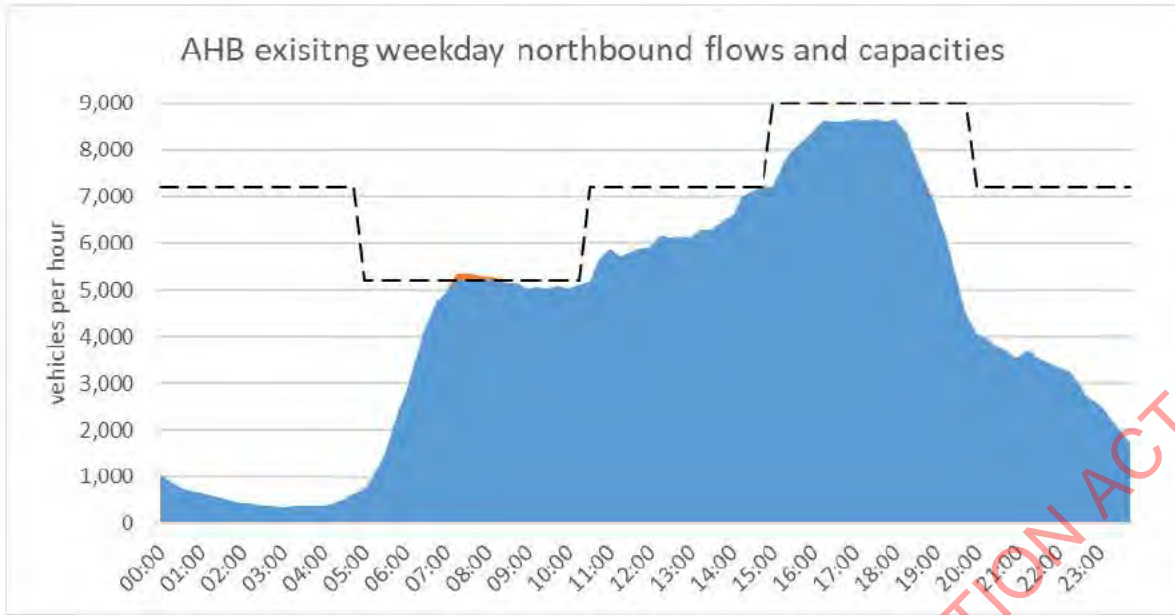

Figure 6 – Summary of typical weekday northbound

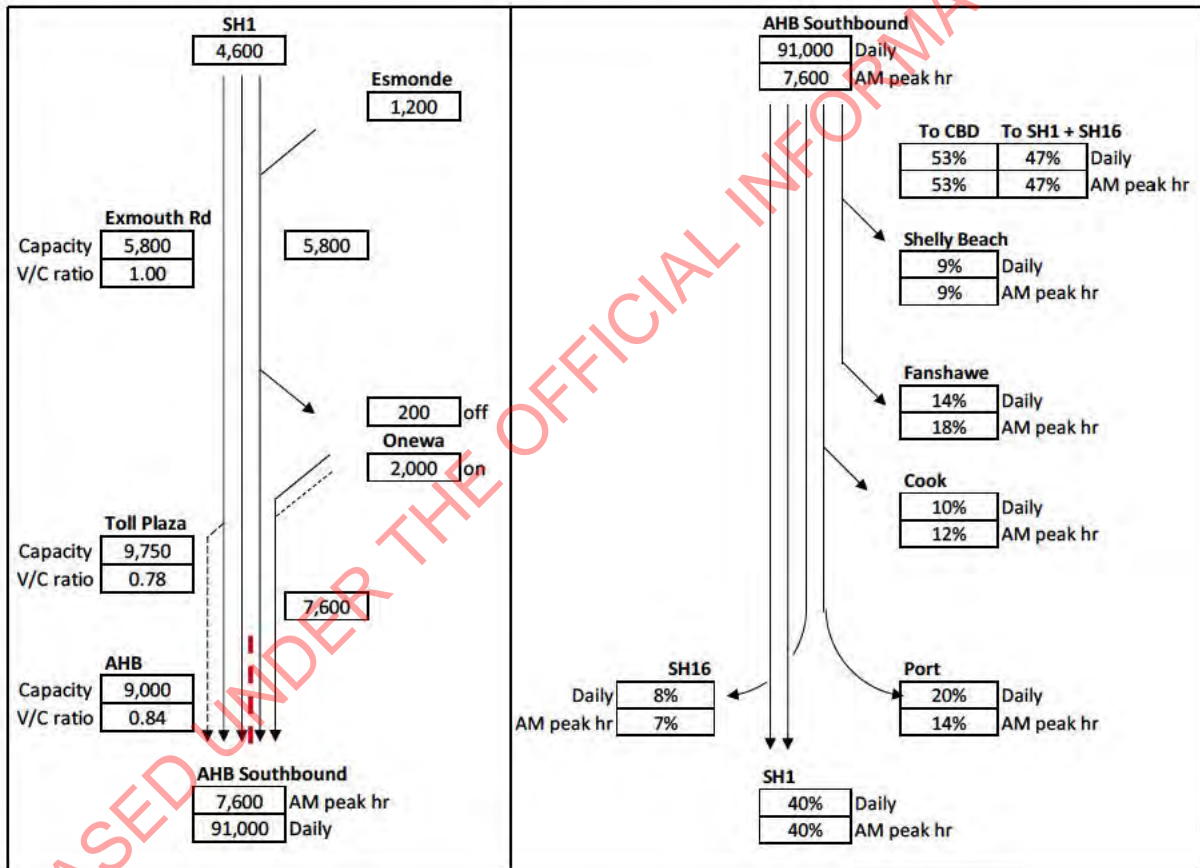
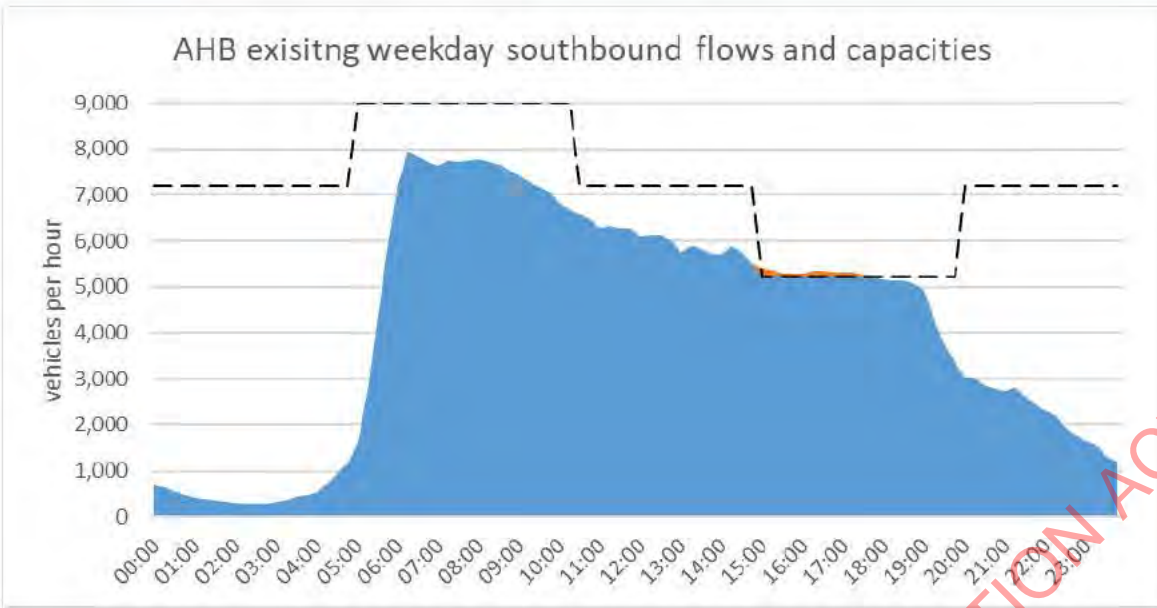

Figure 7 - Summary of typical weekday southbound

### 2.3 COVID-19 and demand changes expected in the coming years

Annual Average Daily Traffic (AADT) volumes over the AHB have been static since 2017, despite continued strong population growth in this period. The corridor constraints associated with the long-term Northern Corridor Improvements (NCI) worksite further along the northern motorway may be contributing to this through increasing congestion on the corridor, constraining PM peak flow on the AHB. During the same period, patronage on the Northern Busway has grown strongly (pre-COVID). Traffic volumes over Upper Harbour Bridge on the SH18 alternative route have continued to grow indicating some displacement (see Figure 8) as overall cross-harbour trip demands grew. Note that, coinciding with the AHB AADT levelling off, the Waterview Tunnel opened in 2017, making the SH18 / SH16 / SH20 alternative route more attractive for some journeys.

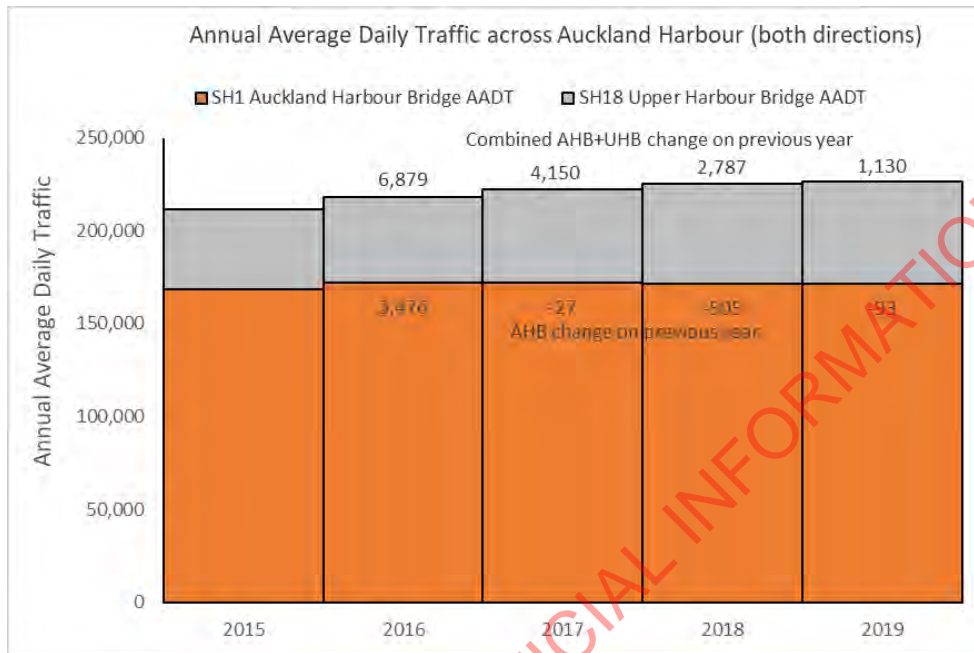

Figure 8 – Recent trends in Annual Average Daily Traffic across AHB and the Upper Harbour bridge (SH18)

The net impact of COVID-19 related behaviour change since the end of 2019 can be estimated roughly from vehicle and PT trip numbers across the AHB during the period March 2021 up to the start of the most recent Alert Level 4 lockdown in August 2021. These are shown in Figure 9 below and indicate a 4% drop in daily trips across the AHB to 243,000 compared to 2019.

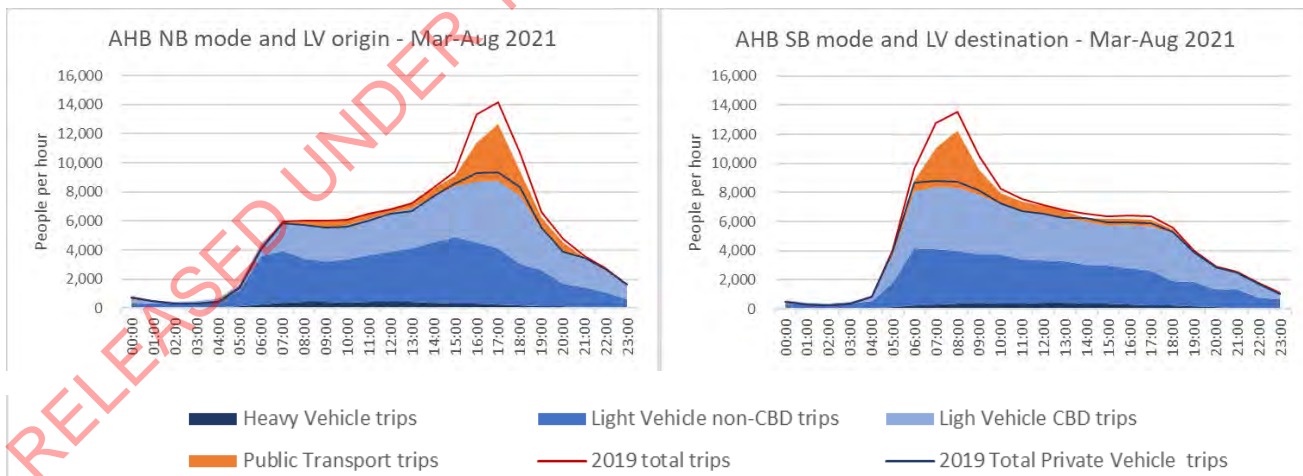

Figure 9 – COVID-19 impact on trips over the AHB March to August 2021

The 4% reduction in person-trips, which mainly occur in the peaks, can be seen as a rough estimate of the persistent increase in Working From Home since 2019.

Over the expected life of a cycle facility on the bridge<sup>3</sup> there are a number of factors that will influence both how the overall traffic demand for the bridge and the profile of traffic arriving at the foot of the bridge over the day is likely to change:

- Population growth over the expected lifespan of the options.
- Changes to the capacity of the Northern Busway over the expected lifespan of the options.
- Continuing impacts of COVID-19 over the expected lifespan of the options (including Traffic Light setting, the emergence of new variants, ongoing reluctance to use public transport).
- Persistence of increased Working From Home (WFH) beyond COVID-19.
- The likelihood of a congestion charge being implemented during the lifespan of the options, the timing of its introduction and the design of the charging scheme.

Forecasts of capacity on the Northern Busway supplied by AT show no increase in current capacity until 2028 and then no further increase until 2038 (see Figure 10). Neither of these increases appears sufficient to accommodate the forecast increases in PT demand over the same period based on recent modelling carried out for AT by the Auckland Forecasting Centre (see Figure 11). This leaves a question mark over the associated forecasts of no further increases in AHB traffic demand as the population continues to grow.



Figure 10 – Forecast increases in AM peak PT capacity across the AHB (source- Auckland Transport)

<sup>3</sup> It is assumed that the anticipated lifespan would be until the Additional Waitemata Harbour Crossing (AWHC) is complete, which is unclear at this stage but not anticipated until the mid-2030s.

Forecasted AM Peak Period Public Transport and Private Vehicles  
Travel Demand across the Auckland Harbour Bridge

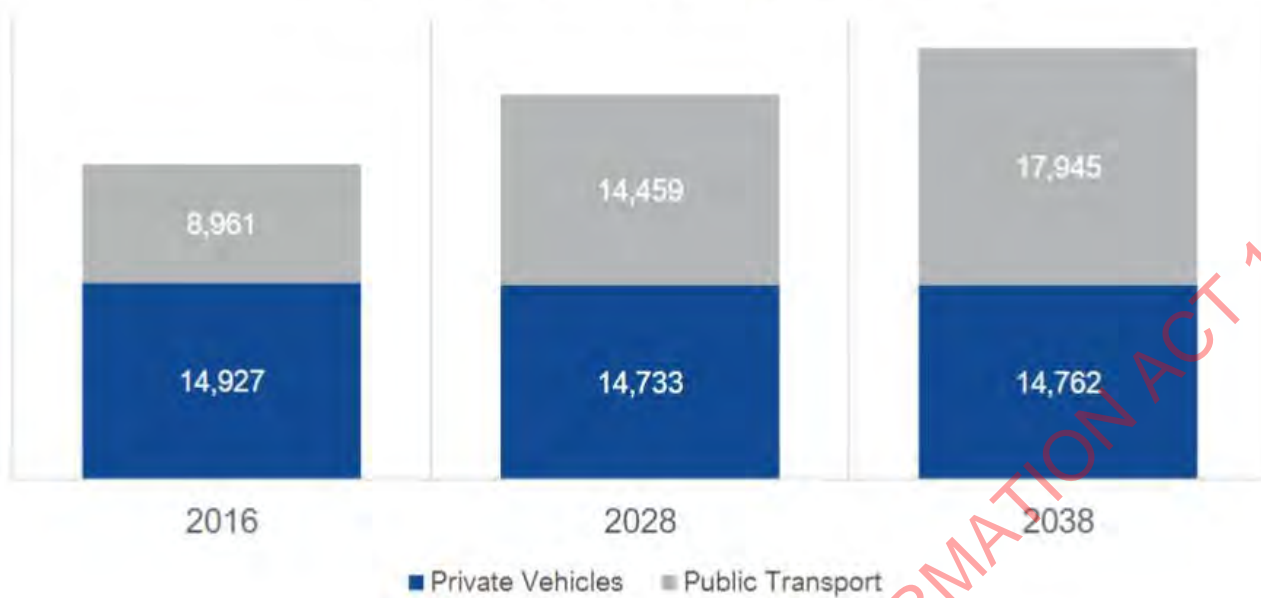

Figure 11 – Forecast increases in AM peak PT and traffic demand on the AHB (source- Auckland Transport)

The most recent modelling on the impact of a potential congestion charge on AHB traffic demands indicates a 15% to 18% reduction in peak flows across the whole network after the full introduction of the charge, with some corresponding increase in traffic in the interpeak period of around 6%-7% (info supplied by Auckland Transport from the latest model update prepared for the TCG Steering group – model refresh 27\_1\_2022). However, the earliest that any form of congestion charge could realistically be implemented is 2025 (although this has not been confirmed - and it could be later with political and technology issues being the main determinants).

The latest MoT Household travel modelling for 2057/58 indicates across all five of their scenarios that population growth is expected to drive increased vehicle trips in Auckland over the coming decades, even accounting for planned PT investment, vehicle fleet electrification and an anticipated significant shift towards increased use of ride-share services (see Figure 12). The MoT's congestion charging scenario shows the lowest growth in traffic, but still indicates a 36% increase in traffic generating trips over 40 years, over and above the 2017/18 level.

Notwithstanding the potential for current or future border restrictions associated with COVID-19 to depress immigration, the current projected regional population growth over the next 10 years includes significant growth around Silverdale, Orewa and Warkworth in the north of the Auckland region.

The implications of this uncertainty around future traffic demand on the AHB for assessing traffic impacts of the proposed active mode options are considered in section 4.



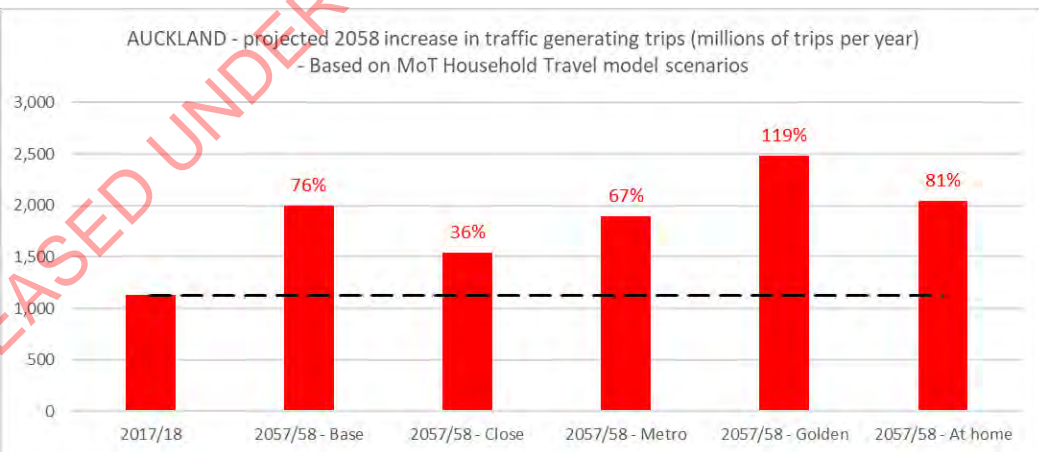
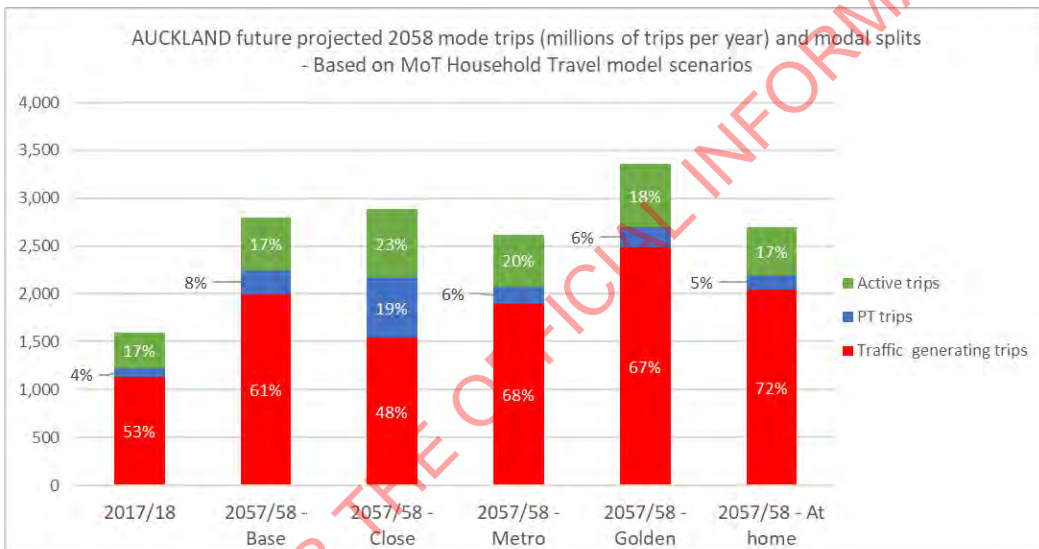
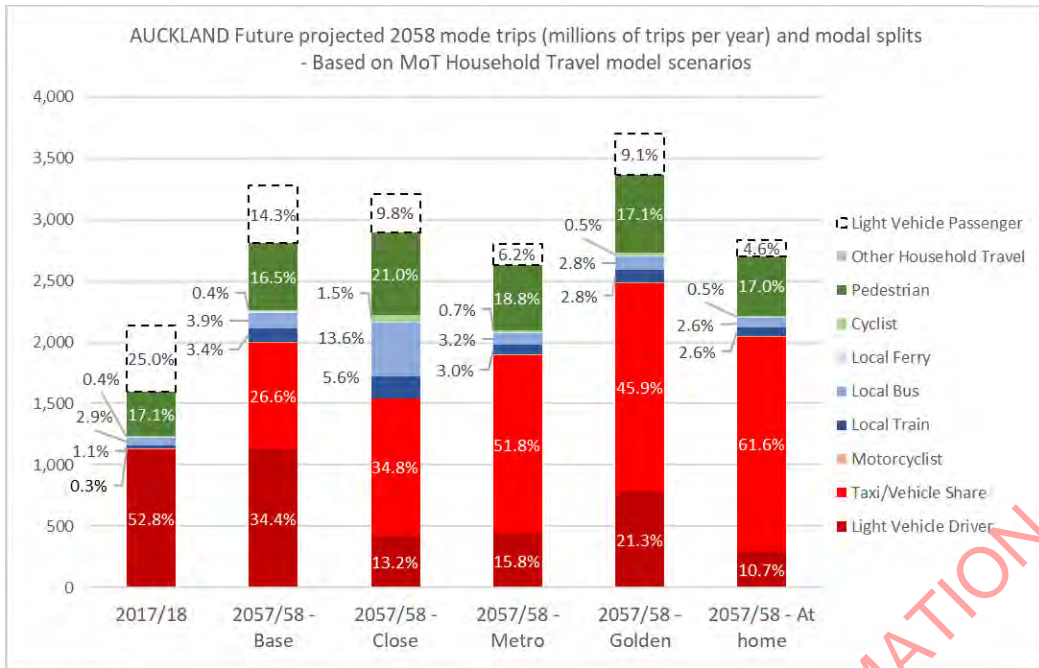

Figure 12 – MoT forecast trip growth for Auckland for the next 40 years (note "close" scenario includes congestion charging)

### 3. PROPOSED OPTIONS TO BE FURTHER ASSESSED

The lack of a connection between the North Shore and the Central City is a critical gap in the regional cycle network with the primary regional cycle route running north-south on the North Shore currently being developed (the Northern Pathway) lacking a direct connection to the regional cycle routes in the Central City and downtown areas.

Two options for the provision for active modes on the Auckland Harbour Bridge (AHB) intended to fill this gap have been selected by Waka Kotahi from the previous assessment of a wider group of options carried out in May-June 2021 for further investigation.

Both options are for a permanent 24/7 active mode facility on the southbound (eastern) clip-on. Both options would join the motorway on the northern side of the bridge after the Onewa Road On ramp and bus shoulder merge downstream of this. Both would leave the motorway at the Shelley Beach off ramp, which would be closed to traffic. The two options are primarily distinguished as follows:

- 1-Lane option. Lane 1 of the southbound clip-on would be reallocated to active modes with general traffic remaining on lane 2 of the southbound clip-on, the main truss and the northbound (western) clip-on (seven lanes in total).
  - The allocation of the remaining lanes would provide four lanes for peak traffic (southbound in the AM and northbound in the PM) with three lanes in the counter peak direction. The lanes would be required to switch in the middle of the day by means of the existing Moveable Lane Barrier System (MLBS) and then revert again in the late evening or overnight prior to 5am the next day.
  - The form of physical segregation between traffic in lane 2 and active modes in Lane 1 is yet to be determined. The use of a TL-4 crash barrier is unlikely due to the additional dead load this would impose on the clip-on structure and/or the difficulty in securing the barrier system to the bridge structure. Light weight barriers, separators and delineators are more likely, which would reduce the useable width for both the active mode facility and the remaining traffic lane. It is possible a permanent reduced speed limit would be applied to traffic using the remaining traffic lane on the clip-on.
- 2-Lane option. Both lanes of the southbound clip-on would be allocated to active modes with general traffic using only the main truss and northbound clip-on (six lanes in total).
  - The allocation of remaining lanes would provide three lanes in each direction all day, with no reversing of lanes using the MLBS. Note that the Barrier Transfer Machine (BTM) would still be required to regularly pass back and forth across the bridge and through St Mary's Bay to ensure the barrier blocks do not remain out of position if struck, to maintain tension on the barrier strings and to ensure all plant and systems that form part of the MLBS remain in good working order.
  - As the bridge structure provides complete separation of active modes from motorway traffic the issues of physical segregation associated with the 1-Lane option would not arise with the option of the main bridge structure. The design and layout of the transition of the active mode facility from running alongside the motorway south of Onewa Road on ramp onto the current left two running lanes will require suitable segregation from adjacent traffic prior to the segregation of lanes on the bridge.

## 4. ASSESSMENT METHODOLOGY

### 4.1 Uncertainty and Constraints

The assessment is subject to considerable uncertainty as the analysis of traffic impacts are very sensitive to small changes in the following two key input variables:

- The traffic demand on the AHB under each of the options.
- The resulting traffic capacity of the AHB and its approaches under each of the options.

The tools and techniques employed for the assessment are intended to aid in understanding the likely outcomes, given the knowledge at the time the assessment was undertaken. They are not a crystal ball. The results of the assessment are presented as ranges of values where possible to avoid inviting an interpretation of unwarranted precision.

The primary constraint on the assessment was the limited time available to complete it (January and February 2022).

### 4.2 Methodology

A methodology was developed based on two key elements to allow for the uncertainties and constraints identified above:

- A risk-based approach that considered credible maximum-minimum ranges for key uncertain inputs.
- Multiple stages of progressively more refined assessment carried out on a reduced number of options at each stage.

The result was a three-tiered methodology, with each tier representing a filter or “gate” that was progressively more demanding for an option to pass through (see Figure 13). This meant more detailed and time-consuming assessments were only applied to the most promising options:

- Tier One Assessment: the previous assessment carried out in May-June 2021.
- Tier Two Assessment: further assessment of the two options selected from the May-June 2021 assessment, based on “typical weekday” 50<sup>th</sup> percentile (P50) traffic demands. If this assessment indicated excessive network traffic impacts for either option, then the assessment for that option was terminated at this point.
- Tier Three Assessment: more detailed assessment of any remaining options with enhancements in two areas:
  - Consideration of day-to-day traffic variability by testing options against 90<sup>th</sup> percentile (P90) demands.
  - Fine-tuning of traffic capacities and arrival flows on approach to the AHB in each direction

It is understood that if one of the active mode options is pursued it would be implemented within 2022, at least three years before any congestion charge, which is assumed to be in 2025 at the earliest. Due to the uncertainty around the trend in AHB traffic demands after this point the assessment only considers the three-year period from 2022 to 2025. On this basis the base traffic demands are assumed to remain at 2019 levels for this period (AHB AADT values have been more or less static from 2017 to 2019).

The likely changes in person trips and traffic demand across the AHB as a result of lane reductions for the active mode facility options were estimated using a bottom-up approach where key values from relevant available data sources were used to “anchor” maximum and minimum demand shift values for each of the options. Appropriate actual AHB traffic volumes under previously experienced demand reduction scenarios (as well as the most recent congestion charging modelling undertaken by Auckland Forecasting Centre) were used as a top-down “sanity check” on the reasonableness of the resulting AHB traffic volume profiles.

The traffic analysis focuses on the following areas:

- Overall magnitude of congestion and delay impacts.
- Distribution of congestion and delay impacts across the motorway network.
- The impact on the reliability of customer journeys.
- The impact on network resilience.

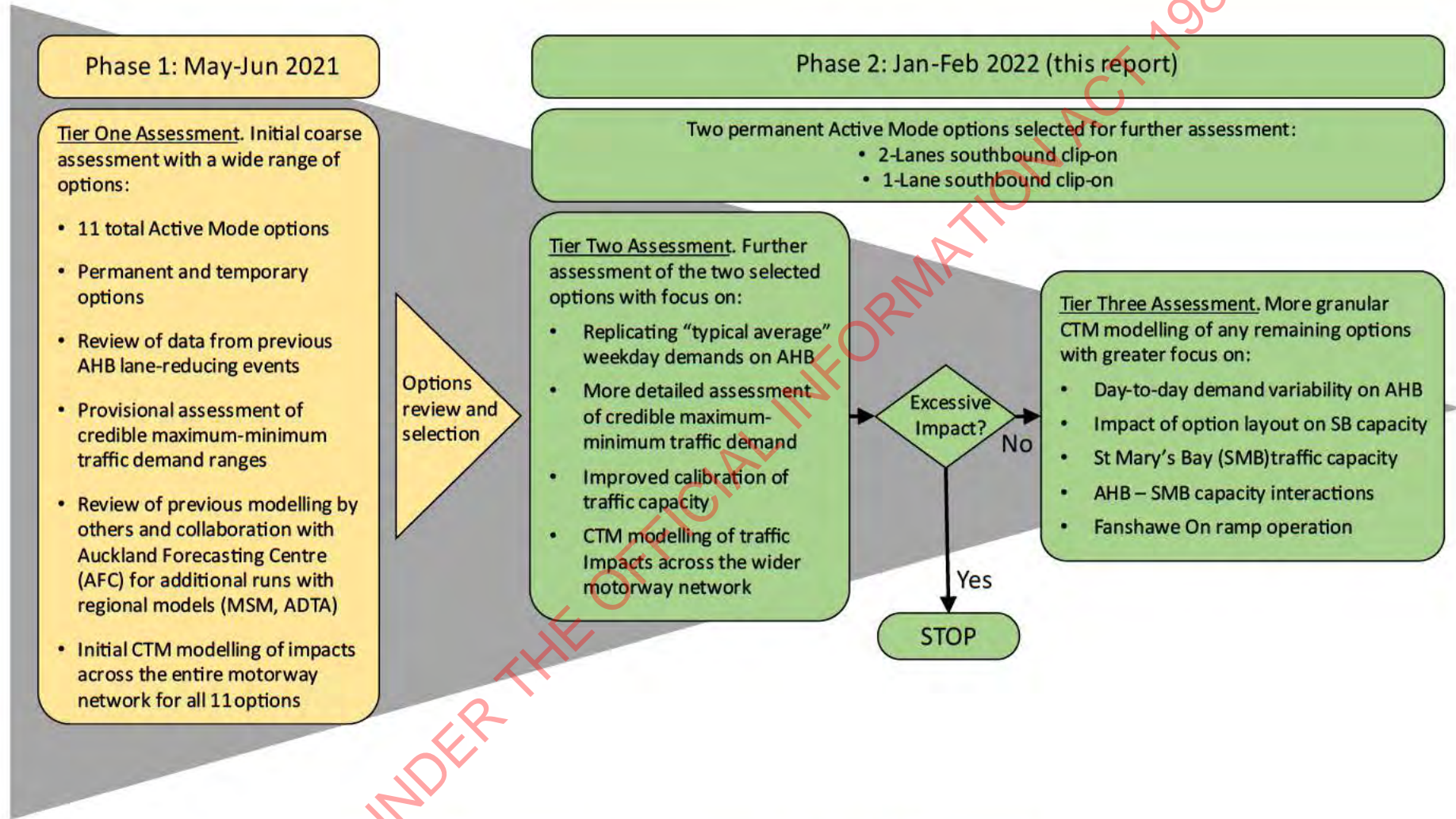

Figure 13 – The progressive, three-tier methodology adopted for the assessments

RELEASED UNDER THE OFFICIAL INFORMATION ACT 1982

A key feature the traffic analysis needed to capture was the interconnectedness of the motorway network and the way that when it carries a heavy traffic load, congestion impacts spread rapidly over large distances across the system like ripples on a pond in a way that can persist between time periods normally analysed in isolation (AM peak, inter peak and PM peak). In other words, a change introduced at one location can cause impacts at other locations and times remote from the original change. To best capture this effect a macroscopic traffic simulation model which covers the entire motorway system, and the entire day, was used.

The Auckland Motorway Network Cell Transmission Model (CTM) uses a mathematical analogy of traffic to fluid flow in a way that can accurately capture the growth and recovery of congestion by time and location across the whole motorway network over a 24-hour period in a single model using 10-second time steps. It has been fully calibrated and validated as a 2018 base model, with a 2019 update (Appendix A explains the reasoning for selection of the CTM over other available modelling tools). Minor adjustments were made to CTM traffic demands to adjust the AHB traffic arrival profile in the model to better match the AHB traffic demands chosen from historical data as the base for the demand assessment (explained in sections 5 and 6).

The assessment considered best-case (maximum demand with minimum capacity) and worst-case (minimum demand with maximum capacity) scenarios for each option.

Note there are several sources of traffic data that measure the level of traffic demand across the AHB on which the impact assessment could draw to establish base traffic demands. The assessment and selection of data sources for the AHB used in this assessment are summarised in Appendix B.

### 4.3 Limitations

The primary limitations of the assessment that should be noted are as follows:

- The CTM is a **simulation** model only. It does not perform **route assignment**. A manual iterative approach was used to reassign trips away from the SH1 to the WRR where a comparison of modelled travel times (on-ramp to off-ramp) indicated substantial travel time savings.
- The CTM does not include arterial or local roads. However, it does accurately simulate the SCATS Ramp Metering System (SRMS) through incorporating algorithms that replicate the coordinated and traffic responsive functions of the system. Consequently, on-ramp queue lengths and delay times are captured and the relative change in these results provide an approximate way to infer whether impacts on the arterial network are better / worse between options.
- Based on the input uncertainties discussed above a Quantitative Risk Assessment approach (using @RISK software or similar) was initially considered, but subsequently rejected for 2 reasons:
  - It was felt insufficient data was available to confidently define distributions for input variables – which could lead to results being interpreted with a false sense of precision.
  - The CTM simulation tool is complex and not set up for Monte Carlo analysis with 000's of iterations. There was insufficient time to enhance the CTM software with this capability for this assessment.

## 5. TIER TWO ASSESSMENT

### 5.1 Traffic Demands

#### 5.1.1 Deriving Demands for the Assessment

The AHB traffic demands used in the assessment were derived in four steps as indicated in Figure 14. The mode shift demand reduction steps include mode shift to active modes (on the new AHB facility); mode shift to public transport; and working from home.

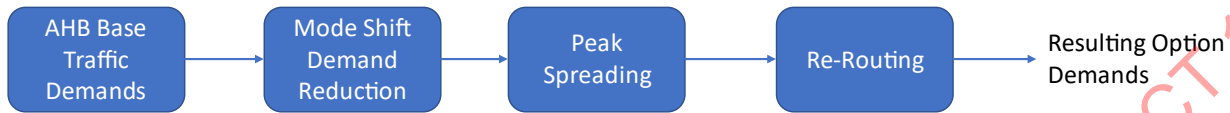

Figure 14 – Four steps involved in deriving traffic demands for the assessment

#### 5.1.2 Base Traffic Demands

Considering the varied and in some cases inconsistent forecasts for vehicle demands on the AHB in coming years and decades reviewed in section 2.3 there remains a lot of uncertainty as to whether they will increase further from 2019 levels and if so, by how much. However, given daily AHB traffic had returned to pre-COVID levels before the August 2021 lockdown, and no congestion charge is expected before 2025 at the earliest, it seems reasonable for the purposes of this assessment to assume that traffic demands on the AHB remain at roughly 2019 levels over at least the next 3 years.

The current 4% reduction in daily person-trips across the AHB compared to 2019 levels indicated in Figure 9, which mainly occur in the peaks, is taken to approximately represent a persistent increase in WFH since 2019, which was “baked into” the base demand for the assessment as follows:

- Daily vehicle demands were assumed to be as per the 2019 50<sup>th</sup> percentile (P50), given demands were trending upwards between March and August 2021, with peak flows returning to within 2% of 2019 levels by August 2021 (and daily demands exceeding 2019 levels).
- PT patronage was assumed to be at March 2021 levels – this provided some spare PT capacity to accommodate mode shift from private vehicles within a hard constraint on increasing PT capacity that was assumed for the next 3 years based on Figure 10 in section 2.3.

The base AHB vehicle demands profiles for the tier-two assessment were established as follows from traffic count data for the whole of 2019:

- Establish total daily traffic demands in each direction. Weekends, public holidays, and the Xmas / New year period were excluded and the P50 of the remaining (working) days was taken as the base daily demand to represent a “typical” weekday.
- Determine distribution of traffic demands across the day. The average percentage of daily demand recorded in each hour of the day across the remaining (working) days was taken as the percentage of daily demand arriving at the base of the AHB in each hour.
- Generate base traffic arrival profiles. The percentages for each hour were applied to the typical daily demand for each direction to generate the base northbound and southbound traffic arrival profiles (see Figure 15)

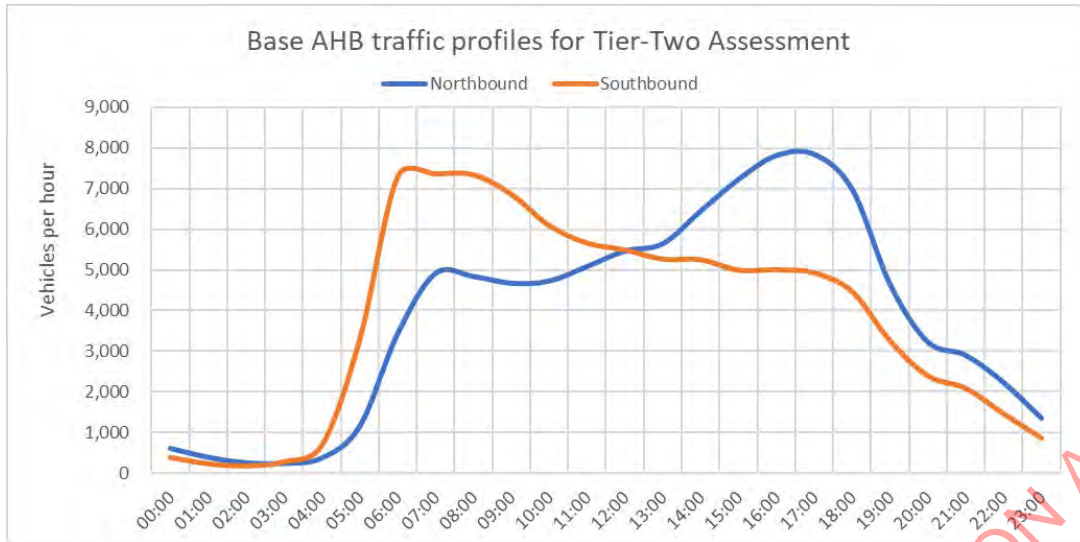

Figure 15 – Base AHB traffic profiles used for Tier-Two Assessment

The traffic demands in the CTM 2019 base model represent a heavy traffic day on the network (rather than the P50). Therefore, to provide corresponding total daily demands for the AHB in the model demands were globally factored to bring the AHB demands into line with 2019 observed P50 in each direction (see Figure 16).

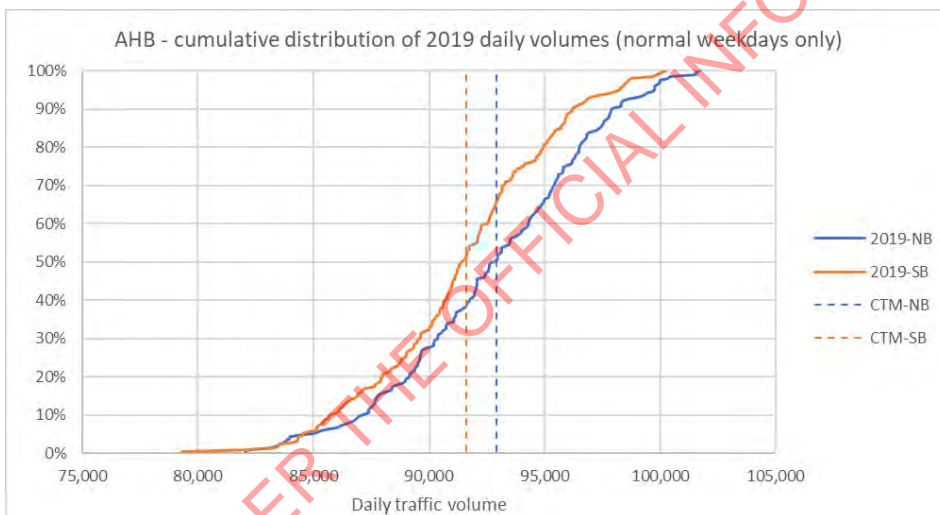

Figure 16 – Factored CTM daily demands for the AHB compared to the distribution of 2019 observed daily volumes.

### 5.1.3 Mode shift to active modes

No significant change was made from the level of active mode uptake on the new facility assumed in the tier-one assessment. The data used as the basis for the tier one assessment was reviewed again and supplemented with data from additional sources (see Figure 17)

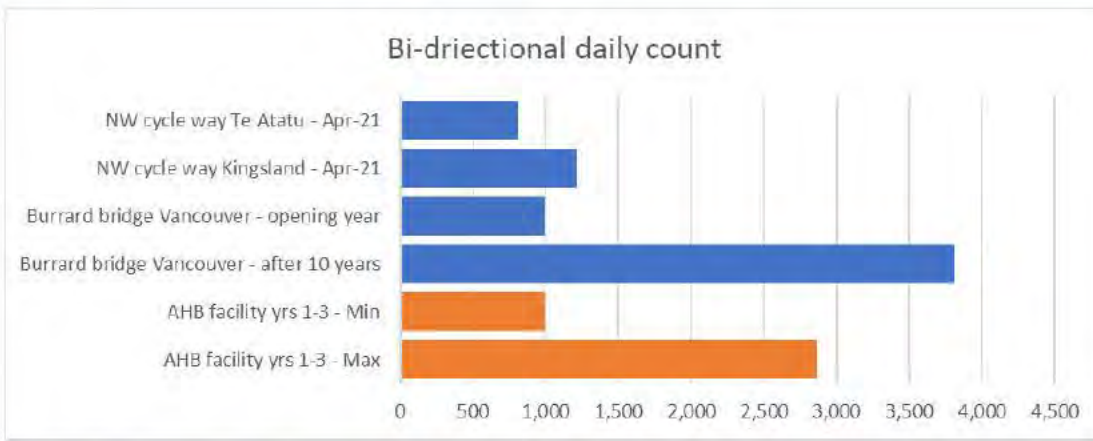

Figure 17 – Range of daily active mode trips assumed on the proposed AHB facility and data from comparable facilities

For the tier-two assessment the following levels of pedestrian and cyclist demand were adopted:

- Low – 1,000 trips per day (both directions, evenly split)
- High – 2,860 trips per day (both directions, evenly split)

Note that not all active mode use of the new facility will remove traffic demand from the bridge. Some of these trips will shift from PT and some may be newly generated trips (many of these at weekends for recreational reasons). For the purposes of this assessment, it has been assumed that all active mode trips using the bridge will be to/from locations in or close to the Central City. As a result, the proportion of active mode trips shifting from PT (as opposed to private vehicle) has been assumed to be 30% on weekdays during peaks - based on AT patronage data (assuming all PT trips are similarly to/from locations in or close to the Central City) and the proportions of vehicles using the bridge headed to/from the Central City.

#### 5.1.4 Mode shift to PT

The hourly patronage data for PT services over the AHB for March 2019 and March 2021 that was used for the tier one assessment was re-examined to help establish (see Figure 18) assumptions for mode shift to PT for the tier two assessment.

The primary change to the tier-one assessment was to review hourly patronage data to determine an “anchor value” for what the maximum shift to PT might be. As the northern busway was operating at capacity in the AM peak in 2019, the peak hour patronage in March 2019 was taken as the maximum achievable hourly value for the assessment, given the indication of no additional PT capacity being available on the AHB until 2028 in Figure 10.

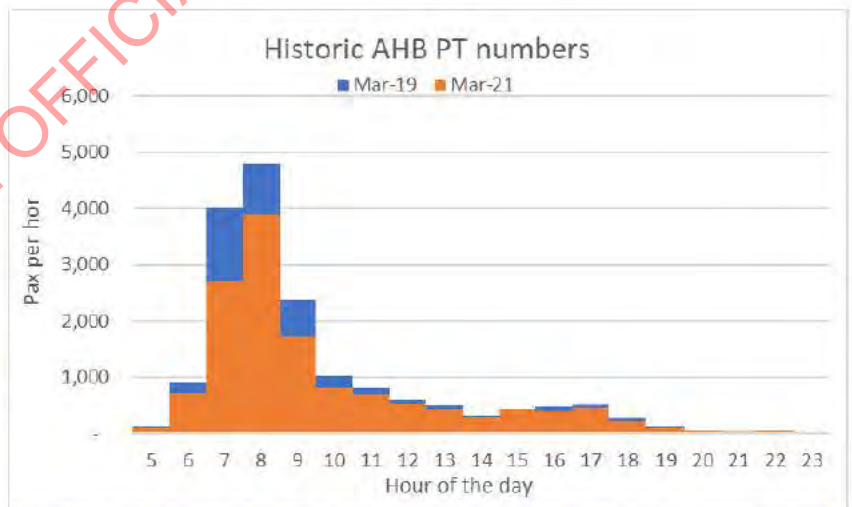

Figure 18 -Comparison of hourly PT patronage on the AHB between March 2019 and March 2021



A return to March 2019 patronage across the whole day was initially taken as the maximum mode shift to PT across the day (indicated by the blue sections of the bars in Figure 18). However initial CTM testing of the 2-Lane option indicated extremely high traffic impacts leading to a revision of this. Maximum mode shift to PT was increased to the level indicated by the grey bars in Figure 19. This meant both peak hours achieve the maximum hourly patronage from the March 2019 data (which aligns with the highest service frequency for many of the bus services that cross the AHB), along with the trailing hour of the AM peak (9-10am) increasing to the level seen in the 7-8am hour in the March 2019 data compared to the March 2021 data (with the remaining hours returning to March 2019 levels).

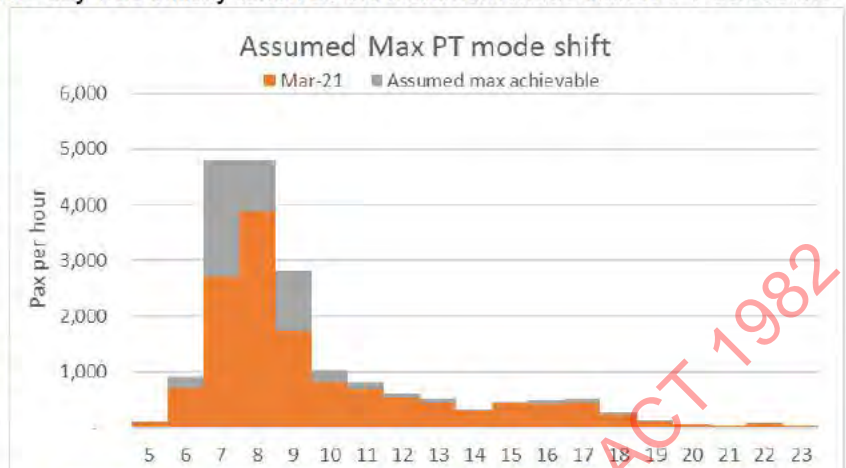

Figure 19 – Assumed maximum mode shift to PT (grey) on top of PT patronage on the AHB in March 2021

Ultimately a return to March 2019 levels across the day was anchored as the PT mode shift for the MAXIMUM<sup>4</sup> demand scenario for the 2-Lane active mode option, with the higher level indicated in Figure 19 being taken for the MINIMUM demand scenario for the 2-Lane option. This target is very optimistic; however, it was still used to test how sensitive the results were to a mode shift to PT that would result in patronage across the AHB being somewhat higher in the peak than in 2019.

The MINIMUM demand scenario values for the 1-Lane option were set at just over half the increase assumed for the 2-Lane MAXIMUM, with the 1-Lane MAXIMUM being half of this. Overall, the range of daily trips in both directions assumed to shift to PT for each option were:

- 2-Lane option MINIMUM traffic demand – 10,000 trips shift to PT
- 2-Lane option MAXIMUM traffic demand – 7,500 trips shift to PT
- 1-Lane option MINIMUM traffic demand – 4,000 trips shift to PT
- 1-Lane option MAXIMUM traffic demand – 2,000 trips shift to PT

The hourly breakdown by direction can be found in Appendix C.

### 5.1.5 Working from Home

Since the base PT patronage was taken as the level in March 2021 then an estimated level of Working From Home (WFH) equal to the blue bars in Figure 18 was effectively “baked into” the base trip demands as indicated in Figure 9, creating the spare PT capacity used up by the PT mode shift assumptions above. Therefore, any vehicle trips removed from the base traffic demands would represent ADDITIONAL working from home. The current level of WFH was initially assumed to continue in all scenarios (i.e., no removal of vehicle trips from the base demands). This “baked in” level of WFH equated to around 7,400 trips per day (both directions) with a maximum of 1,300 per hour in the peak direction (around 10% of March 2019 peak hour person-trips on the AHB).

However early testing of the 2-Lane option indicated very high traffic impacts, so this assumption was revised for the MINIMUM traffic demand scenario to provide an additional:

- 12% of Central City trips switching to WFH – 6-10am southbound, 4-7pm northbound
- 5% of non-Central City trips - 6-10am southbound, 4-7pm northbound

The hourly breakdown by direction can be found in Appendix C.

### 5.1.6 Peak Spreading

Peak spreading was applied by smoothing out demands between specified times in the AM and PM periods – the total demand across the defined period was averaged and this average value used in each hour of the period. In all cases peak spreading was applied southbound between 6am and 11am in the morning and northbound between 2pm and 7pm in the afternoon.

<sup>4</sup> Note – MAXIMUM is used to refer to the maximum remaining traffic demand on the AHB, associated with the minimum shift to modes, routes.

### 5.1.7 Trip Re-routing and Re-timing

The potential re-routing options for private vehicle trips across the bridge are limited to the use of SH18 by way of the Upper Harbour Bridge, SH16 and depending on where the trip is to/from SH20. SH16 ramps at CMJ provide alternative access to/from the CBD; links to SH1 (southern) via CMJ and SH20 via Waterview Tunnel provide motorway connectivity for trips to/from further south.

In the tier-one assessment the re-routing via the SH18 Upper Harbour Bridge predicted by both the MSM and NCI SATURN models for tests of a 1-Lane or 2-Lane reduction on the AHB was reviewed (see Table 1). The predicted re-routing was inconsistent between these models, and in addition neither reflected the capacity constraints nor resulting congestion on SH16 accurately which would significantly affect the attractiveness of the alternate routes.

Table 1 – MSM and SATURN re-routing indicated via Upper Harbour Bridge (SH18)

	1-lane options		2-lane options
(vehicles/hr)	MSM	NCI SATURN	MSM
<b>AM peak (SB)</b>	<100	200	250-300
<b>PM peak (NB)</b>	100-200	800	600-650

For the tier-two assessment no re-routing was assumed for initial CTM runs. A manual iterative approach was used to reassign trips away from the SH1 to the WRR where comparison of modelled travel times for the following journeys (on-ramp to off-ramp) indicated substantial travel time savings (in each case both journey directions were considered):

- Onehunga/Penrose to Lincoln Rd
- Onehunga/Penrose to Albany
- Manukau to Albany

The level of travel time advantage required on the alternate route to attract traffic was guided by a comparison of relative travel times between Albany and Onehunga / Penrose via SH1 (Constellation ramps to SEART ramps) and via SH18/16/20 (Albany Highway ramps to Neilson Street ramps) from September 2019 TomTom data (see Figure 20).

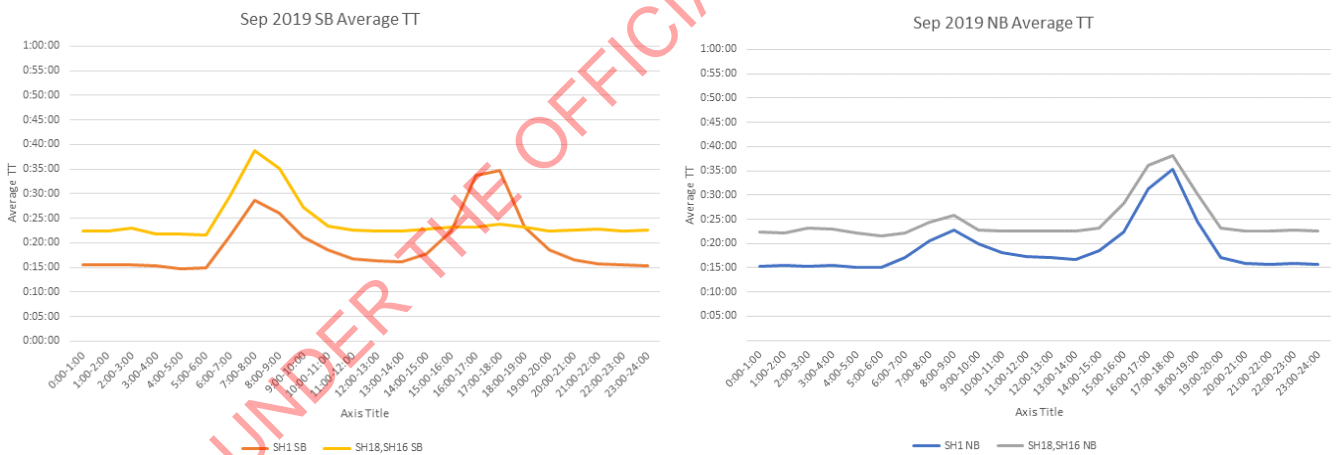

Figure 20 – Observed travel time differences between SH1 and alternate SH18/16/20 route

Based on this the following total number of vehicle-trips was re-routed across the whole day (both directions) for each scenario:

- 1-Lane option – none
- 2-Lane option MINIMUM traffic demand scenario – 3,400 vehicle-trips over 8 hours
- 2-Lane option MAXIMUM traffic demand scenario – 8,000 vehicle-trips over 8 hours

The hourly breakdown by direction can be found in Appendix C.

5.1.8 AHB traffic demand reductions assumed in the assessment

The demand changes for each option were aggregated using an assumed average vehicle occupancy of 1.2 to determine the net reduction in AHB traffic demand by each hour of the day (see Figure 21, Figure 22 and Figure 23). The tables in Appendix C provide the full breakdown by mode and hour with aggregation to net reduced AHB vehicle demands.

Tier 2 Assessment – Summary of Option Demand Scenarios

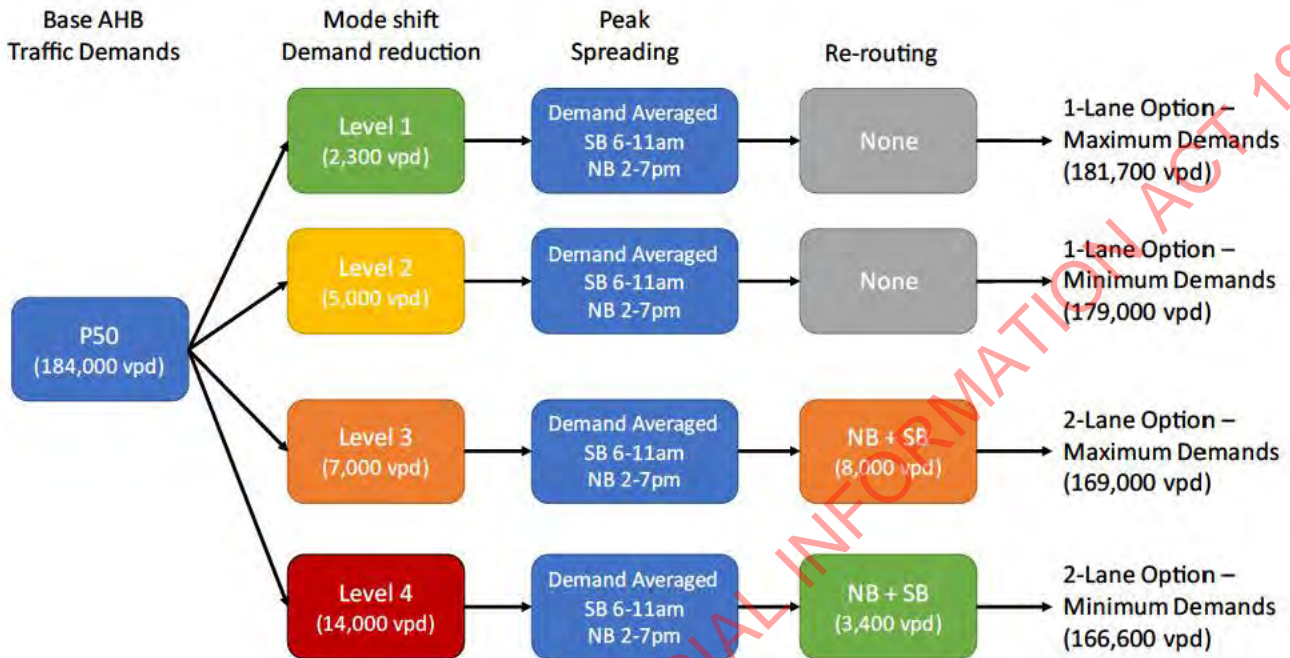

Figure 21 – Summary of demand scenarios used in tier-2 assessment



Figure 22 – AHB southbound – maximum and minimum reductions in traffic demands assumed for each option

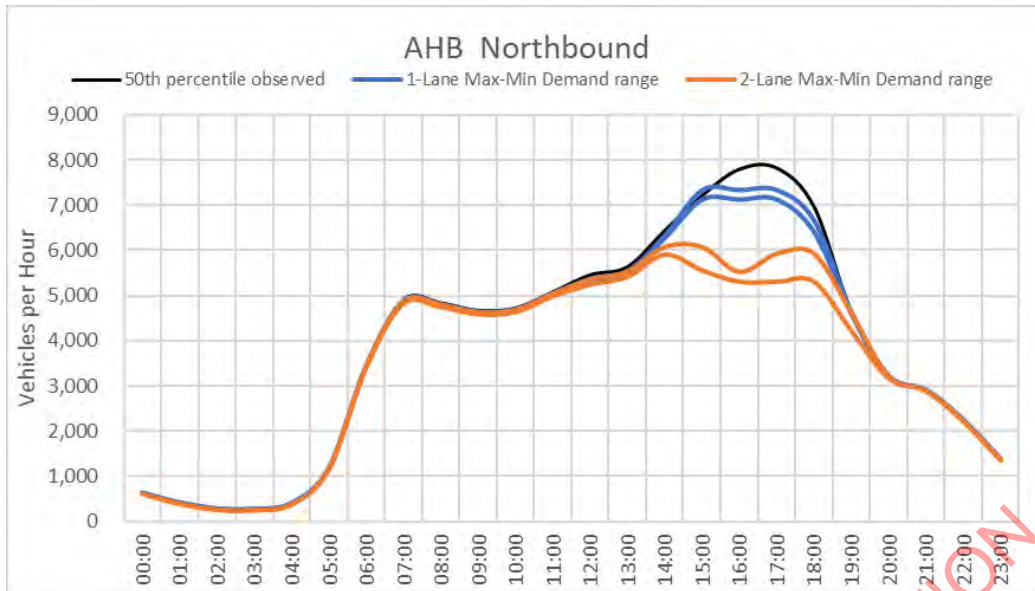

Figure 23 – AHB northbound – maximum and minimum reductions in traffic demands assumed for each option

Once initial reduced AHB vehicle volume profiles were generated a number of top-down “sanity checks” were performed to test their reasonableness. These checks were based on relevant observed AHB flow profiles from the following actual demand reduction scenarios, combined with the latest AFC modelling results in relation to a potential congestion charge (see Figure 24 and Figure 25):

- COVID Alert Level 3 step 1 (October 2021)
- COVID Alert Level 3 step 2 (November 2021)
- The incident of September 2021 when two lanes on the AHB were closed for two weeks.

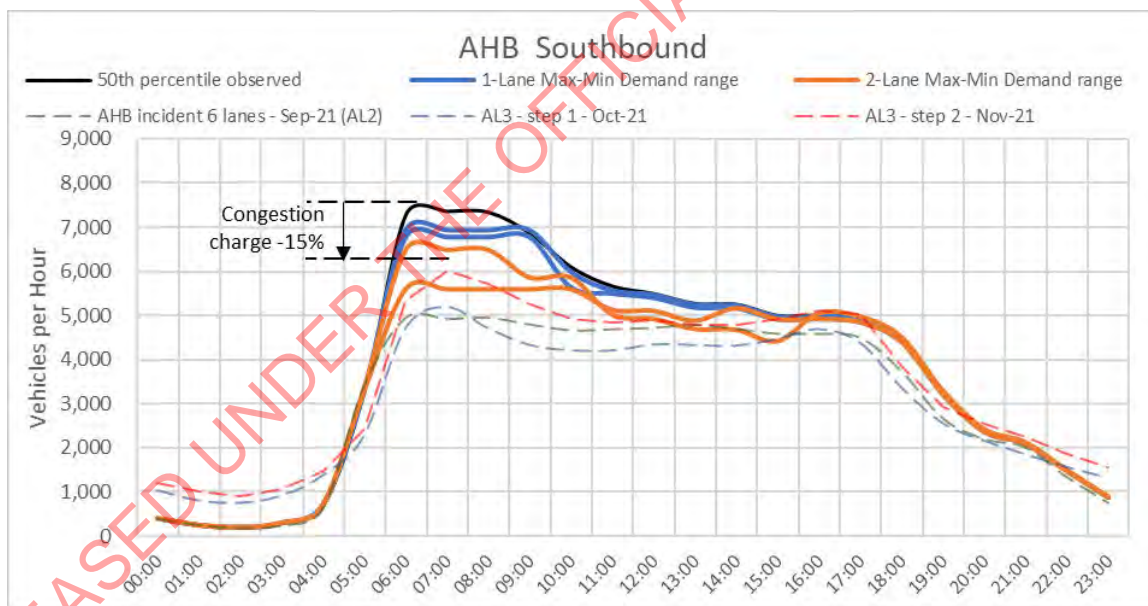

Figure 24 – Top-down sanity check on AHB southbound demand reductions

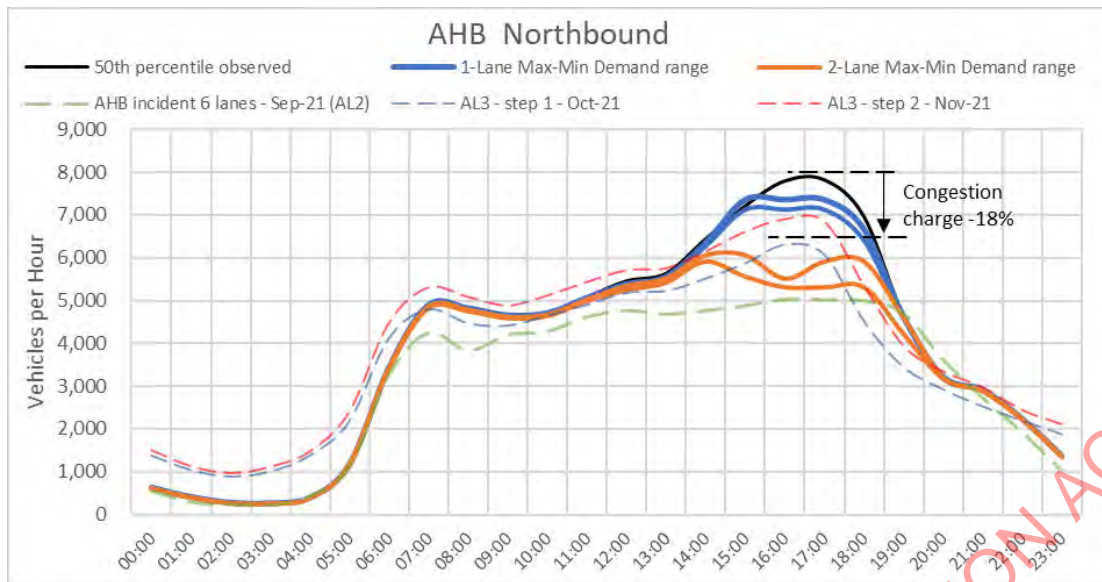

Figure 25 - Top-down sanity check on AHB northbound demand reductions

It seems reasonable that the demand reductions for 1-lane option are substantially less than are anticipated for a congestion charge, given that congestion charging is considered the most effective demand management tool<sup>5</sup>. It also seems reasonable that the peak demand reductions for the 1-lane option do not reduce the demand to below 4-lane capacity (as doing so would reduce congestion below 2019 levels, which it is clear travelers are already prepared to tolerate).

The reduced demand range for the 2-Lane option aligns well with the demand reductions anticipated under congestion charging – if congestion charging is expected to deliver this level of peak demand reduction it was judged unreasonable for a 40% reduction of peak capacity alone (a loss of two out of five lanes) to achieve much more.

The most recent two periods of COVID Alert Level 3 also align reasonably well with the 2-lane option demand reduction range. This would indicate the assumed demand reductions for the 2-lane option are likely on the generous side as they are intended to represent a permanent demand reduction as opposed to the temporary reductions achieved in periods of Alert Level 3. In every period of Alert Level 3 AHB demands consistently trended upward over the period (see Figure 26).

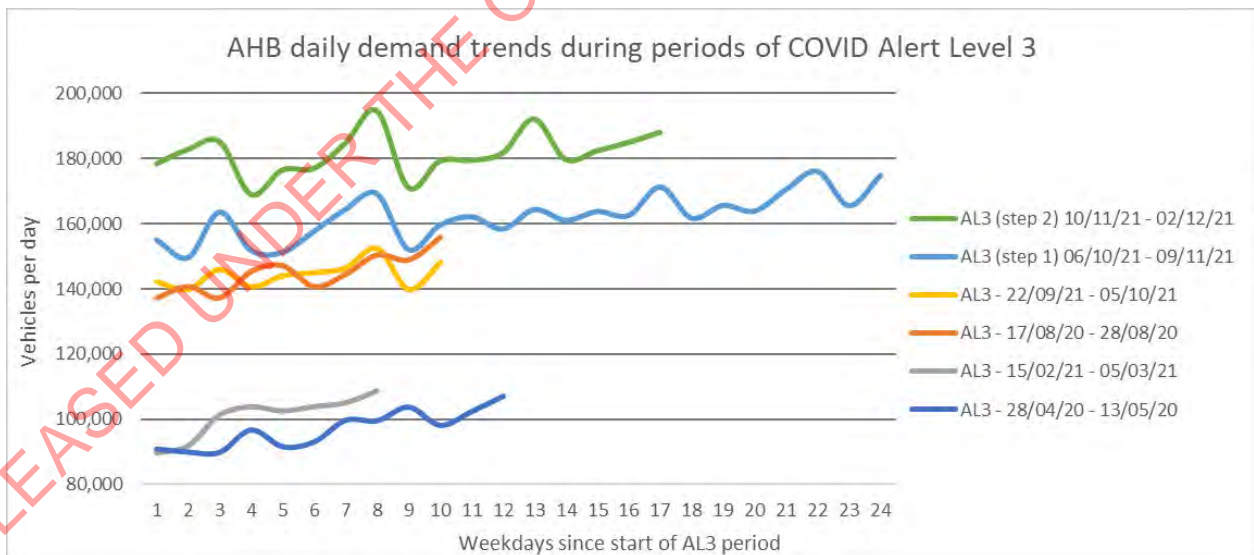

Figure 26 -AHB daily demand trends during periods of COVID Alert Level 3

Finally, the two-week period during which the AHB was reduced to two lanes in September 2020 (as a result of the truck impact incident) resulted in a flow profile across the AHB of below the reduced demand range for the 2-lane option (noting that the peak flows during the incident period are reflective of capacity, not demand). This seems reasonable to two reasons: firstly, the September 2020 incident occurred in during COVID Alert level 2, meaning a degree of demand

<sup>5</sup> The Congestion Question – Technical Report, July 2020

reduction was already in place on top of which the additional demand reduction occurred. Secondly this was also a temporary situation with the demands trending upward over the two week period – indicating that the same level would be unlikely to be achieved on a permanent basis (the profiles in Figure 24 and Figure 25 are based on the average for the two-week period).

## 5.2 Traffic Capacity

The capacities in Table 2 were adopted for the AHB and St Mary's Bay were adopted in the tier two assessment.

*Table 2 – Traffic capacities used in the tier two assessment*

Location	1-Lane Option			2-Lane Option	
	3-Lane (veh/hr)	4-Lane (veh/hr)	5-Lane (veh/hr)	3-Lane (veh/hr)	4-Lane (veh/hr)
	Maximum Minimum	Maximum Minimum	Maximum Minimum	Maximum Minimum	Maximum Minimum
St Mary's Bay NB	4,650	6,200	7,750	n/a	6,200
	4,650	6,200	7,750		6,200
AHB NB	5,273	7,030	n/a	4,991	n/a
	5,273	7,030		5,202	
Onewa to AHB weaving area	4,920	6,560	n/a	4,920	n/a
	4,920	6,560		4,920	
AHB SB	4,920	7,030	n/a	4,997	n/a
	4,750	6,840		5,202	

Determination of actual traffic capacity from traffic detector data is only possible when the location in question forms a bottleneck. In other words, when demand reaches capacity at (or very close to) the measured location – leading to flow breakdown and congestion forming upstream of this, while unimpeded free-flow continues downstream. This situation only occurs on the AHB in the 3-lane configuration. An empirical evaluation was undertaken to validate base values for the 3-lane capacity values utilised (See Appendix D for details). Base values mean without layout modifications to accommodate the active mode facility. Based on the initial layout drawings produced a reduction was applied to the 3-lane capacity of the options to account for friction effects at the entry point to the modified layout. The maximum reduction applied was 5% of the total 3-lane base capacity.

## 5.3 Network Traffic and Customer Journey impacts

### 5.3.1 Overview of Network Traffic Impacts

Figure 27 below summarises the anticipated impacts on the level of network congestion across the entire motorway network (including on-ramp queuing delays).

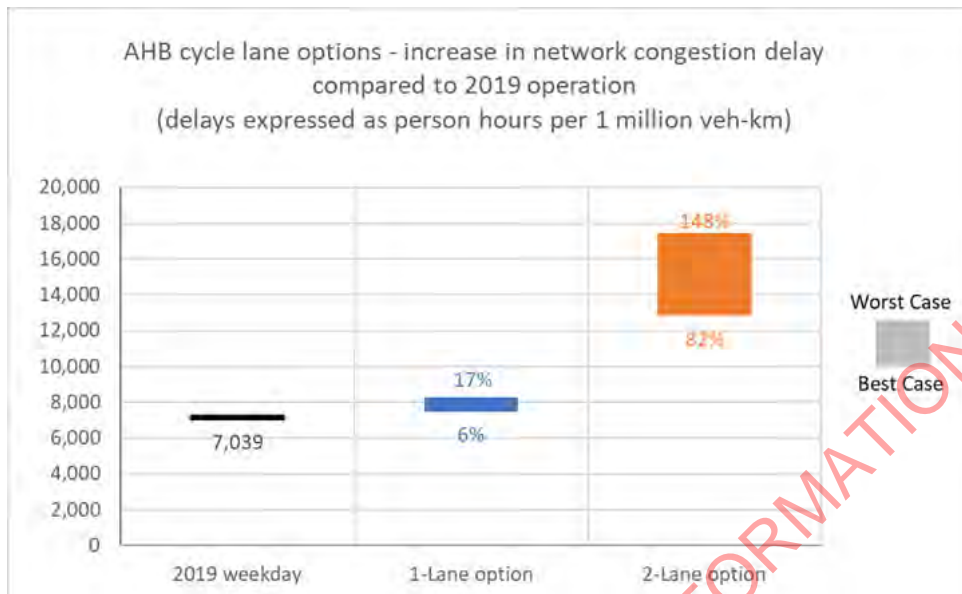

Figure 27 – Tier Two assessment – anticipated impacts on overall network congestion

The 1-Lane option results are in line with the results of the tier one assessment for the equivalent option (option 3a in the tier one assessment), showing a moderate increase in overall network congestion delays. The 2-Lane results, whilst showing considerably lower impacts than the tier-one assessment are still (predictably) much larger than the 1-Lane option impacts.

Figure 28 and Figure 29 indicate the relative distribution of AM and PM peak congestion across the network for the BEST case for each option (Minimum Demand – Maximum Capacity) compared to a typical day in 2019.

In addition to the expected large increase in congestion on SH1 in the 2-Lane option (northern motorway in the AM peak, northern and southern motorways in the PM peak), traffic re-routing to the WRR generates considerable additional congestion on SH20 and SH16. This reflects what the tier-one assessment showed from examination of data from the period 2-lanes were unavailable on the AHB for two weeks in September 2021. Analysis of data from this event indicated that loss of two lanes for traffic on the AHB reduces network capacity to a level similar to before the Waterview Tunnel was opened. This underlines the strategic importance of the AHB's traffic capacity to regional accessibility.

The 1-Lane option leads to increased SH1 congestion in the PM peak in both directions approaching the bridge, but to a much lower extent than the 2-Lane option. The AM peak congestion on the northern motorway appears slightly improved compared to 2019, indicating the assumed mode shift reduces AM peak demand enough to offset the loss of 1 lane of capacity on the bridge at this time of day. The output summaries for each scenario in Appendix E provide more detailed results of corridor congestion patterns over the whole day.

These impacts also spread onto the arterials adjoining the motorway, with Figure 30 indicating how the total amount of vehicles queued around the network at on ramps would be impacted in the BEST case for each option (Minimum Demand – Maximum Capacity). The 2-lane option would likely lead to more than a doubling of on ramp queues in the PM peak from a peak of around 4,400 vehicles in the base model to over 10,000 vehicles in the 2-Lane option. This would have a severe impact on the operation of the network and would seem to signal the likelihood of a broader impact on travel behaviour beyond just trips that cross the harbour. Although this may involve some broader mode shift it would mean reduced regional mobility as the price of a strategic active mode connection across the AHB. If this involved a significant magnitude of trip suppression (cancelled trips) this may even have adverse impacts on the region's economy.

AM Peak 7-9am

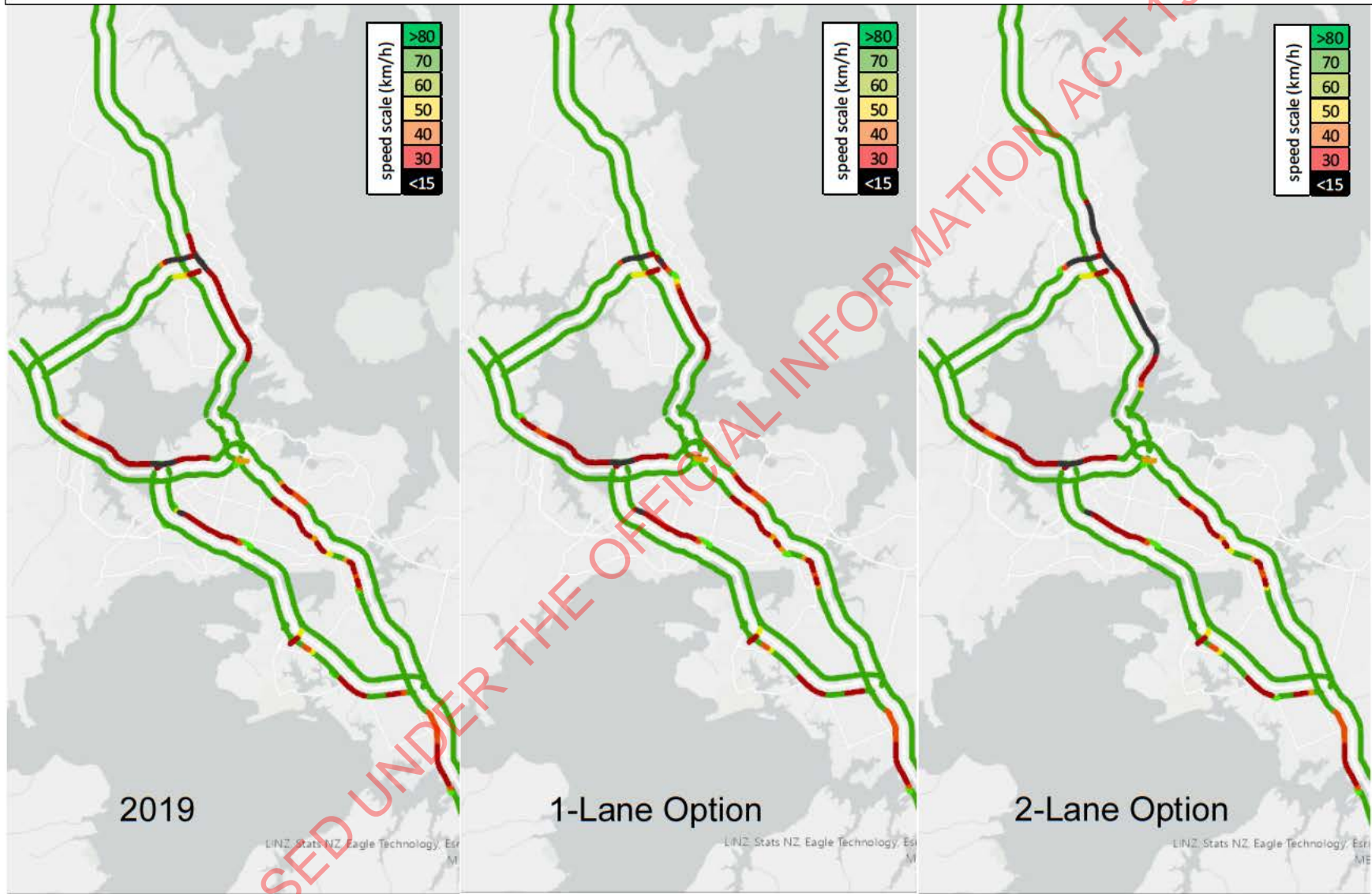

Figure 28 – Tier Two assessment AM peak network congestion impacts



PM Peak 4-6pm

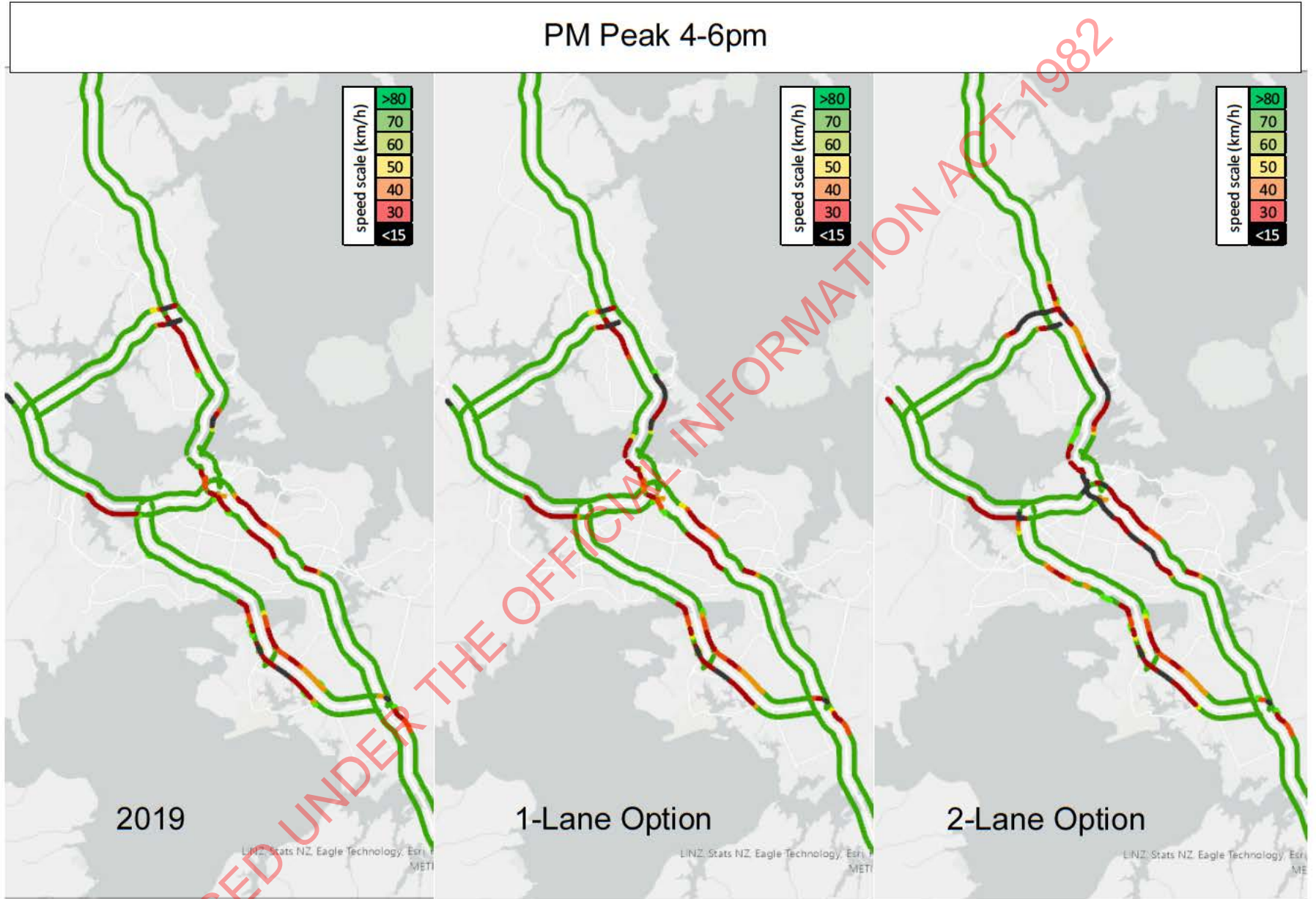

Figure 29 - Tier Two assessment PM peak network congestion impacts



Figure 30 Network-wide on ramp queues, 2-Lane option 2 (top) and 1-Lane option (bottom) P50 demands  
(In each case model 2 is the option and model 1 is the base model)

### 5.3.2 Impacts on Economic Productivity

The 2-Lane option is likely to have a considerable impact on freight both in the inter peak as well as PM peak periods. Between 12pm and 8pm around 5,000 heavy commercial vehicles traverse the AHB each day. In the BEST case (minimum demand – maximum capacity) delays on the approaching corridors of SH1 in each direction are around 20-30 minutes over this period.

In the 1-Lane option the impacts to freight are much less, but still likely of economic consequence. Delays on the approaching corridors are around 5-8 minutes between 4pm and 8pm affecting some 2,000 heavy commercial vehicle movements across the bridge each day.

## 5.4 Outcome of Tier Two Assessment

The main outcomes of the tier three assessment can be summarised as follows:

- The impacts of the 2-Lane option on congestion, delay and emissions across the motorway and adjoining arterial network are likely to be very high. On this basis the 2-lane option was not carried forward to the tier three assessment.
- The impacts of the 1-Lane option appear to be moderate based on the tier two assessment:
  - There are no impacts in the AM peak - the demand assumptions and modelling indicate a slight improvement in congestion southbound on the northern motorway may be possible. However, the loss of one general lane on the AHB is likely to adversely impact the travel time reliability of services on the northern busway. The spare capacity currently provided by the 5-lane capacity of the AHB at this time of day protects busway services from the delays general traffic experience further upstream. A loss of PT travel time reliability is likely to undermine the attractiveness of this mode – which is assumed as constant in the demand shift assumptions.
  - In the PM peak congestion levels are increased both southbound and northbound on approach to the AHB (results in Appendix E indicate this starts in the middle of the day when demand in both directions exceeds 3 lanes capacity – with congestion building as demand continues to increase in BOTH directions into the PM peak). Note this issue could be exacerbated by a congestion charge if it applies only in the peak periods as the latest modelling indicates a 6%-7% increase in interpeak traffic demands<sup>6</sup>.
- The 1-Lane option warranted a more detailed investigation and was carried forward to the tier three assessment.

<sup>6</sup> Info supplied by Auckland Transport from the latest model update prepared for the TCG Steering group – model refresh 27\_1\_2022

## 6. TIER THREE ASSESSMENT

### 6.1 Traffic Demands

AHB traffic demands used for the tier three assessment were enhanced in two ways:

1. Improvement to the P50 base AHB demands in the CTM to better match observed values from 2019 at the hourly level. For tier-two the CTM demands had only been adjusted to match the observed 2019 P50 **daily** demands by globally factoring down the CTM demands across the whole day. For tier three more precise demand changes to CTM demands were undertaken better match the observed P50 hourly profile in each direction over the day.
2. A 90<sup>th</sup> percentile (P90) equivalent set of demands for the CTM were developed using the same approach as above to adjust the original CTM demands hour-by-hour without any global daily factoring (as these were already close to the observed 2019 P90 demands on the AHB – see Figure 31 and Figure 32).

Initial tests of the 1-Lane option with the adjusted P50 demands and enhanced capacities showed no substantial change in results from the tier-two assessment. Therefore, for brevity this section will only present results for the additional assessments based on using the P90 demands. Note that the actual impacts associated with the 1-Lane option would be expected to fall somewhere between the tier two assessment results and the tier three assessment results 40% of the time.

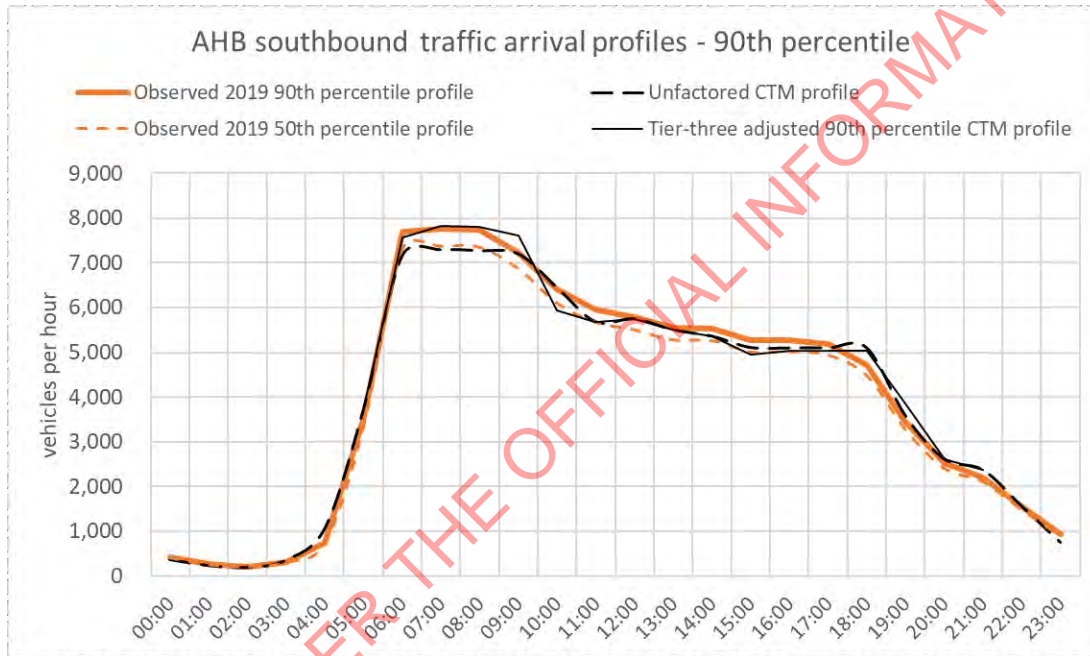

Figure 31 - 90<sup>th</sup> percentile southbound CTM profiles used in tier three assessment

In the southbound direction the tier-two CTM arrival profile was low in the AM peak and high in the early inter peak period and was adjusted to better match the observed 90<sup>th</sup> percentile profile from 2019 data.

In the northbound direction the tier-two CTM arrival profile was already a good match to the observed 90<sup>th</sup> percentile profile from 2019 data and was used for tier three unadjusted.

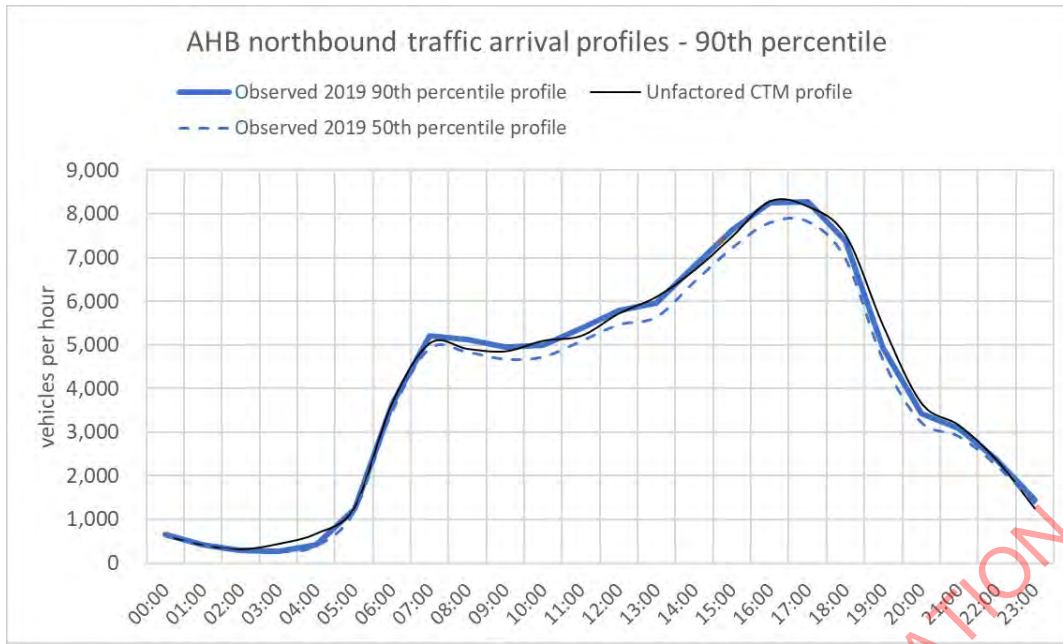

Figure 32 - 90<sup>th</sup> percentile southbound CTM profiles used in tier three assessment

Initial tier three CTM tests used the P90 demands with the same maximum-minimum demand reductions as the tier two assessment for the 1-Lane option (Level 1 and Level 2 mode shift demand reductions, with peak spreading). This resulted in large congestion impacts across the network, indicating additional demand shift would be likely to occur as a consequence. Given the constrained timeframe it was decided to re-run the tier three P90 assessment using the Level 3 mode shift demand reduction (with peak spreading, but with no re-routing).

This meant there was only one set of demands to test the 1-Lane option with at tier three. However, this allowed the sensitivity of the forecast impacts to the small variations in capacities through St Maty's Bay and across AHB to be demonstrated more easily (see next section). Figure 33 summarises how the tier demands were derived.

### Tier 3 Assessment – Summary of Option Demand Scenarios

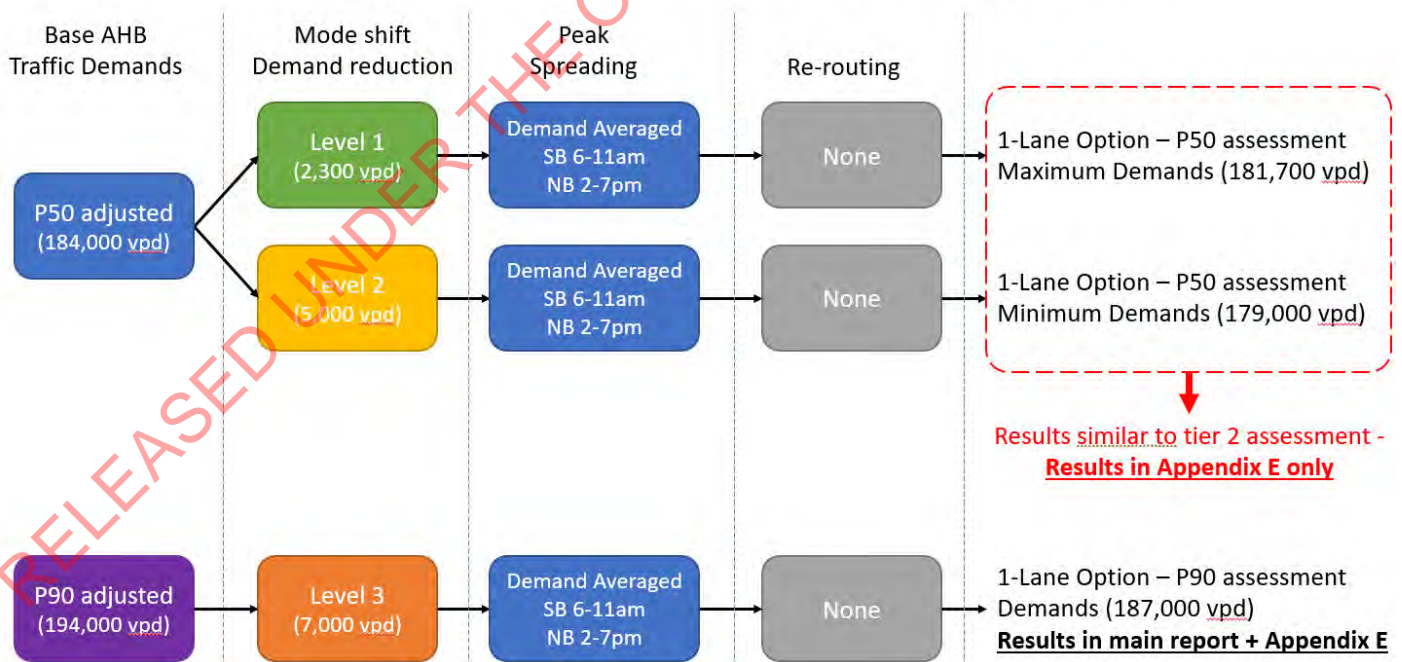

Figure 33 – Summary of tier three demand scenarios

Figure 34 and Figure 35 illustrate the resulting demand profiles (shown compared to the demands used for the 1-Lane option in the tier two assessment).

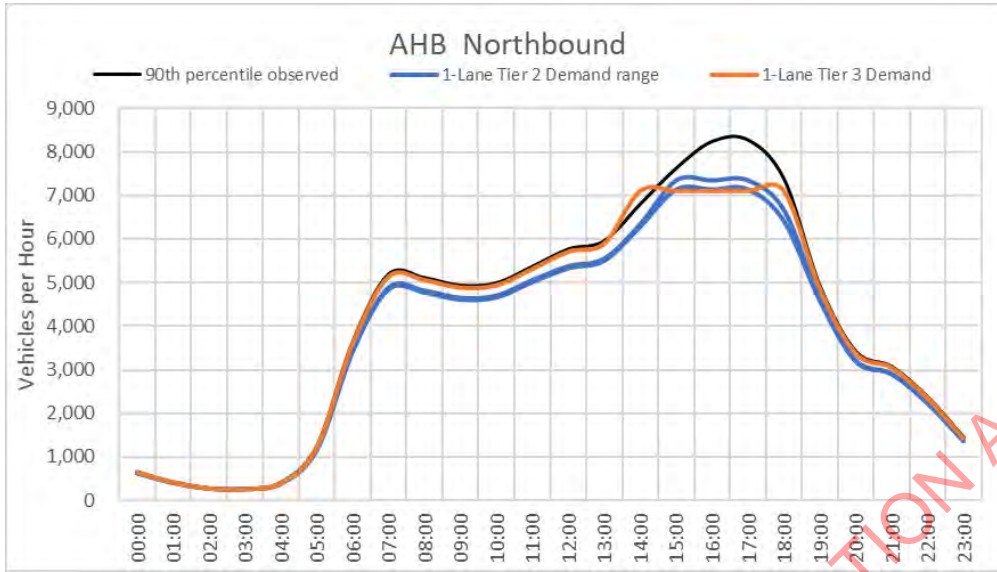

Figure 34 – Northbound demands used for tier three assessment of 1-Lane option (compared to tier 2 demand range for 1-Lane option)

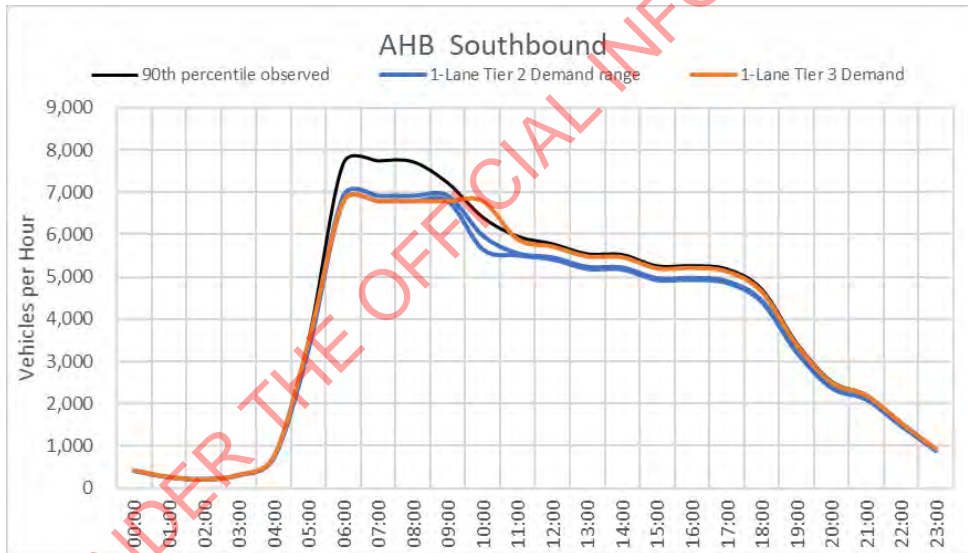

Figure 35 -- Southbound demands used for tier three assessment of 1-Lane option (compared to tier 2 demand range for 1-Lane option)

RELEASED UNDER THE OFFICIAL INFORMATION ACT 1982

## 6.2 Traffic Capacity

For the tier three assessment the capacity of the critical sections of SH1 from Onewa Road to Shelley Beach Road (southbound) and Victoria Park Tunnel to Stafford Road (northbound) were investigated in more detail to ensure the base and option models were calibrated as closely as possible to relevant observed values.

A valuable source of data to assist in this was the real-time and historic dashboard set up by the ASM that track AHB volumes and speeds in each direction every five minutes (see Figure 36). This dashboard was set up to assist in optimising the time of the MLB moves. It was particularly useful as in addition to tracking traffic volume every five minutes in each direction, it also tracks the average speed on approach to the bridge from 2-3km upstream to the foot of the bridge. This allows periods of the bridge flowing at capacity to be readily identified.

In addition, in the final week of COVID Alert Level 3 in December the AHB remained in 4-4 configuration 24 hours per day. On several occasions that week the northbound direction reached capacity in the afternoon - providing useful data to help validate capacity assumptions for the 4-lane configuration for the tier three assessment.

Capacity conditions are reached daily in the 3-lane configuration both northbound and southbound, which allowed values from the historical dashboard to be used to establish a suitable capacity range for the base model. A full stochastic capacity assessment using 12 months of empirical data was carried out to validate these values (see Appendix D).

Calibrating the capacity through Saint Mary's Bay northbound was harder given maximum combined flows that the Victoria Park Tunnel and the Fanshawe / Beaumont signals at the top of the Fanshawe street on ramp can discharge is slightly less than the capacity of St Mary's Bay in either 4 or 5 lane configurations. The capacity through Saint Mary's Bay was ultimately calibrated using Victoria DoT's recommended Maximum Sustainable Flow Rates (MSFRs) and comparison to maximum observed flows rates from historic detector data through St Mary's Bay.

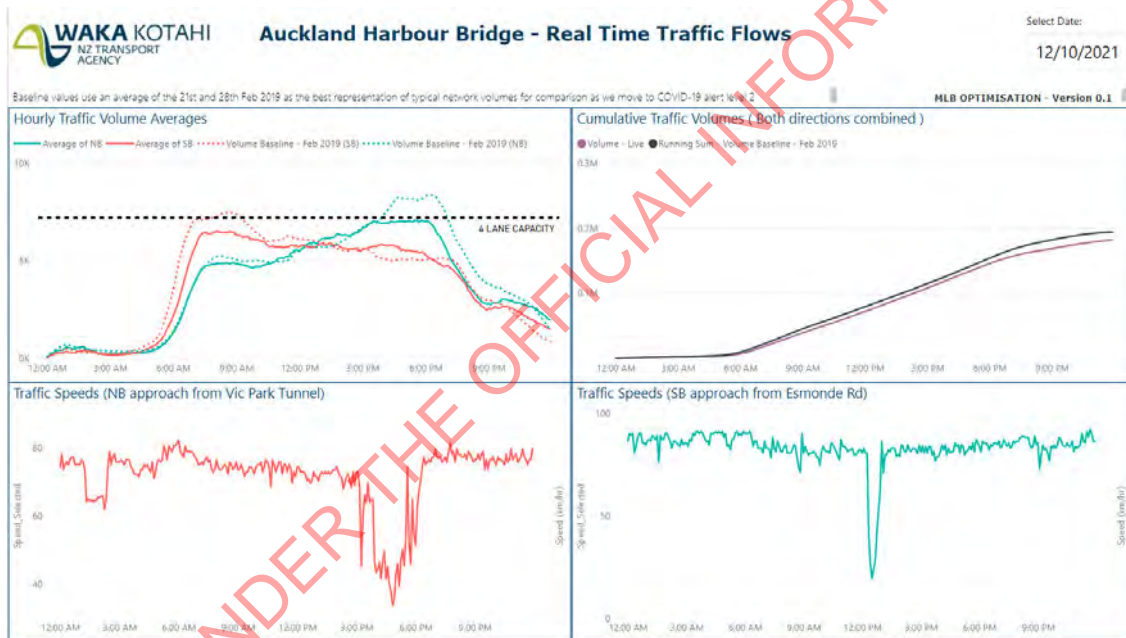

Figure 36 – ASM AHB real-time and historic traffic flow dashboard

For the 1-Lane option, the northbound capacities were taken the same as the current operation in 3-lane and 4-lane configurations. This assumes the Fanshawe right-hand peak on ramp remains CLOSED in the PM peak with St Mary's Bay operating at 4-lanes and Fanshawe Street on ramp operating at one lane. It was assumed the ramp meter at the left hand Fanshawe Street on ramp would remain OFF in the PM peak.

In the southbound direction estimating relevant capacities for the 1-lane option was more difficult, given the active mode facility would be implemented in lane one of the southbound clip-on. Relevant factors considered in the assessment of southbound capacities were:

- The likely lane width for the general traffic lane adjacent to the active mode facility
- The nature and width of separation between the traffic lane and the active mode facility
- The type of physical separation between the traffic lane and the active mode facility (barrier, kerbed separation, safe-hit post, etc)

- The potential for a reduced speed limit to be applied to the traffic lane adjacent to the active mode facility (we understand it has been suggested a 50km/hr speed limit could be applied to the remaining clip-on traffic lane only)
- The location of the gateway treatment where the active mode facility moves laterally from the shoulder into the existing lane 1. In particular whether it is co-located with the area of intense weaving between where Onewa Road on ramp joins and the start of the red chip separating the clip-on lanes from the main truss lanes

The impact of a lower speed limit on motorway lane capacity is not well established. Research in the area has produced a wide range of potential impacts: a review of the research by Soriguera et al. (2017)<sup>7</sup> indicates range of capacity on a motorway at 50km/hr of anywhere between 1,800 and 1,500 vehicles per hour per lane (see Figure 37 below). This means it is unclear whether the friction of the other aspects of the layout or a 50km/hr speed limit would dominate.

The resulting ranges of capacity values for the AHB and St Mary's Bay used for the tier three assessment are summarised in Table 3.

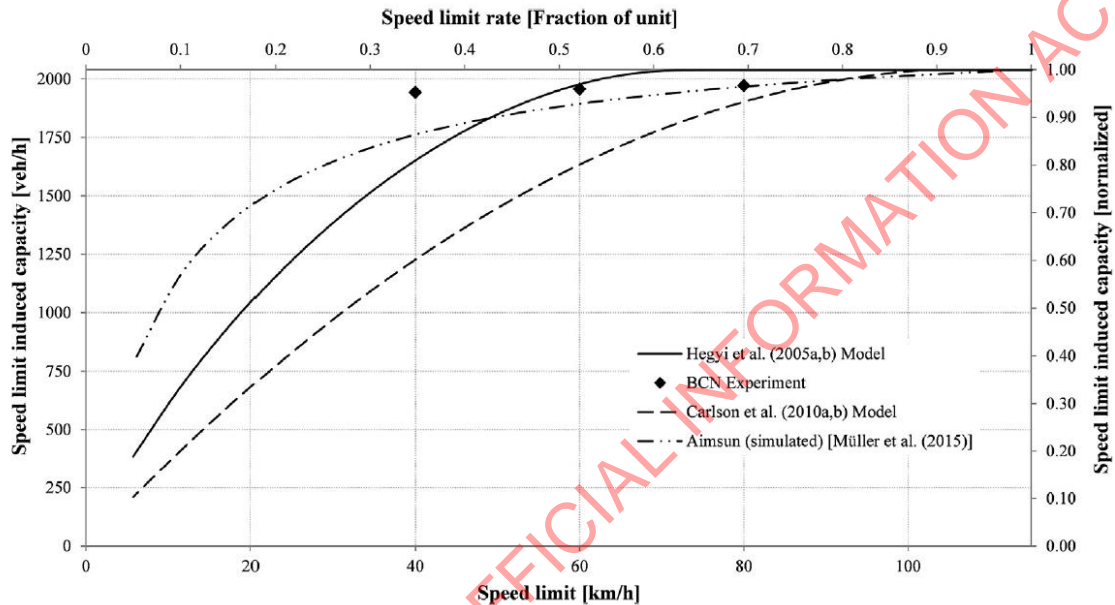

Figure 37- Capacity–speed limit relationship according to different studies (from Soriguera et al 2017)

Table 3 – Capacity ranges used for AHB and St Mary's Bay in Tier Three assessment

Location	3-Lane (veh/hr)	4-Lane (veh/hr)	Notes
	Maximum Minimum	Maximum Minimum	
St Mary's Bay NB	4,800 4,725	6,400 6,300	Potential minimum established from max AHB PM flows at 5-lanes observed from AHB dashboard when the approach to AHB is flowing freely - less observed flow joining at Curran St. Max value incremented to align with MSFR recommended by Victoria DoT
AHB NB	5,200 5,000	7,200 7,040	3-lane based on max-min range of sustained NB capacity flow observed via AHB dashboard. 4-lane based on max-min sustained NB capacity 4-lane flow in Dec-21 observed via AHB dashboard. Assume no impact of active mode facility on NB capacity.
Onewa to AHB	4,920 4,920	7,040 6,840	3-lane maximum/minimum based on observed sustained SB capacity flows via AHB dashboard. No allowance for effect of active mode layout as concept layout

<sup>7</sup> Soriguera F, Martinez I, Sala M, Menendez M. "Effects of Low Speed limits on Freeway Traffic Flow", Transportation Research Part C 77 (2017)



Location	3-Lane (veh/hr)	4-Lane (veh/hr)	Notes
	Maximum Minimum	Maximum Minimum	
weaving area SB			from May-June 2021 assessment shows the active mode facility does not move into lane 1 until clip-on and truss lanes are already physically segregated. 4-lane values set equal to AHB capacity values as lane-changing is less intense without RHS lane drop.
AHB SB	5,040 4,800	7,040 6,840	All values based corresponding NB values with a 200vph reduction applied to the lane adjacent to the active mode facility (equivalent to between an 11% and 14% reduction for this lane).

### 6.3 Network Traffic and Customer Journey impacts

#### 6.3.1 Overview of Network Traffic Impacts

Figure 38 below summarises the anticipated impacts on the level of network congestion across the entire motorway network (including on-ramp queuing delays) for the higher demand days assessed at tier three. As the demand level is fixed between the two scenarios this difference is entirely due to the uncertainty in capacity that might be achieved in either direction on the AHB. The difference between the best and worst case is considerably wider than the tier two assessment of the 1-Lane option, indicating the sensitivity of the assessment to minor changes in capacity assumptions.

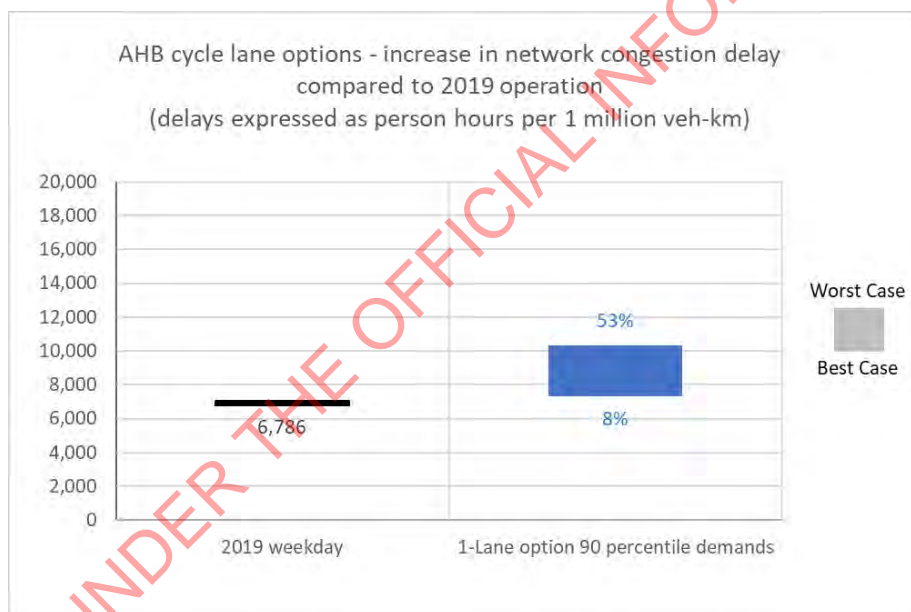

Figure 38 – Tier three assessment – 1-Lane option impacts on network congestion at high demand levels

Figure 39 and Figure 40 on the following pages illustrate the differences in distribution of the increased congestion around the network in the AM and PM peaks between the Maximum and Minimum capacity scenarios compared to 2019. At the higher-than-average levels of demand tested the impact of removing a single lane on the bridge is clearly very sensitive to the ultimate capacity that could be achieved with the new layout, given the change in total AHB capacity between maximum and minimum scenarios is only around 3%-4%.

This sensitivity also carries over to impacts on the arterials, with Figure 41 indicating how the total amount of vehicles queued around the network at on ramps would vary between maximum and minimum capacity assumptions for the AHB. In the worst-case total on ramp queues could be over 30 lane-km longer than in 2019 (almost entirely along the SH1 corridor between Highbrook and SH18).

At higher demand levels there is also a risk of substantial increased queuing on Fanshawe and Beaumont Streets (see Figure 42). At the lower capacity level queues back up on the on-ramp and would add up to 350 vehicles to existing PM queues back toward the Central City (around 3 lane-km). Note these queues are not due to ramp metering as the meter at Fanshawe on ramp remained off in the model for these tests. As the higher demand shift assumed for the 1-Lane

option at tier three has taken up existing spare PT capacity, rather than further mode shift, the resulting delays are more likely to lead to traffic leaking onto other routes, including Curran Street on ramp, Grafton Gully and Wellington Street (all with undesirable consequences). Any additional shift to active modes on the new facility to avoid the delays out of the city is unlikely to be high enough to address the problem.

There is also the possibility that with the high level of impacts in the low-capacity scenario some traffic would re-route to SH16 / SH18 /SH20. Time constraints prevented any further modelling to test this – however the lack of capacity on these routes (as illustrated by the tier-two results for the 2-Lane option) means this would likely add to problems elsewhere on the network.

RELEASED UNDER THE OFFICIAL INFORMATION ACT 1982

P90 demands AM Peak 7-9am

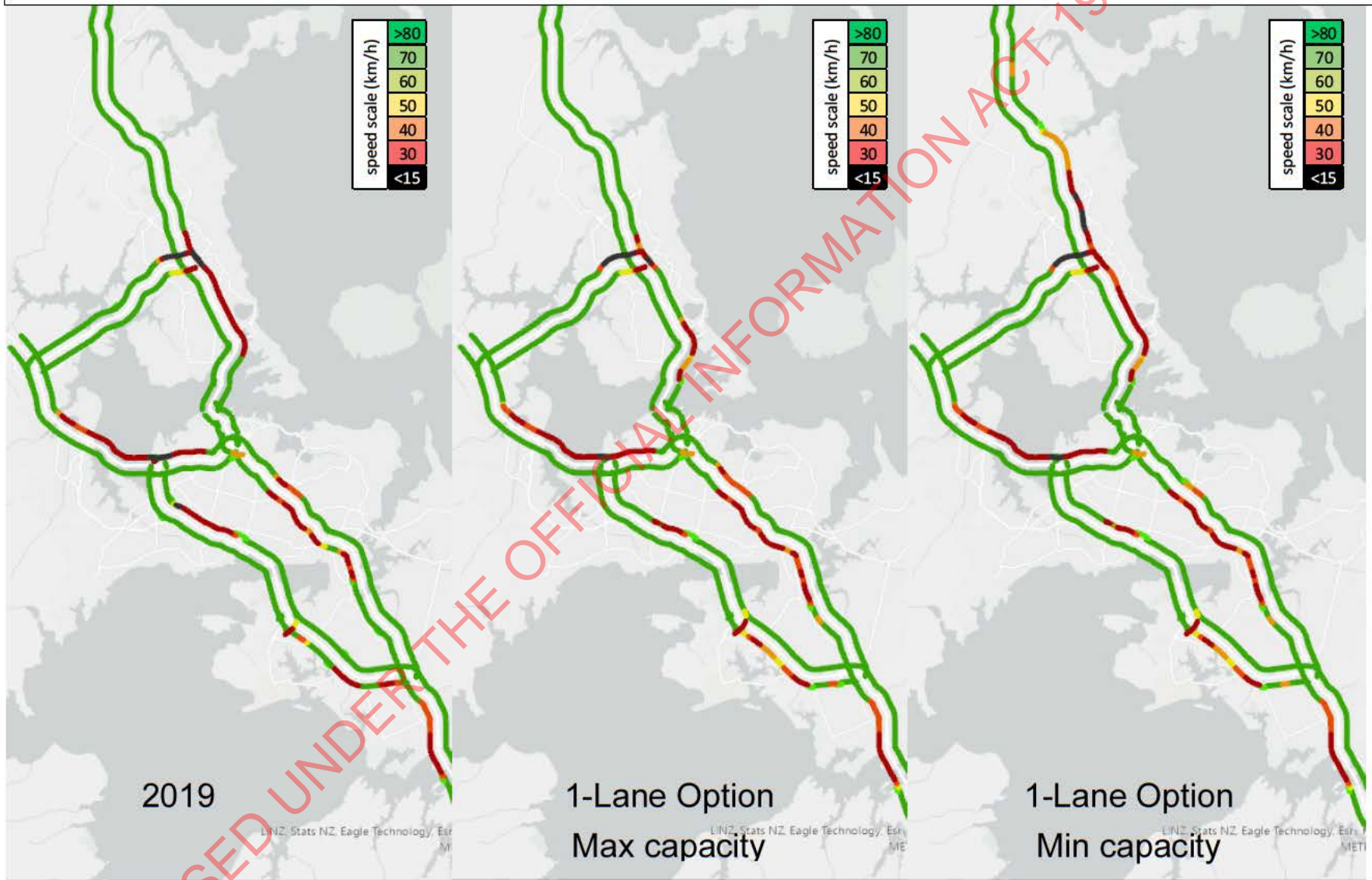

Figure 39 – Tier three assessment – 1-Lane option network congestion impacts AM peak (P90 demands)

P90 demands PM Peak 4-6pm

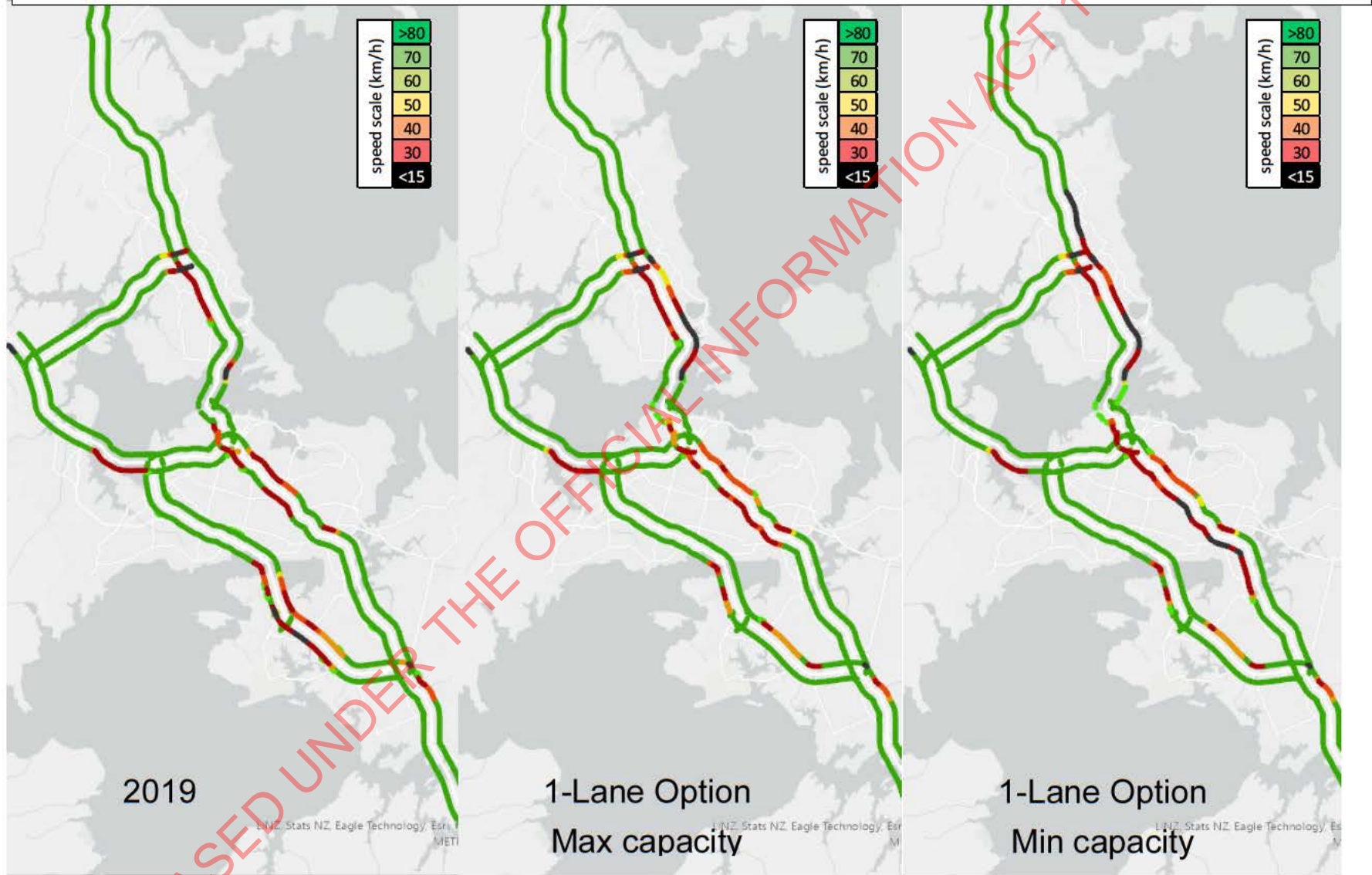

Figure 40 – Tier three assessment – 1-Lane option network congestion impacts PM peak (P90 demands)

RELEASED UNDER THE OFFICIAL INFORMATION ACT 1982

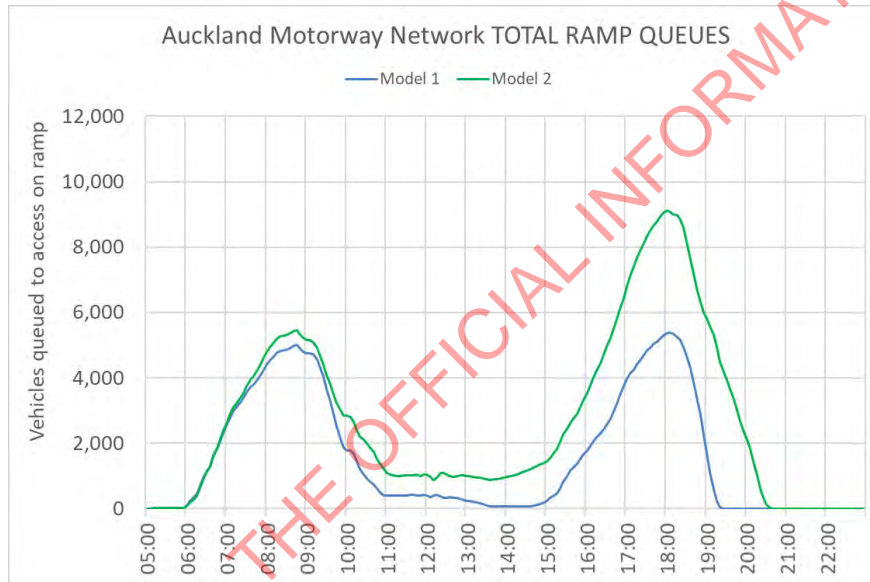
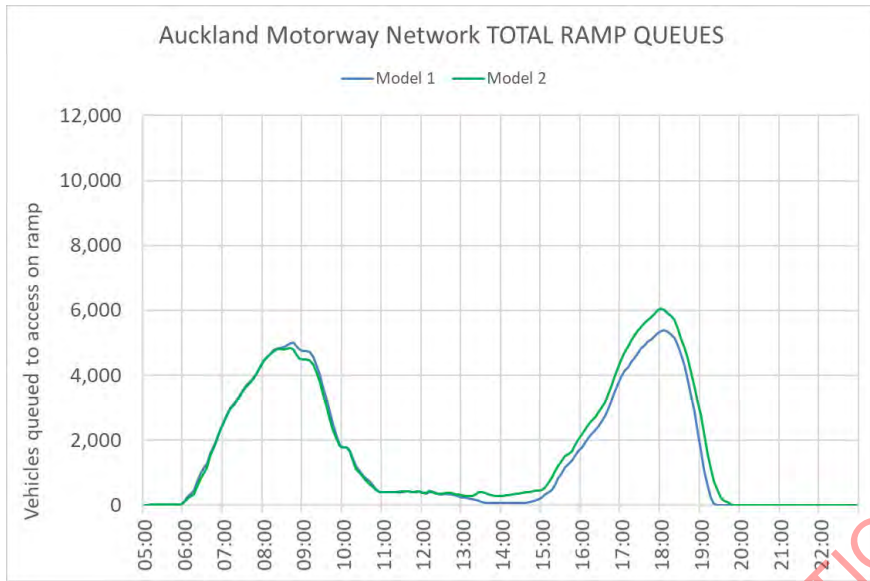

Figure 41 – Network-wide on ramp queues - option 1 90<sup>th</sup> percentile demands  
 (Maximum capacity - top; Minimum capacity – bottom. In each case model 2 is the option and model 1 is the base model)

RELEASED UNDER THE OFFICIAL INFORMATION ACT 1982

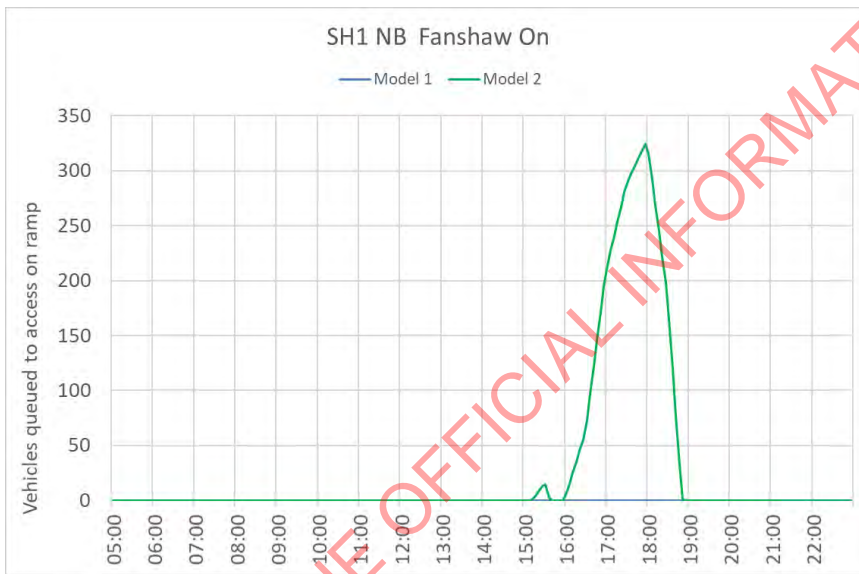
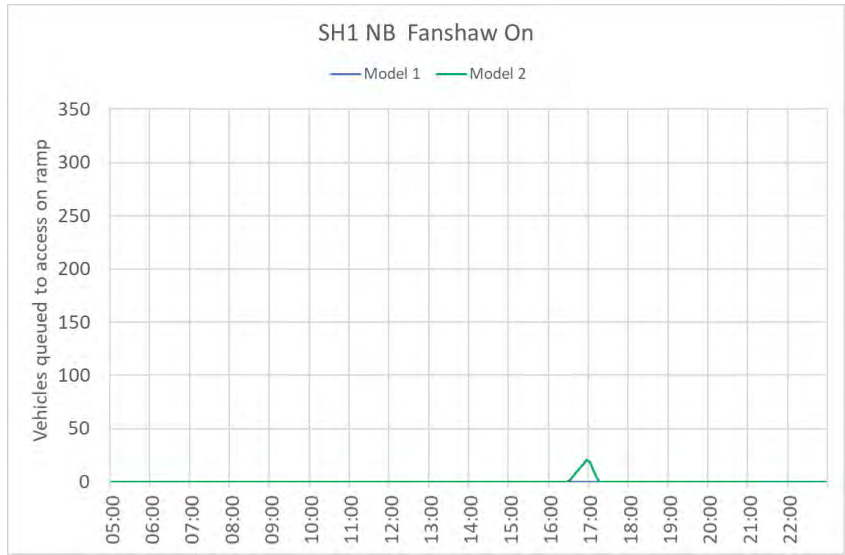

Figure 42 – Fanshawe Street on ramp queues - option 1 90<sup>th</sup> percentile demands  
 (Maximum capacity - top; Minimum capacity – bottom. In each case model 2 is the option and model 1 is the base model)

RELEASED UNDER THE OFFICIAL INFORMATION ACT 1982

### 6.3.2 Impacts on Network Reliability

The analysis of the 1-Lane option with higher demands revealed a major issue that is likely to severely impact the reliability of customer journeys in the inter peak and PM peak periods. During the middle portion of the day AHB traffic demand exceeds three lanes in each direction at the same time for a period of several hours, yet the layout the 1-lane option will only permit four lanes in one of the directions (with the MLBS changing the changing the configuration from four lane southbound to four lanes northbound before the PM peak). This is true in all demand scenarios used for the 1-Lane option in the tier two and tier three assessments (see Figure 43), however the potential for a large deterioration of network reliability as a result manifests as demand levels become relatively high.

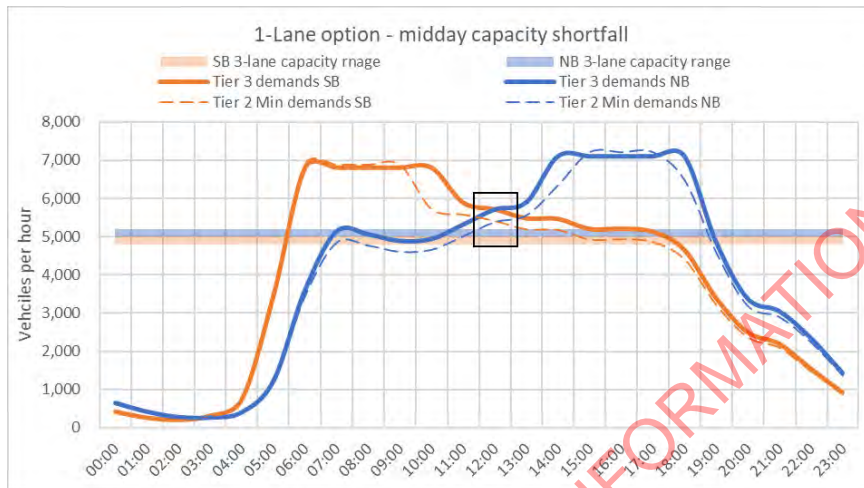

Figure 43 – Midday capacity shortfall in both directions with the 1-Lane option

Whilst the delays for customers in the middle of the day would only be moderate as a result of the capacity shortfall, there will be a knock-on effect into the PM peak for both directions: the backlog is unable to clear as arriving traffic demand continues to increase in both directions into the PM peak and remains above three lanes capacity until at least 6pm (note the current daily buildup of congestion southbound in the afternoon when the bridge is in the 3-lane configuration means the demand is higher than shown in the graph for this period – the graph represents capacity over this period). Delaying the southbound lane reduction from four to three lanes will help to limit the southbound buildup but will increase the risk that the northbound backlog also won't be able to clear – despite the northbound direction gaining a lane. The northbound trigger point appears to be the upstream critical bottleneck at Greenlane – if the queue from the AHB that builds prior to the opening of the fourth lane reaches Greenlane then that critical bottleneck will activate up to two hours earlier than usual. This will cause a cascading impact on conditions on the southern motorway for the rest of the afternoon with queues potentially extending as far as SH20 as the Greenlane bottleneck is unable to clear its own backlog before PM peak demands hit.

Figure 44 illustrates the dynamics of this situation and highlights the importance of optimising the timing of the MLB shift to limit congestion build-up on the northern motorway, whilst simultaneously avoiding triggering a collapse in the southern motorway.

If the 1-Lane option is implemented, it will result in the AHB forming a critical bottleneck in the middle of the day in both directions where one currently doesn't exist. The net result of this will be a less reliable network: on higher demand days the backlog on the southern motorway won't be able to clear, whereas on lower demand days it will. In addition, varying the times of the AHB lane shift to manage this is likely to lead to more highly variable congestion levels on the northern motorway in the PM peak. However, not varying the times will require a consistently early switch time to limit the risk of causing conditions on the southern motorway to collapse. This in turn will lead to some very high PM peak congestion on the northern motorway. The consequence of trying to actively manage and balance these issues is likely to be much wider variability of congestion levels on both corridors leading to the AHB at the same level of variation in day-to-day traffic demands as 2019. This would be likely to significantly reduce network reliability and predictability of customer journeys on the busiest stretch of road in the country.

Northern Mway (southbound)

Southern Mway (northbound)

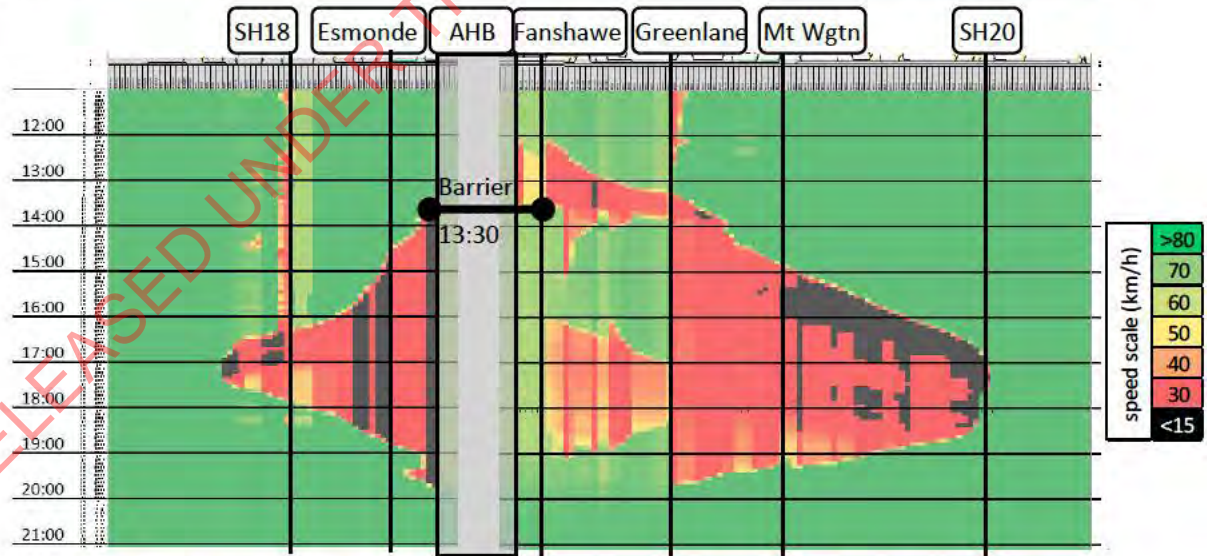
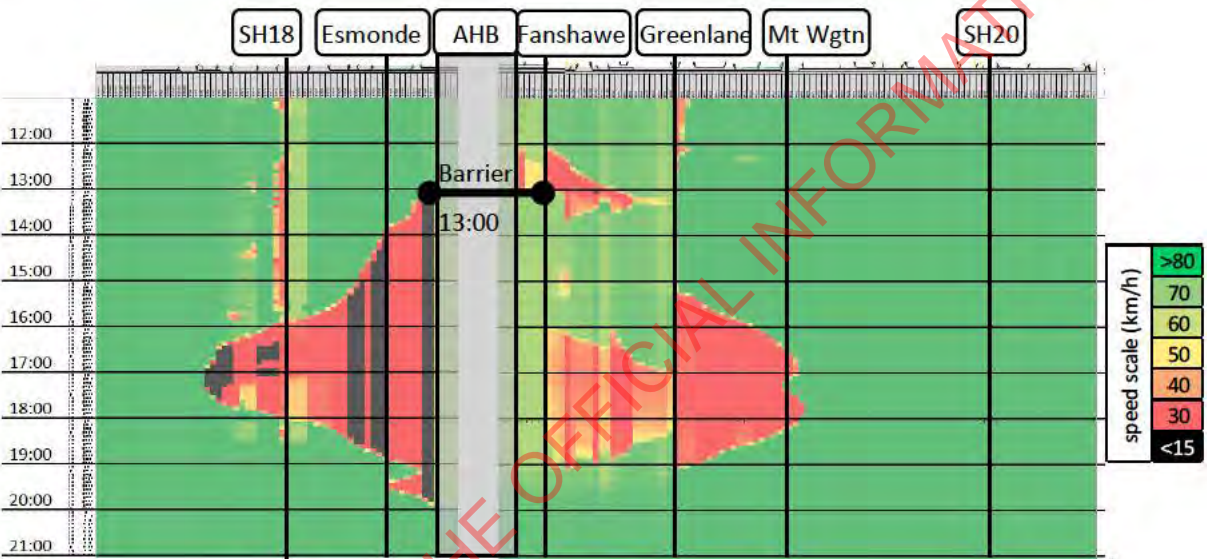
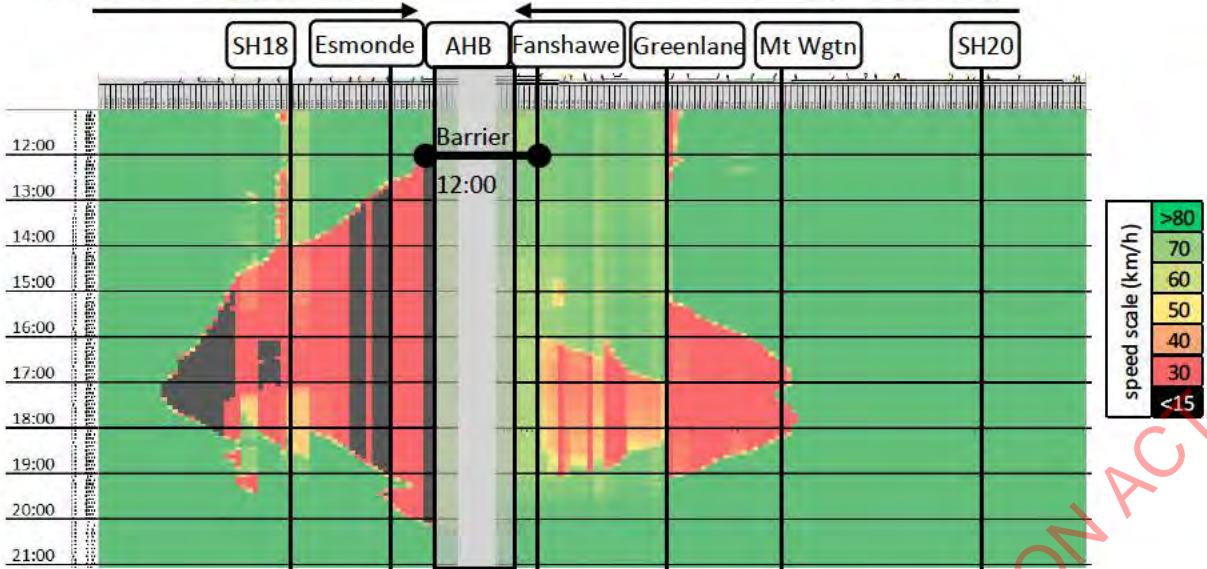

Figure 44 – Sensitivity of Northern and Southern motorway to AHB barrier change time – P90 Demands, MAX CAPACITY SCENARIO



It is considered unlikely that the congestion created during the middle of the day would prompt sufficient further behaviour change to eliminate the issue:

- PT provides a much lower level of service at this time of day than during the peaks, with lower service frequencies and park and ride facilities being full after the AM peak. This means customers would have to rely on local feeder services to reach a busway station and then change service to continue into the city.
- The alternative route via SH16, SH18 and Upper Harbour Bridge is considerably longer for most journeys that start or end on the North Shore.

Data from 2019 suggests most customers are likely to accept considerable delay on SH1 before considering switching routes or modes. Figure 20 indicates in 2019 daily congestion persisted on SH1 southbound between 3pm and 6pm whilst the SH18 route enjoyed up to a 12-minute advantage over SH1 for trips between Albany and the exits for the Onehunga / Penrose. Figure 18 indicates PT patronage southbound over the AHB was very low during the whole afternoon whilst this congestion occurred.

### 6.3.3 Impacts on Economic Productivity

The reliability issue discussed above would have a large adverse impact on freight with some 5,000 heavy commercial vehicle movements across the AHB between 12pm and 8pm each day. The southern motorway between Mt Wellington and Grafton Gully which is heavily impacted by the reduced reliability is the busiest freight route in the country. More widely varying and less predictable delays on this corridor would create significant problems for freight operators and industry logistics.

### 6.3.4 Impacts on Network Resilience

The loss of one traffic lane from a strategic link like AHB is likely to have a substantial negative impact on network resilience and resulting customer journey reliability. To assess this the following incident scenario was run in the CTM on both the base (current) situation and the 1-Lane option<sup>8</sup>.

- One northbound lane on the AHB blocked for 1-hour 4pm to 5pm
- AHB northbound in 4-lane configuration before the incident

The heatmaps in Figure 45 indicate worse and prolonged impacts on the southern motorway. An incident of this type happens fairly regularly in the afternoon in or just prior to the PM peak.

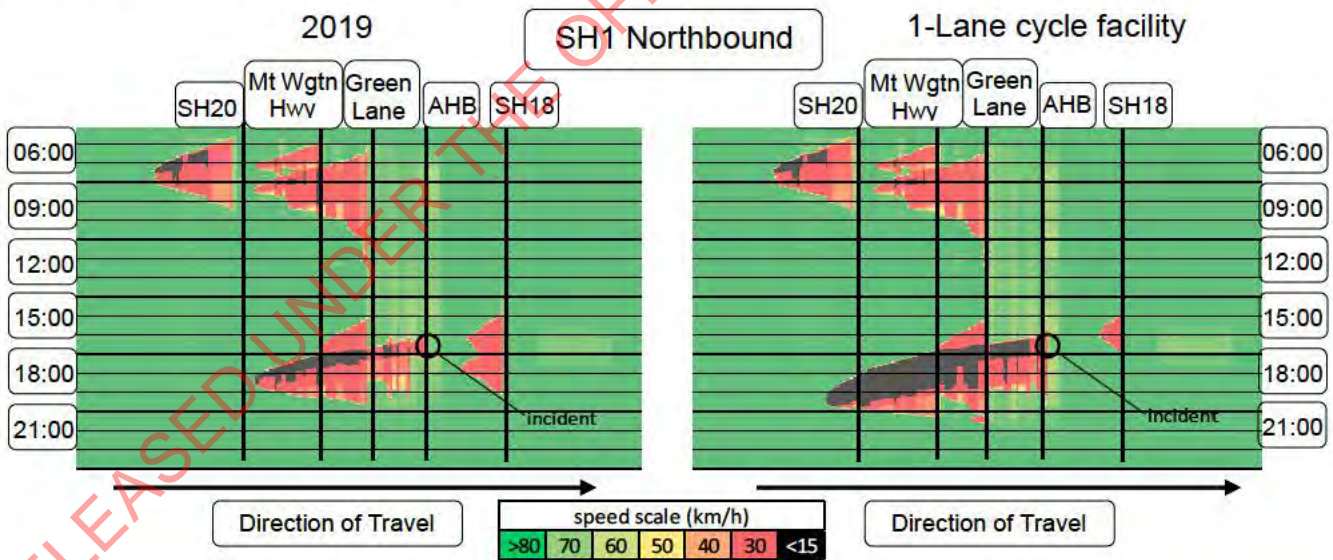

Figure 45 – 1-Lane option – impact of example incident scenario on network resilience (taken from tier one assessment)

<sup>8</sup> This is the same analysis that was reported on for the tier one assessments. Time constraints prevented additional incident scenarios being tested. However, the resilience impact is considered important, so the results of this assessment are repeated here.

## 6.4 Outcome of Tier Three Assessment

The main outcomes of the tier three assessment can be summarised as follows:

- The average impact of the 1-lane option at higher-than-average traffic demand levels is likely to vary between moderate and severe, being heavily dependent on the level of traffic capacity the layout of the remaining lanes on the AHB and its approaches is able to achieve.
- Under the 1-Lane option interpeak and PM peak congestion is likely to vary much more widely between average and high demand days than it did pre-COVID, resulting in a less reliable network and less predictable journeys for people, goods and services. Freight and commercial trips on the SH1 corridor between SH18 and Mt Wellington would likely be heavily impacted by this.
- Enhanced optimisation of the MLB timing would help to mitigate the increased unreliability, using real-time data analytics to adapt the timing of the move to prevailing conditions.
- The loss of one lane for traffic on the AHB is likely to have a major impact on network resilience. Even a short blockage of a single lane anytime between 12pm and 6pm on an AHB with only seven total lanes of general traffic capacity is likely to create delays of a substantially higher magnitude than the same incident under current operation, and the network is likely to take longer to recover to normal conditions.

RELEASED UNDER THE OFFICIAL INFORMATION ACT 1982

## 7. FURTHER OBSERVATIONS

All of the scenarios assessed in tier 2 and tier 3 indicate adverse impacts on traffic across the network to a greater or lesser degree. This leaves the question of what level of demand reduction would be required to avoid all adverse impacts to traffic, and is this level of demand reduction credible? This is not a straightforward question to answer, but an idea can be gained by considering two different approaches. Firstly, the minimum theoretical demand reduction to achieve no impact for each option – in other words if just enough traffic demand was removed at just the right times of day to avoid any remaining excess demand, how much would this be?

To avoid traffic impacts practically all of the time, this was assessed using the P90 demand profiles from 2019 (implying there would only be adverse impacts to traffic on 10% of weekdays – approximately 25 occasions per year). This was combined with the minimum capacity values for the AHB, its approaches and the active facility layout.

Figure 46 and Figure 47 provide a diagrammatic indication of the required minimum demand removal (with the orange shaded areas representing the minimum level of demand across the day that would need to be removed on a permanent basis). In the case of the 2-Lane option the required demand reduction across the day would be 30,000 vehicles, and in the case of the 1-Lane option it would be 11,000 vehicles.

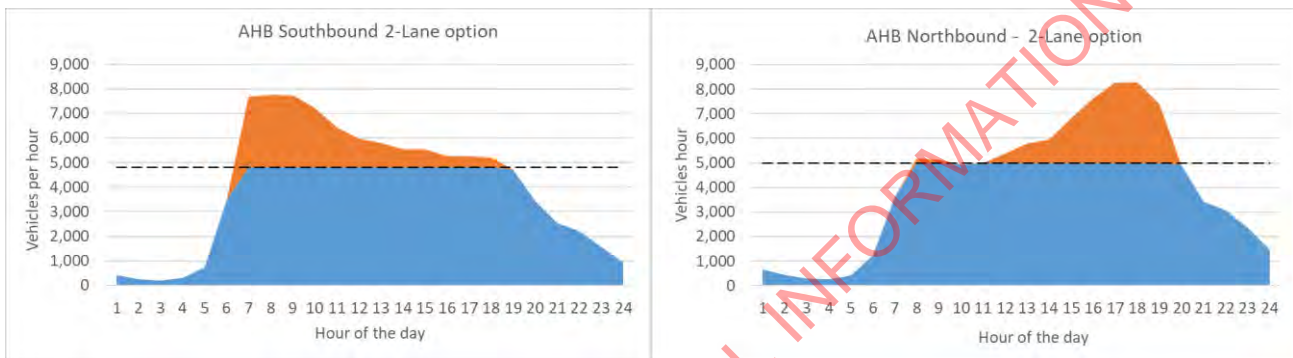

Figure 46 – 2-Lane option – minimum theoretical demand reduction to avoid all traffic impacts



Figure 47 – 1-Lane option – minimum theoretical demand reduction to avoid all traffic impacts

A second way to look at this is to revisit the observed daily demand and congestion impacts experienced during the extended period of 2-lane closure following the truck strike incident on the AHB in Sep-2020 that were initially reviewed in the phase 1 report (tier 1 assessment). Figure 48 below indicates that AHB demands reduced on average by 44,000 vehicles per day compared to the 2019 pre-COVID (P50) baseline during the period when 2-lanes were closed following the truck bridge strike in September 2020 (with around 10,000 vehicles per day re-routing to the alternative route via Upper Harbour Bridge on SH18). However as indicated in Figure 49 and Figure 50, despite this level of demand reduction extensive congestion was still experienced on SH1 in both directions approaching the AHB over 8-10 hours per day, with queue lengths reaching up to 6km heading southbound and 16km heading northbound. Hourly flow profiles indicate the capacity throughput achieved on the bridge during the congested periods varied between 4,800 and 5,000 vehicles per hour (with this being limited by the Temporary Traffic Management layout on each approach).

On this basis it could be estimated that in practice, given the shape of the resulting demand profile across the day, it would likely take a demand reduction of somewhere between 45,000 and 50,000 vehicles per day to avoid all congestion impacts if two lanes on the AHB were removed permanently. This represents between 150% and 167% of the theoretical minimum value based on Figure 46. If it is assumed the same multiplier would be required for the one lane option, this

would mean a reduction of between 16,500 and 18,400 vehicles per day to avoid any congestion impacts for the one lane option under high (P90) demands.

For comparison, the maximum demand reduction used for the tier 2, 2-lane option assessment was 17,000 vehicles, and for the tier 3, 1-Lane option assessment it was 7,000 vehicles.

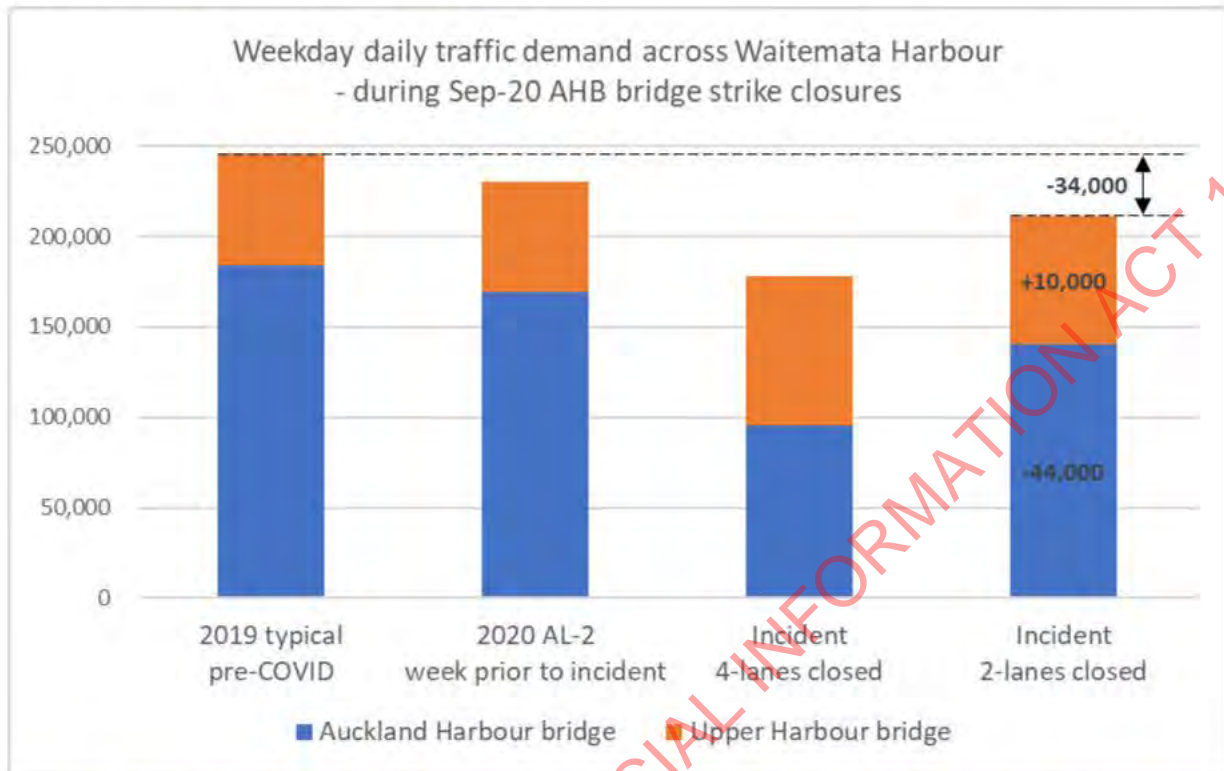

Figure 48 - Daily traffic demand across Waitemata Harbour during Sep-2020 AHB truck strike closures

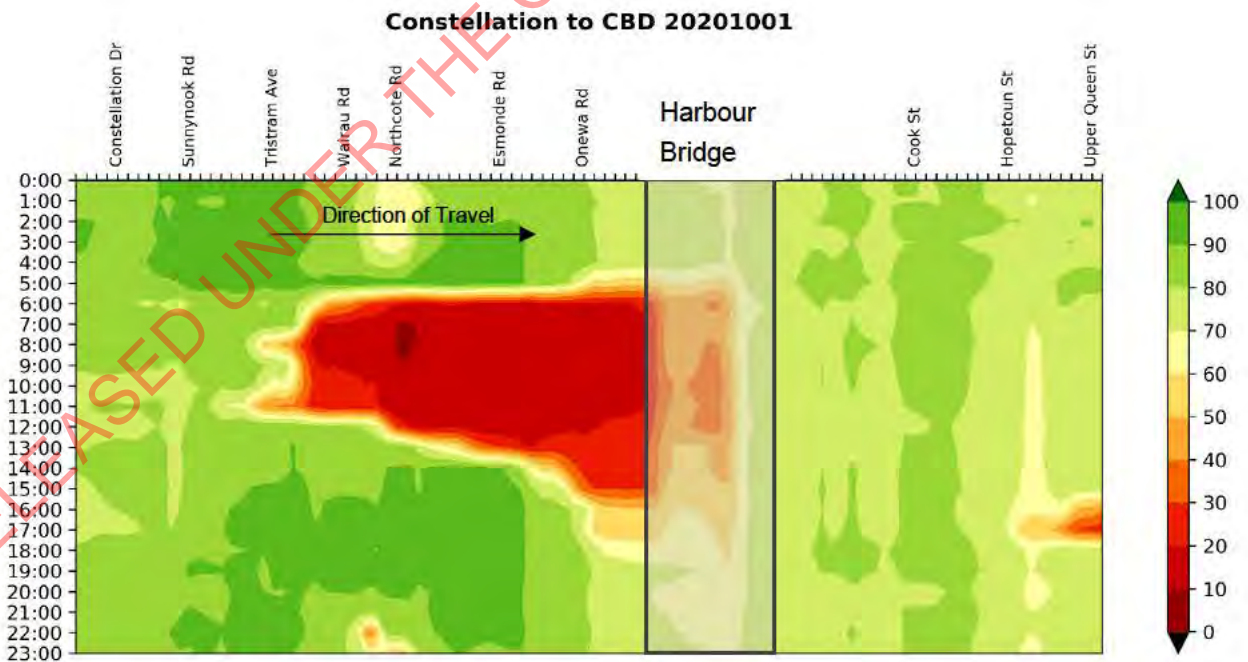

Figure 49 - Sep 2020 truck strike incident SH1 southbound traffic congestion with 2 lanes closed and daily demand reduction of 44,000 vehicles (bidirectional) compared to typical 2019 (pre-COVID) levels

**SH1 NBD Mt Wellington to Onewa Rd 1 Oct 2020**

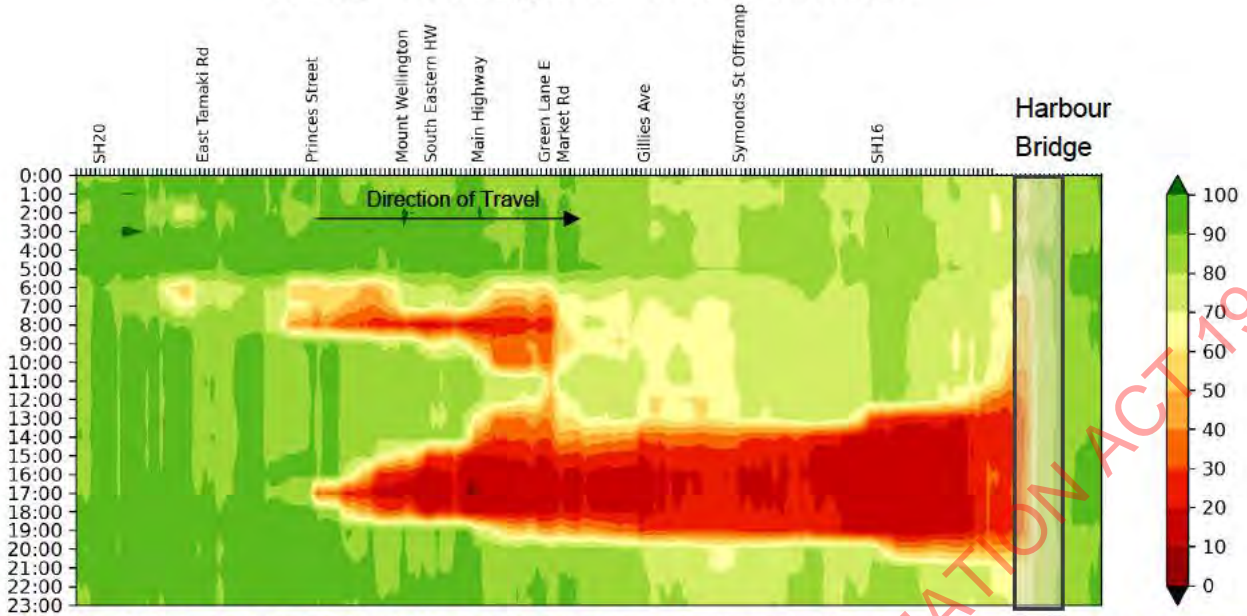

Figure 50 - Sep 2020 truck strike incident SH1 northbound traffic congestion with 2 lanes closed and daily demand reduction of 44,000 vehicles (bidirectional) compared to typical 2019 (pre-COVID) levels

To assess how credible these rough estimates of demand reduction to avoid all congestion impacts are, consider the trend in Annual Average Daily Traffic (AADT) across the AHB since 1990 (Figure 51). The only significant reduction in AADT on the AHB occurred in 2008 - the year following the opening of the Northern Busway. This resulting in a 7.5% reduction in AADT, before it began to rise again the following year (returning to pre-Northern Busway levels seven years later, despite patronage on the Northern Busway almost tripling over the same period). The required reductions in daily AHB demand for no adverse traffic impacts compare to this reduction as follows<sup>9</sup>:

- The 2-Lane option would require equivalent to a 26% reduction in AADT (over three times that achieved by the Northern Busway in its first year, returning the AHB AADT to 1994 levels).
- The 1-Lane option would require equivalent to a 5.4% reduction in AADT (70% of that achieved by the Northern Busway in its first year, returning AHB AADT to 2013 levels).

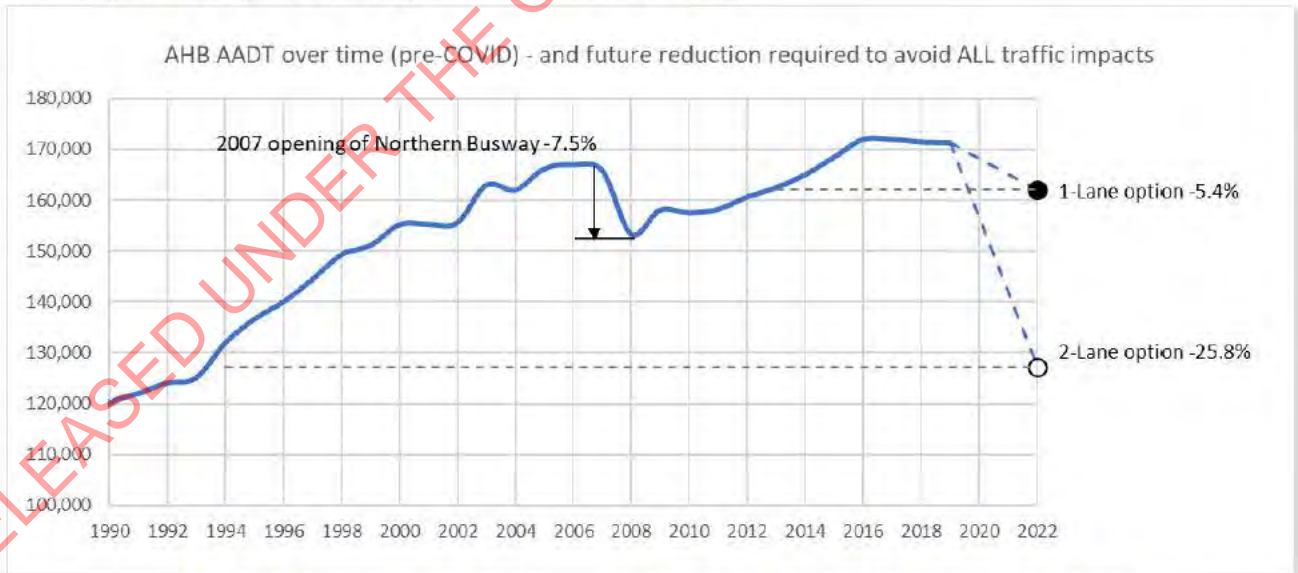

Figure 51 – Minimum reduction in AHB AADT to avoid ALL impacts of proposed options

<sup>9</sup> This assumes that AADT equates to 88% of typical weekday daily volumes (based on 2019 data for the AHB) and using the demand reductions required under P50 2019 base demands – as these would represent the reductions required on average throughout the year to avoid impacts (on higher demand days, higher reductions would be required).

The magnitude of these demand reductions does not seem credible in this context: if provision of a new high-quality rapid transit corridor is required to attract 7.5% of AHB demand away from private vehicle use it seems highly improbable similar levels would be achieved by removal of the 1-Lane of traffic capacity to provide an active mode facility, with no improvement in other alternatives. The active mode facility has been assessed based on the available evidence that in the best-case scenario it is only likely to attract 17% of the required demand reduction for the 1-Lane option (and 6% for the 2-Lane option).

These observations also offer some additional validation of the levels of demand reductions adopted for the tier 2 and tier 3 assessments. It is something of an open question whether additional strong demand management measures such as significant Central City parking supply reduction and/or price increases and congestion charging (post 2025) could reduce demand enough to avoid much of the congestion impacts assessed in tier 2 and tier 3. However, given the practical constraints on the quantity of demand that could switch to other modes this would require a significant amount of permanent cross-harbour trip suppression (against the background of expected continued regional population growth). A glance at Figure 51 indicates that demand suppression of the scale needed to largely avoid additional network congestion for either option would likely impose a heavy impact on the region's economy.

RELEASED UNDER THE OFFICIAL INFORMATION ACT 1982

## 8. CONCLUSIONS

The AHB currently operates largely free of congestion (including during peak periods) as a consequence of upstream “strategic” bottlenecks that throttle the arrival of traffic to the bridge. This current situation aligns well with the Auckland Network Operating Plan the Auckland Motorway Operational Strategy (AMOS) that is currently being developed. A key concern with both options would be the impact on PT services that use the AHB if one or two lanes are reallocated as the AHB itself would consequently become a critical bottleneck in each direction. The upstream bottlenecks currently ensure a good LoS for PT on the AHB and its immediate approaches where buses use general traffic lanes.

Loss of two general traffic lanes would have a severe impact on the operation of the motorway and strategic arterial networks. Even allowing for optimistic behaviour changes assumptions that would remove over 17,000 vehicles per day from the AHB (including more than 2,000 vehicles per hour for three hours in each peak) this would fail to prevent close to a doubling of motorway congestion hours along with a doubling of the total length of on-ramp queues (compared to 2019 conditions). It is an open question whether additional trip suppression would occur to attenuate these impacts, however suppression of sufficient trips to significantly reduce the resulting congestion would itself impose a heavy impact on the region’s economy. Even a reduction of 17,000 vehicles per day would reduce the AADT on the bridge to levels not seen since the year after northern busway opened, 15 years ago.

The impacts of the 1-Lane option appear relatively modest compared to the 2-Lane option but are still significant from a customer perspective. The loss of one lane for one or other direction at all times of day is likely to result in traffic backlogs that build up daily during the middle of the day. Although relatively modest to begin with the resulting backlog on the northern motorway will build rapidly into the afternoon. Active management to mitigate this by delaying the AHB lane switch as late as possible each day would risk the opposing backlog on the southern motorway triggering a cascading impact on traffic conditions on that corridor into and through the PM peak. This situation becomes more unstable on days when traffic demands are high and presents a risk of a major deterioration in network reliability for the busiest road corridor and freight route in New Zealand.

The Western Ring Route alternative route to SH1 via SH18, SH16 and SH20 does not provide its function very effectively. As well as being much longer it suffers from severe capacity constraints in a number of locations (most critically on SH16 westbound and eastbound) and the ramp metering system does not currently manage SH16 inflows effectively. This means at peak times when already congested it does not provide a viable alternative unless congestion on SH1 is extremely bad. When SH1 is extremely congested any re-distribution of traffic to SH16 or SH20 rapidly leads to these corridors also becoming severely congested. The net result of this redistribution of traffic would be to significantly impact overall regional accessibility (see SH20 congestion heatmaps in Appendix E for 2-Lane option). While this would be an issue daily under the 2-Lane option it would also significantly impact network resilience under the 1-Lane option, under circumstances such as a lane blocking incident on the AHB (a situation that occurs once every few weeks).

The loss of resilience associated with the 1-Lane option could be mitigated to some extent through minor improvements for general traffic operation to address key capacity pinch-points and ramp metering (especially on SH16). A number of potential projects to do this have already been submitted by the ASM to the Auckland Optimisation Programme.

The level of traffic demand reduction required to avoid network traffic congestion impacts altogether does not seem credible through mode shift, trip rerouting and re-timing alone based on the required reduction in AHB AADT. Additional demand management measures of a severity necessary to achieve the large-scale permanent suppression (cancellation) of cross-harbour trips needed to avoid these impacts would likely have significant economic consequences for the Auckland region.

## APPENDIX A - TOOLS TO PREDICT TRAFFIC IMPACTS...AND THEIR LIMITATIONS

This is taken from the report of the previous assessment that was carried out in May – June 2021

*“All models are wrong, but some models are useful.”*

The statistician George Box is known for this aphorism – and he goes on to say that the question you should ask is not “is the model true?”, but “is the model good enough to be helpful for a particular application?”

There are a number of available traffic modelling tools that can help to answer the question of what will happen to the excess traffic demand if one or two traffic lanes on the AHB were re-purposed as a cycling and walking facility. However, none of these tools are ideally suited to the job, and none on their own can give a fully robust answer. However, they all provide some help in trying to understand the likely impacts on traffic.

The available modelling tools are:

- Auckland Macro Strategic Model (MSM)
- Auckland Dynamic Traffic Assignment Model (ADTA)
- Northern Corridor Improvements (NCI) SATURN model
- Auckland Motorway Network Cell Transmission Model (CTM)
- AHB Queuing model (AHB-Q)

**The Auckland Macro Strategic Model (MSM)** covers the region’s entire road network and Public Transport system. It is operated by the Auckland Forecasting Centre and its primary role is to understand how major changes to the transport system affect mode choice between private vehicles and public transport, and how private vehicles distribute themselves across the road network. The model evaluates the network in 2-hour blocks of time (there are three 2-hour blocks to cover AM peak, interpeak and PM peak). The representation of the motorway network is coarse, and congestion is represented through delays on individual links and intersections, which is suited to large models used for strategic planning purposes. However, this type of model is not well suited to replicating small-scale operational changes because it does not provide realistic propagation of congestion and queues in a way that realistically affects performance of upstream sections of the network.

**Northern Corridor Improvements (NCI) SATURN** (Simulation and Assignment of Traffic to Urban Road Networks) model. The primary role of this tool is to determine how a fixed amount of traffic routes itself from a series of journey start locations (origins) to series of corresponding end locations (destinations), accounting for delays along the way. In other words, it determines how traffic is distributed across a congested network. By accounting for capacity constraints of a network (primarily at intersections) SATURN incorporates “flow metering” which provides a realistic spread of congestion across a network – including how queues can block flows at upstream intersections. SATURN is normally used to model large areas (thousands of links), although it is capable of analysing the effects of relatively minor network changes. However, it is limited in relation to analysing motorway operation in two ways:

- It was not originally designed to model motorways and as such is limited in how motorway capacity can be represented. Additionally, most effort to calibrate a SATURN model is devoted to operation of intersections on the arterial network (which usually govern the routing of traffic), often leading to the use of “typical” capacities across most motorway links, where in reality individual links may differ considerably from this.
- SATURN is normally used to model the peak hour as a single one-hour block of time, which limits the ability to accurately reflect the growth of congestion spatially across the network. The buildup of queues throughout the peak can be approximated through use of an additional 1-hour “pre-peak” model – which effectively “loads” the network with queues before the peak model is run.

The NCI SATURN model has the added limitation that it only covers the Auckland network north of CMJ and the Waterview Tunnel – SH20 and the Southern Motorway are not included. This means any congestion impacts of modifying the lanes on the AHB on the operation of the southern motorway will not be represented.

**The Auckland Dynamic Traffic Assignment Model (ADTA)** is also operated by the Auckland Forecasting Centre. Dynamic Traffic Assignment models also determine the routing of traffic through and its resulting distribution across a network, but they consider the growth and spreading of congestion over time and space in a more realistic way, using multiple, smaller time periods. However, because of this Dynamic Traffic Assignment Models are extremely complex models - which is compounded when they are used to represent very large networks (the ADTA, like the MSM, covers the entire of Auckland’s road network). They are very difficult to calibrate to observed data, which means that not all parts of large models will respond realistically.



**The Auckland Motorway Cell Transmission Model (CTM).** This tool was designed and built by the AMA Network Performance Team specifically for analysing congested operation of the Auckland motorway network and is now operated by the ASM. The CTM simulates macroscopic traffic behavior on a corridor network by dividing it into short, homogeneous sections (called cells) and calculating traffic behavior in each cell at each discrete time-step using concepts from theories of fluid flow. It has the following strengths:

- It accurately captures the formation, spreading and clearing of congestion in time and space and models an entire 24-hour period in one continuous model, using incremental 10-second time steps.
- It is simple and quick to set up and run compared to traditional models (micro, meso or macro).
- It is easy and quick to run large numbers of scenarios to sensitivity test input assumptions.
- It has been calibrated for all parts of the motorway network and validated against 2018 observed data. It is easy to incrementally improve calibration against continuously collected loop detector data.
- It realistically models the traffic responsive and coordinated operation of ramp signals, including realistic growth of queues waiting at on ramps. The ramp signals within the model have used configuration data from the SCATS Ramp Metering System implemented in Auckland achieve realistic operation.

There are two primary weaknesses of the CTM:

- it only simulates the traffic impact of a given, fixed demand pattern – it does not re-route traffic when congestion delays get high. However, it is quick and easy to incrementally modify demand patterns manually and run multiple scenarios quickly.
- It only covers the motorway network and does not include arterial or local roads and therefore cannot directly simulate the impact on them of changes to the motorway network or its operation. However, through the operation of ramp signals in the model changes in on ramp queues can be used to infer likely impacts on the arterial and local road network. This is limited by the fact that the impact on through traffic on adjoining arterials getting caught up in ramp signal queues that block back onto these routes is not captured. Nevertheless, changes in queuing at the on-ramp, corridor and network level between modelled options is still a useful proxy for relative arterial impacts.

**AHB Queuing model (AHB-Q).** This simple spreadsheet-based queuing model was built by the ASM following the truck strike of the AHB in September 2020, to allow the impact of alternative MLB operations on traffic flows in both direction over the bridge to be assessed rapidly. By using accurate, detailed arrival profiles for the foot of the bridge in each direction under a range of daily demand levels, combined with accurate capacities for each lane configuration, a clear picture of the growth and dissipation of backlogged traffic in either direction can be attained. However, it does not track the progression of queues spatially along the adjoining corridor and cannot account for the interaction of queues with upstream congestion, on / off ramps or adjoining arterials.

Figure 52 provides an overview of the relative strengths and weaknesses of each of these modelling tools. The tools were used in the following ways in the assessment of the options:

- The AMN-CTM was used as the primary tool for evaluating the impact on motorway traffic congestion. The capacity of the options was represented as accurately as possible from the preliminary layout designs available at the time of the assessment. Multiple demand scenarios were tested, with changes in demands comprising the following components.
  - Targeted mode shift (removal of traffic between specific on and off ramps)
  - Re-routing (manual reassignment of traffic away from AHB to SH16/SH18/SH20)
- The MSM was used to guide the magnitude of targeted mode shift to PT. We engaged with AFC who ran several AHB lane reduction scenarios to represent the range of options.
- The MSM and NCI SATURN model were use guide the magnitude of re-routing and the broad entry and exit locations of these trips to/from the motorway. In addition to engaging with AFC, we discussed the NCI SATURN model with Flow Transportation Specialists and conducted several tests with the model.
- The AHB-Q was used as a “common sense” check on the duration of congestion generated in the AMN-CTM at the foot of the bridge in each direction for different options, and to a lesser extent the spatial extent of the resulting congestion.

- It was intended to use ADTA to better understand the potential propagation of congestion onto arterial and local road networks. However, the timeframe was too short for us to agree with AFC what tests to run and for them to prepare and run them in time for inclusion in this report.

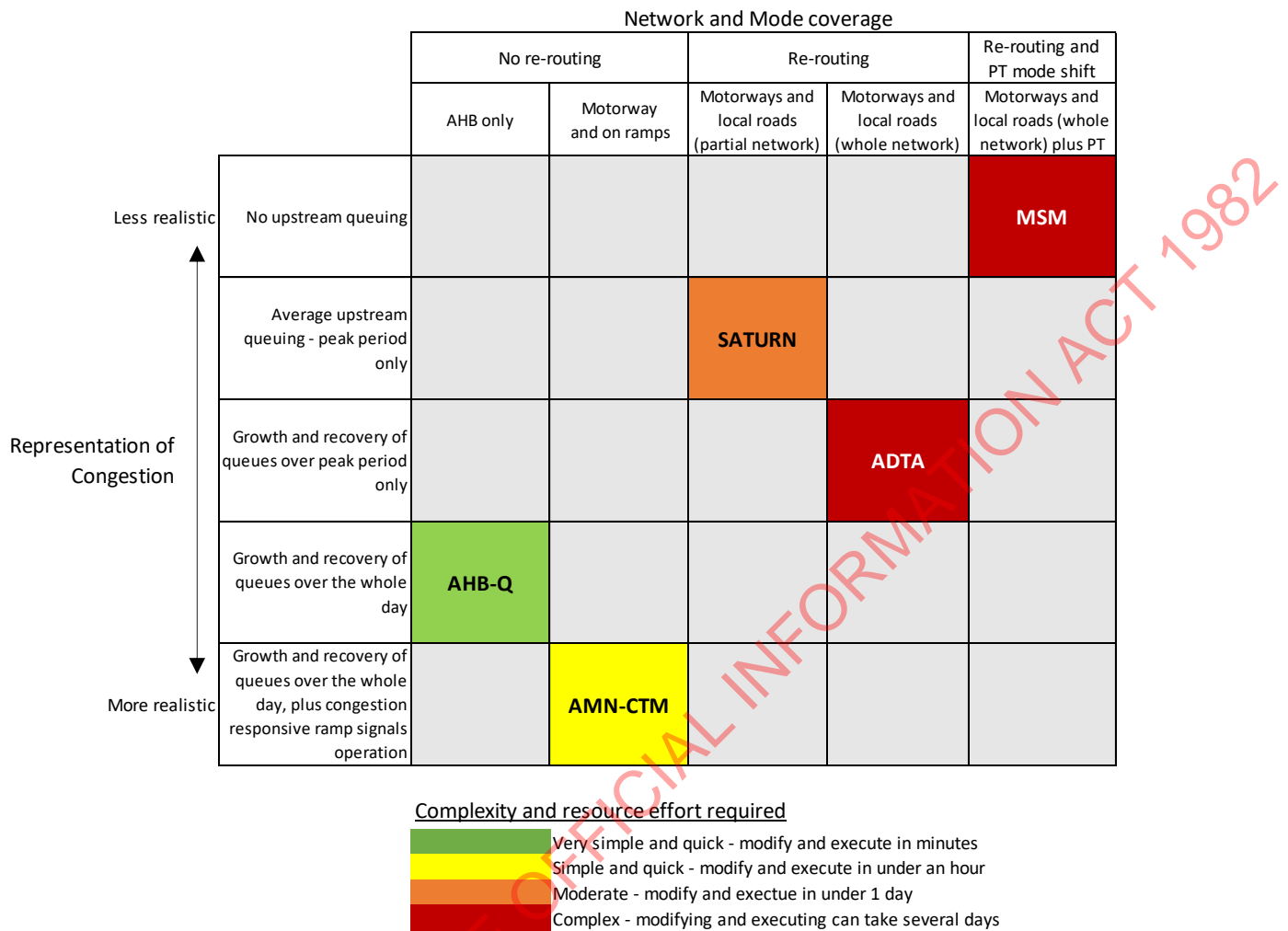

Figure 52 – Summary of strengths and weaknesses of relevant traffic modelling tools available

## APPENDIX B – AHB TRAFFIC DATA SOURCES

There are three loop detector sites that the ASM uses to establish AHB traffic volumes for analysis purposes (see Figure 53 and Figure 54):

1. Classifier site (official TMS count site)
2. SCATS Ramp Metering System (SRMS) loops adjacent to the old toll plaza
3. BlackCat loops – old Odyssey site upgraded with BlackCat detector unit.

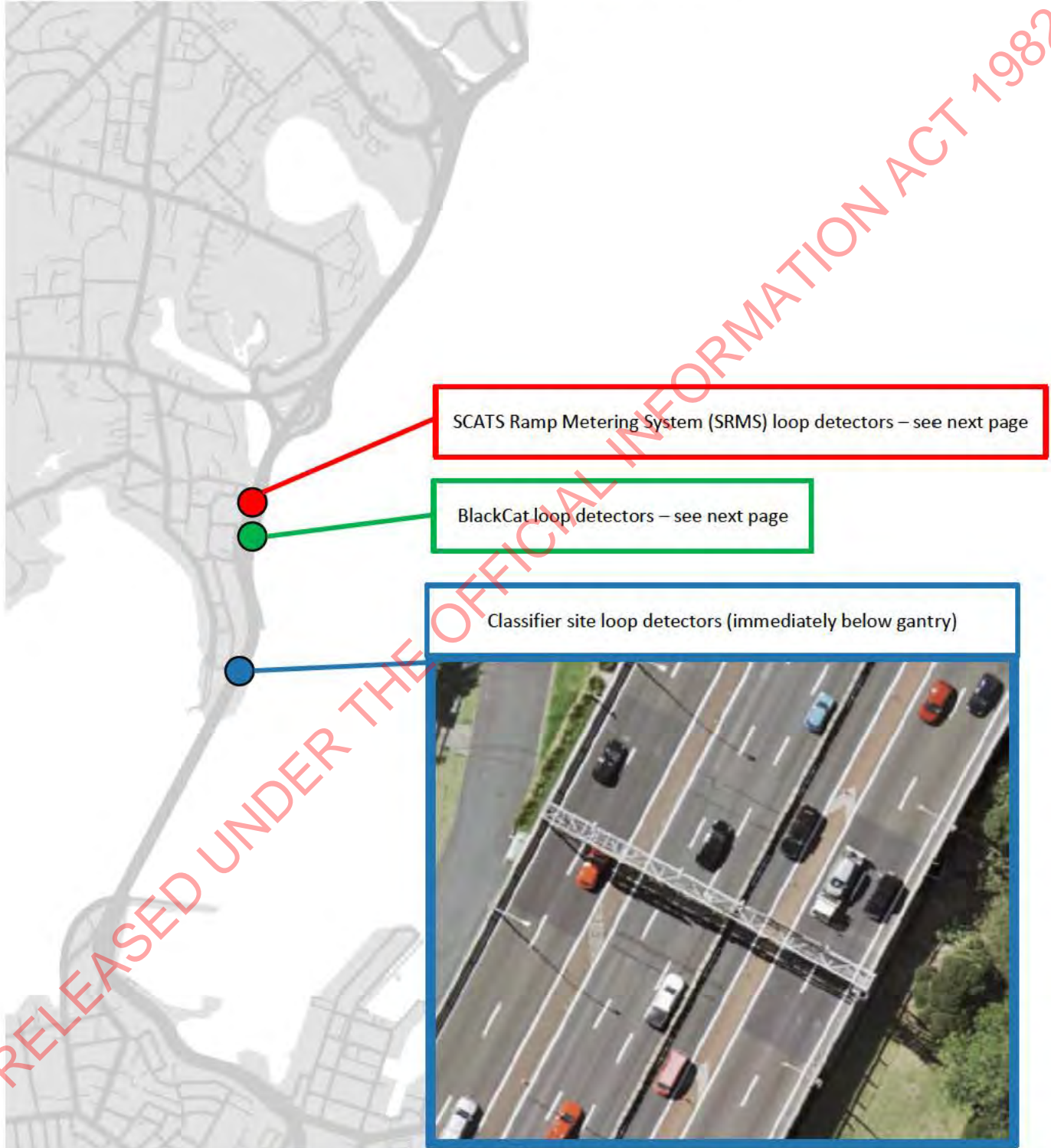

Figure 53 – Location of detectors used to establish AHB volumes



Notes:  
Lanes Lines have now changes with the Bus Shoulder running project

Notes:  
Coloured Loops are SCATS

AS BUILT

1	Initial Issue - Bus Shoulder Running Project	AT	1007/2012	<p><b>NZ TRANSPORT AGENCY</b> WAKA KOTAHI</p>	<p>New Zealand Transport Agency 110 Combas House 101 Queen St Auckland</p>	<p>Conditions of use: This document may only be used by Transport for the purpose of which it was prepared and must not be used by any other person or for any other purpose.</p>	<p>E-4730-N Black Cat Stafford Rd (AHB)</p>	<p>Drawing No: Original Size: A3 Rev: 1</p>
2								
3								



Notes:  
Lanes Lines have now changes with the Bus Shoulder running project

Notes:  
Power from E-472-S 82m away  
Coloured Loops are SCATS



SH1 Stafford Rd NB off ramp

AS BUILT

1	Initial Issue - Bus Shoulder Running Project	AT	1007/2012	<p><b>NZ TRANSPORT AGENCY</b> WAKA KOTAHI</p>	<p>New Zealand Transport Agency 110 Combas House 101 Queen St Auckland</p>	<p>Conditions of use: This document may only be used by Transport for the purpose of which it was prepared and must not be used by any other person or for any other purpose.</p>	<p>E-4730-N Black Cat Stafford Rd (AHB)</p>	<p>Drawing No: Original Size: A3 Rev: 1</p>
2								
3								

Figure 54 – Location for SCATS ramp metering loop detectors and BlackCat loop detectors



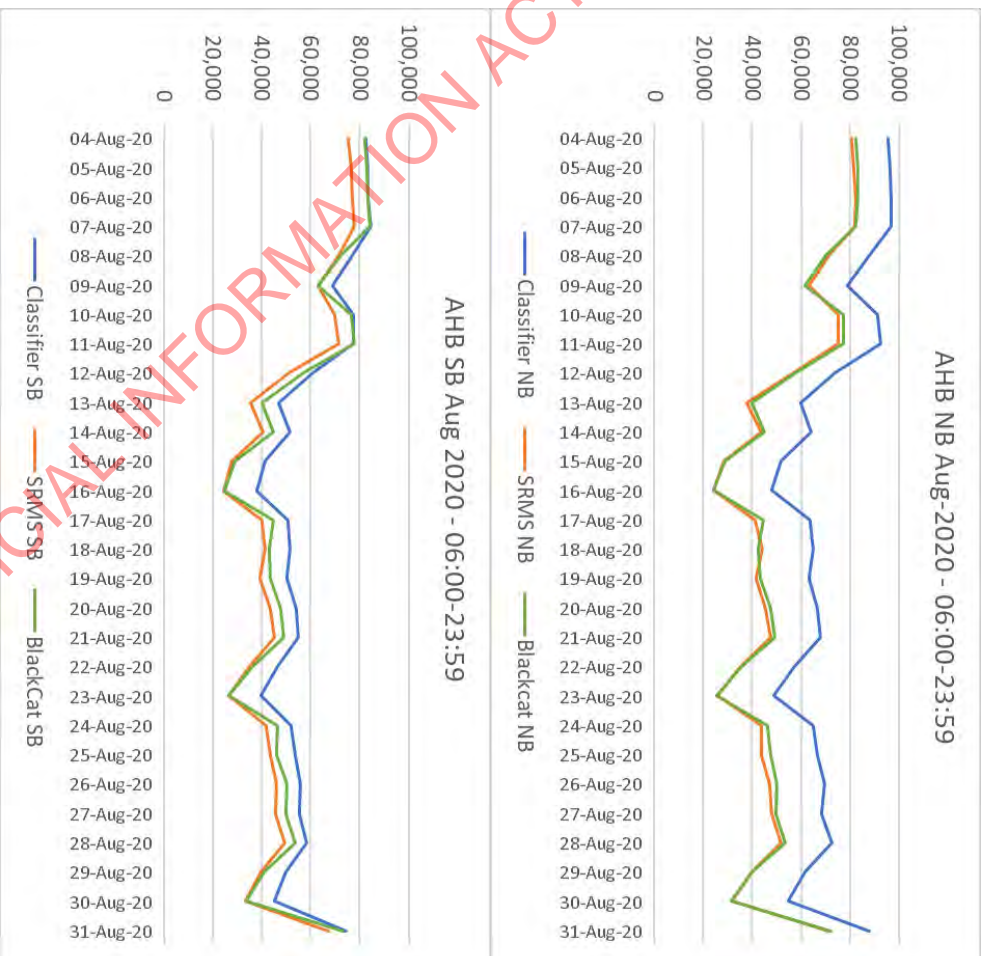

Figure 56 - 18-hour volumes for all three detector sites for August 2020

Given the good continuity of SRMS data over many years a check of AADT generated from SRMS data for the whole year against official AADT figures was carried out for the last 3 available years of data, which showed close agreement between SRMS data and the official AADT figure, especially for pre-COVID-19 (see Table 4).

Table 4 – AHB official AADT estimates and SRMS estimates

Year	Official AADT	SRMS AADT	Difference	% Difference
2018	171,393	171,473	-44	-0.03%
2019	171,300	170,507	793	0.46%
2020	139,477	145,028	-5,551	-3.98%

Note that due to the issues with the Classifier site following the controller upgrade in late December 2018 the following two years official AADT figure was established as follows:

- 2019 - supplementing available valid Classifier site data with data from the official TMS continuous count stations immediately up and downstream at Esmond Road and St Mary's Bay (including standard methods to balance the differences) .
- 2020 – with only 8-9 months of useable Classifier data and extreme variations of flows in both directions the AHB site was treated as a virtual site with AADT generated entirely from adjacent sites: the official TMS continuous count stations immediately upstream at Esmond Road and a different SRMS site south of the AHB in St Mary's Bay (as the St Mary's Bay TMS site itself had 210 days of invalid or missing data).

Based on the continuity of data from the SRMS site and its close agreement with official AADT figures pre-COVID the SRMS site was used for the analysis to establish base demands for 2019. In addition, as data from the same site was also used to establish AHB capacity estimates for the analysis (see Appendix D) this would mean any systematic bias in volume data at the site would be accounted for in the analysis (as the impacts depend on the difference between estimated demands and capacities).

## APPENDIX C – BREAKDOWN OF DEMAND REDUCTIONS USED

RELEASED UNDER THE OFFICIAL INFORMATION ACT 1982





2-Lane Option - Minimum AHB Demand

	AHB Northbound												Simple Q-delay analysis										
	Base AHB Volumes				Demand Changes				Resulting AHB Volumes				AHB Capacity		Queue		Delay (mins)						
	Total vehicle volumes	Proportion from CBD	%HCV	Heavy Vehicles	Light Vehicles from	Active trips	PT-Active transfers	12% WHF	Additional Net Reduced vehicle volumes	Peak Spreading	Net Spread Vehicle Volumes	AHB demand changes for CTM input	Re-routing iterative (from CTM testing)	Net Spread vehicle volumes including re-routing	Change in Vehicle Volumes	% change in Light Vehicles from AHB		% change in total AHB vehicles	Discharge	Queue (veh)	Queue (lane-km)	10	mp per veh
00.00	0.674%	625	68%	42	365	0	0	0	619	0.72%	0.72%	619	-6	619	-6	-1%	-1%	619	0	0.0	0.0	0.0	0.0
01.00	0.436%	404	63%	39	231	0	0	0	400	0.47%	0.47%	400	-4	400	-4	-2%	-1%	400	0	0.0	0.0	0.0	0.0
02.00	0.292%	271	58%	37	135	0	0	0	268	0.31%	0.31%	268	-3	268	-3	-2%	-1%	268	0	0.0	0.0	0.0	0.0
03.00	0.279%	258	47%	48	98	0	0	0	256	0.30%	0.30%	256	-3	256	-3	-3%	-1%	256	0	0.0	0.0	0.0	0.0
04.00	0.422%	391	38%	19	118	0	0	0	387	0.45%	0.45%	387	-4	387	-4	-3%	-1%	387	0	0.0	0.0	0.0	0.0
05.00	1.267%	1173	35%	145	357	0	0	0	1162	1.36%	1.36%	1162	-11	1162	-11	-3%	-1%	1162	0	0.0	0.0	0.0	0.0
06.00	3.196%	3445	23%	77	730	0	0	0	3411	3.98%	3.98%	3411	-34	3411	-34	-5%	-2%	3411	0	0.0	0.0	0.0	0.0
07.00	5.310%	4919	34%	157	1572	0	0	0	4819	5.63%	5.63%	4819	-99	4819	-99	-6%	-2%	4819	0	0.0	0.0	0.0	0.0
08.00	5.277%	4841	45%	198	1987	0	0	0	4743	5.54%	5.54%	4743	-98	4743	-98	-5%	-2%	4743	0	0.0	0.0	0.0	0.0
09.00	5.089%	4677	45%	192	1927	0	0	0	4582	5.35%	5.35%	4582	-95	4582	-95	-5%	-2%	4582	0	0.0	0.0	0.0	0.0
10.00	5.105%	4728	48%	204	1967	0	0	0	4633	5.41%	5.41%	4633	-96	4633	-96	-5%	-2%	4633	0	0.0	0.0	0.0	0.0
11.00	5.492%	5087	45%	211	2110	0	0	0	4984	5.82%	5.82%	4984	-103	4984	-103	-5%	-2%	4984	0	0.0	0.0	0.0	0.0
12.00	5.901%	5465	44%	224	2241	0	0	0	5355	6.25%	6.25%	5355	-111	5355	-111	-5%	-2%	5355	155	15	1.8	1.8	1.8
13.00	6.093%	5644	45%	237	2327	0	0	0	5300	6.46%	6.46%	5300	-114	5300	-114	-5%	-2%	5300	330	48	5.6	5.6	5.6
14.00	6.988%	6445	45%	261	2610	0	0	0	6056	7.07%	7.07%	6056	-116	6056	-116	-5%	-2%	6056	856	134	15.5	15.5	15.5
15.00	7.799%	7223	43%	337	2976	0	0	0	6617	7.73%	7.73%	6617	-167	6617	-167	-11%	-21%	6617	506	184	21.3	21.3	21.3
16.00	8.428%	7807	47%	302	3524	0	0	0	6013	7.02%	7.02%	6013	-162	6013	-162	-10%	-30%	6013	256	210	24.3	24.3	24.3
17.00	8.459%	7835	52%	325	3942	0	0	0	6009	7.07%	7.07%	6009	-171	6009	-171	-10%	-30%	6009	256	236	27.2	27.2	27.2
18.00	7.536%	6980	59%	325	3992	0	0	0	5326	6.22%	6.22%	5326	-172	5326	-172	-10%	-38%	5326	256	261	30.2	30.2	30.2
19.00	5.025%	4654	52%	243	2356	0	0	0	4560	5.33%	5.33%	4560	-94	4560	-94	-13%	-10%	4560	0	0.0	0.0	0.0	0.0
20.00	3.493%	3235	58%	169	1818	0	0	0	3170	3.70%	3.70%	3170	-65	3170	-65	-4%	-2%	3170	0	0.0	0.0	0.0	0.0
21.00	3.141%	2909	59%	167	1675	0	0	0	2881	3.36%	3.36%	2881	-28	2881	-28	-2%	-1%	2881	0	0.0	0.0	0.0	0.0
22.00	2.418%	2239	56%	83	1218	0	0	0	2218	2.59%	2.59%	2218	-22	2218	-22	-2%	-1%	2218	0	0.0	0.0	0.0	0.0
23.00	1.478%	1369	64%	63	839	0	0	0	1355	1.58%	1.58%	1355	-13	1355	-13	-2%	-1%	1355	0	0.0	0.0	0.0	0.0

100% 92.625 5,494 41,216 -1,430 -4,968 429 -2,447 85,612 -7,013 -2,500 83,112 -9,513 -2,3% -10%

	AHB Southbound												Simple Q-delay analysis										
	Base AHB Volumes				Demand Changes				Resulting AHB Volumes				AHB Capacity		Queue		Delay (mins)						
	Total vehicle volumes	Proportion from CBD	%HCV	Heavy Vehicles	Light Vehicles to CBD	Active trips	PT-Active transfers	12% WHF	Additional Net Reduced vehicle volumes	Peak Spreading	Net Spread Vehicle Volumes	AHB demand changes for CTM input	Re-routing iterative (from CTM testing)	Net Spread vehicle volumes including re-routing	Change in Vehicle Volumes	% change in Light Vehicles from AHB		% change in total AHB vehicles	Discharge	Queue (veh)	Queue (lane-km)	10	mp per veh
00.00	0.439%	401	69%	26	259	0	0	0	397	0.47%	0.47%	397	-4	397	-4	-2%	-1%	397	0	0.0	0.0	0.0	0.0
01.00	0.271%	248	47%	15	99	0	0	0	245	0.29%	0.29%	245	-2	245	-2	-2%	-1%	245	0	0.0	0.0	0.0	0.0
02.00	0.244%	195	59%	35	94	0	0	0	193	0.23%	0.23%	193	-2	193	-2	-2%	-1%	193	0	0.0	0.0	0.0	0.0
03.00	0.325%	297	38%	50	95	0	0	0	294	0.35%	0.35%	294	-3	294	-3	-3%	-1%	294	0	0.0	0.0	0.0	0.0
04.00	0.776%	709	49%	81	306	0	0	0	702	0.83%	0.83%	702	-7	702	-7	-2%	-1%	702	0	0.0	0.0	0.0	0.0
05.00	3.629%	3315	49%	154	1555	0	0	0	3282	3.89%	3.89%	3282	-33	3282	-33	-2%	-1%	3282	0	0.0	0.0	0.0	0.0
06.00	7.990%	7300	47%	266	3331	0	0	0	5665	6.71%	6.71%	5665	-88	5665	-88	-4%	-20%	5665	619	6.2	7.1	7.1	7.1
07.00	8.038%	7362	51%	327	3617	0	0	0	5618	6.66%	6.66%	5618	-148	5618	-148	-4%	-20%	5618	619	12.4	14.3	14.3	14.3
08.00	7.513%	7340	54%	375	3668	0	0	0	5600	6.63%	6.63%	5600	-154	5600	-154	-4%	-21%	5600	619	18.6	21.4	21.4	21.4
09.00	8.053%	7404	58%	408	3471	0	0	0	5600	6.89%	6.89%	5600	-145	5600	-145	-4%	-21%	5600	619	24.8	28.6	28.6	28.6
10.00	6.671%	6095	51%	368	2928	0	0	0	5619	6.84%	6.84%	5619	-145	5619	-145	-4%	-15%	5619	619	31.0	35.7	35.7	35.7
11.00	6.201%	5665	53%	394	2777	0	0	0	5545	6.57%	6.57%	5545	-120	5545	-120	-5%	-7%	5545	45	31.4	31.4	31.4	31.4
12.00	6.038%	5498	53%	410	2701	0	0	0	5382	6.38%	6.38%	5382	-116	5382	-116	-5%	-8%	5382	302	30.2	34.9	34.9	34.9
13.00	5.770%	5272	52%	415	2523	0	0	0	5160	6.11%	6.11%	5160	-112	5160	-112	-6%	-8%	5160	0	2.684	26.8	31.0	31.0
14.00	5.753%	5256	51%	396	2499	0	0	0	5145	6.09%	6.09%	5145	-111	5145	-111	-4%	-2%	5145	0	2.628	26.3	30.3	30.3
15.00	5.475%	5001	50%	349	2336	0	0	0	4896	5.80%	5.80%	4896	-106	4896	-106	-5%	-2%	4896	0	2.324	23.2	26.8	26.8
16.00	5.492%	5008	54%	315	2517	0	0	0	4902	5.81%	5.81%	4902	-106	4902	-106	-4%	-2%	4902	0	2.06	20.3	23.4	23.4
17.00	5.399%	4933	55%	256	2590	0	0	0	4828	5.72%	5.72%	4828	-104	4828	-104	-4%	-2%	4828	0	1.654	16.5	19.1	19.1
18.00	4.897%	4474	67%	229	2837	0	0	0	4379	5.19%	5.19%	4379	-95	4379	-95	-3%	-2%	4379	0	833	8.3	9.6	9.6
19.00	3.574%	3265	56%	177	1717	0	0	0	3196	3.79%	3.79%	3196	-69	3196	-69	-4%	-2%	3196	0	0.0	0.0	0.0	0.0
20.00	2.631%	2404	46%	92	1290	0	0	0	2353	2.79%	2.79%	2353	-51	2353	-51	-4%	-2%	2353	0	0.0	0.0	0.0	0.0
21.00	2.297%	2099	46%	91	931	0	0	0	2078	2.46%	2.46%	2078	-21	2078	-21	-2%	-1%	2078	0	0.0	0.0	0.0	0.0
22.00	1.616%	1476	60%	81	843	0	0	0	1461	1.73%	1.73%	1461	-15	1461	-15	-2%	-1%	1461	0	0.0	0.0	0.0	0.0
23.00	0.965%	882	53%	59	439	0	0	0	873	1.03%	1.03%	873	-9	873	-9	-2%	-1%	873	0	0.0	0.0	0.0	0.0

100% 91.359 5,436 45,423 -1,430 -4,978 429 -2,361 84,409 -6,950 -900 83,509 -7,850 -17% -9%

-2,299 -1.2%

1-Lane Option Tier 2 - Maximum AHB Demand

AHB Northbound																				
Base AHB Volumes					Demand Changes					Resulting AHB Volumes					Simple Q-delay analysis					
Total vehicle volumes	Proportion n from CBD	%HCV	Heavy Vehicles	Light Vehicles	Active trips	PT Trips	PT-Active Transfers	Additional WFH	Additional/Net Reduced vehicle volumes	Peak Spreading	Net Spread Vehicle Volumes	Re-routing Iterative changes for CTM	Net Spread vehicle volumes including re-routing	Change in Vehicle Volumes	% change in Light Vehicles from AHB	% change in total vehicles from AHB	Discharge	Queue (veh)	Queue (lane-km)	Delay (mins)
0.5 92,625	0.7 95,365	0.9 97,936	0.5 92,625	0.7 95,365	0.9 97,936	100% 83%	100% 83%	0%	0%	start 14.00	91,476									
0.9 96,207	0.5 91,359							0.0%	0.0%	end 19.00	19,000									
00.00	0.57%	625	63%	42	365	0	-1	0	0	623	0.68%	0.68%	623	-1	0%	0%	623	0	0.0	0.0
01.00	0.436%	404	9.74%	39	231	0	-1	0	0	403	0.44%	0.44%	403	-1	0%	0%	403	0	0.0	0.0
02.00	0.292%	271	58%	37	135	0	-1	0	0	270	0.30%	0.30%	270	-1	0%	0%	270	0	0.0	0.0
03.00	0.279%	258	47%	48	98	0	-1	0	0	258	0.28%	0.28%	258	-1	-1%	0%	258	0	0.0	0.0
04.00	0.422%	391	38%	76	118	0	-1	0	0	390	0.43%	0.43%	390	-1	-1%	0%	390	0	0.0	0.0
05.00	1.267%	1,173	35%	145	357	0	-3	0	0	1,171	1.28%	1.28%	1,171	-2	-1%	0%	1,171	0	0.0	0.0
06.00	3.719%	3,445	23%	268	790	0	-8	0	0	3,438	3.76%	3.76%	3,438	-7	-1%	0%	3,438	0	0.0	0.0
07.00	5.310%	4,919	34%	379	1,172	0	-11	0	0	4,889	5.34%	5.34%	4,889	-9	-1%	0%	4,889	0	0.0	0.0
08.00	5.227%	4,841	45%	411	1,927	0	-11	0	0	4,812	5.26%	5.26%	4,812	-9	-1%	0%	4,812	0	0.0	0.0
09.00	5.049%	4,677	45%	434	1,927	0	-11	0	0	4,649	5.08%	5.08%	4,649	-9	-1%	0%	4,649	0	0.0	0.0
10.00	5.105%	4,728	45%	394	1,967	0	-11	0	0	4,700	5.14%	5.14%	4,700	-8	-1%	0%	4,700	0	0.0	0.0
11.00	5.492%	5,087	45%	413	2,110	0	-12	0	0	5,056	5.53%	5.53%	5,056	-10	-1%	0%	5,056	0	0.2	0.2
12.00	5.903%	5,465	44%	442	2,241	0	-13	0	0	5,433	5.94%	5.94%	5,433	-10	-1%	0%	5,433	0	0.2	0.2
13.00	6.093%	5,644	45%	416	2,327	0	-13	0	0	5,610	6.13%	6.13%	5,610	-10	-1%	0%	5,610	0	0.0	0.0
14.00	6.958%	6,445	45%	381	2,710	0	-15	0	0	6,407	7.00%	7.00%	6,407	-13	-1%	0%	6,407	0	0.0	0.0
15.00	7.795%	7,223	43%	337	2,976	0	-17	0	0	7,180	7.85%	7.85%	7,180	-18	-2%	0%	7,180	0	0.7	0.7
16.00	8.428%	7,807	47%	302	3,524	0	-28	0	0	7,756	8.24%	8.24%	7,756	-21	-2%	0%	7,756	0	1.7	1.5
17.00	8.459%	7,835	3.26%	255	3,942	0	-28	0	0	7,756	8.27%	8.27%	7,756	-21	-2%	0%	7,756	0	2.6	2.2
18.00	7.536%	6,980	59%	3.23%	225	3,992	-48	-25	14	6,739	7.37%	7.37%	6,739	-105	2%	0%	6,739	341	3.4	2.9
19.00	5.025%	4,654	52%	3,53%	164	2,356	-32	-11	10	4,626	5.06%	5.06%	4,626	-28	-1%	0%	4,626	426	4.3	3.7
20.00	3.493%	3,235	58%	3,37%	109	1,818	-22	-8	7	3,216	3.52%	3.52%	3,216	-19	-1%	0%	3,216	0	0.0	0.0
21.00	3.441%	2,909	59%	3,08%	90	1,675	0	-7	0	2,903	3.17%	3.17%	2,903	-6	0%	0%	2,903	0	0.0	0.0
22.00	2.418%	2,239	56%	3,69%	88	1,218	0	-5	0	2,235	2.44%	2.44%	2,235	-4	0%	0%	2,235	0	0.0	0.0
23.00	1.478%	1,369	64%	4,60%	63	839	0	-3	0	1,366	1.49%	1.49%	1,366	-3	0%	0%	1,366	0	0.0	0.0
100%	92,625	5,494	41,216	-550	-994	165	0	91,476	-1,149	91,476	-1,149	0	91,476	-1,149	-3%	-1%	401	0	0.0	0.0

AHB Southbound																				
Base AHB Volumes					Demand Changes					Resulting AHB Volumes					Simple Q-delay analysis					
Total vehicle volumes	Proportion n from CBD	%HCV	Heavy Vehicles	Light Vehicles	Active trips	PT Trips	PT-Active Transfers	Additional WFH	Additional/Net Reduced vehicle volumes	Peak Spreading	Net Spread Vehicle Volumes	Re-routing Iterative changes for CTM	Net Spread vehicle volumes including re-routing	Change in Vehicle Volumes	% change in Light Vehicles from AHB	% change in total vehicles from AHB	Discharge	Queue (veh)	Queue (lane-km)	Delay (mins)
0.5 91,359	0.7 93,166	0.9 96,207	0.5 91,359	0.7 93,166	0.9 96,207	100% 83%	100% 83%	0%	0%	start 06.00	90,208									
0.5 91,359								10.0%	0.0%	end 11.00	11,000									
00.00	0.439%	401	69%	26	259	0	-1	0	0	401	0.44%	0.44%	401	-1	0%	0%	401	0	0.0	0.0
01.00	0.271%	248	47%	15,00%	37	99	0	-1	0	247	0.27%	0.27%	247	-0	0%	0%	247	0	0.0	0.0
02.00	0.214%	195	59%	17,85%	35	94	0	-0	0	195	0.22%	0.22%	195	-0	0%	0%	195	0	0.0	0.0
03.00	0.325%	297	38%	16,96%	50	95	0	-1	0	296	0.33%	0.33%	296	-1	-1%	0%	296	0	0.0	0.0
04.00	0.775%	709	49%	11,39%	81	306	0	-2	0	708	0.78%	0.78%	708	-1	0%	0%	708	0	0.0	0.0
05.00	3.629%	3,315	49%	4,63%	154	1,555	0	-8	0	3,309	3.67%	3.67%	3,309	-7	0%	0%	3,309	0	0.0	0.0
06.00	7.990%	7,300	47%	3,64%	266	3,331	0	-27	0	7,079	7.84%	7.84%	7,079	-21	-2%	0%	7,079	0	0.0	0.0
07.00	8.056%	7,362	51%	4,44%	327	3,617	-54	-27	16	7,099	8.75%	8.75%	7,099	-47	-6%	0%	7,099	0	0.0	0.0
08.00	8.033%	7,340	53%	5,11%	375	3,668	-54	-27	16	7,078	7.87%	7.87%	7,078	-47	-6%	0%	7,078	0	0.0	0.0
09.00	7.513%	6,864	54%	5,95%	408	3,471	-51	-16	15	6,821	7.56%	7.56%	6,821	-39	-1%	0%	6,821	0	0.0	0.0
10.00	6.671%	6,095	51%	6,36%	388	2,928	-45	-15	14	6,056	6.71%	6.71%	6,056	-36	-1%	0%	6,056	0	0.0	0.0
11.00	6.201%	5,665	53%	6,96%	394	2,777	-42	-14	13	5,630	6.24%	6.24%	5,630	-36	-1%	0%	5,630	0	0.0	0.0
12.00	6.018%	5,498	53%	7,46%	410	2,701	-41	-13	12	5,463	6.06%	6.06%	5,463	-35	-1%	0%	5,463	0	0.0	0.0
13.00	5.770%	5,272	53%	7,88%	415	2,523	-39	-13	12	5,239	5.81%	5.81%	5,239	-33	-1%	0%	5,239	0	0.0	0.0
14.00	5.753%	5,256	51%	7,54%	396	2,499	-39	-13	12	5,223	5.79%	5.79%	5,223	-33	-1%	0%	5,223	0	0.0	0.0
15.00	5.475%	5,001	50%	6,97%	349	2,336	-37	-12	11	4,970	5.51%	5.51%	4,970	-32	-1%	0%	4,970	0	0.0	0.0
16.00	5.482%	5,008	54%	6,28%	315	2,517	-37	-12	11	4,976	5.52%	5.52%	4,976	-32	-1%	0%	4,976	0	0.0	0.0
17.00	6.018%	5,498	53%	5,20%	256	2,990	-36	-11	10	4,902	5.43%	5.43%	4,902	-31	-1%	0%	4,902	0	0.0	0.0
18.00	4.897%	4,474	67%	5,11%	229	2,837	-33	-11	10	4,445	4.93%	4.93%	4,445	-28	-1%	0%	4,445	0	0.0	0.0
19.00	3.574%	3,265	56%	5,41%	177	1,717	-24	-8	7	3,245	3.60%	3.60%	3,245	-21	-1%	0%	3,245	0	0.0	0.0
20.00	2.631%	2,404	56%	4,87%	117	1,290	-18	-6	5	2,389	2.65%	2.65%	2,389	-15	-1%	0%	2,389	0	0.0	0.0
21.00	2.297%	2,099	46%	4,36%	92	931	0	-5	0	2,095	2.32%	2.32%	2,095	-4	0%	0%	2,095	0	0.0	0.0
22.00	1.616%	1,476	60%	5,49%	81	843	0	-4	0	1,473	1.63%	1.63%	1,473	-3	0%	0%	1,473	0	0.0	0.0
23.00	0.965%	882	53%	6,64%	59	439	0	-2	0	880	0.98%	0.98%	880	-2	0%	0%	880	0	0.0	0.0
100%	91,359	5,436	45,423	-550	-996	165	0	90,208	-1,151	90,208	-1,151	0	90,208	-1,151	-3%	-1%	401	0	0.0	0.0



-6.934 -3.6%

1-Lane Option - Tier 3 90 percentile AHB Demand

Time	Base AHB Volumes										Demand Changes										Resulting AHB Volumes										AHB Capacity					Simple O-delay analysis																																																																																																																																																																																																																																																																																																																																																																																																																																																																																																																																																																																																																																																																																																																																																																																																																																																																																																																																																																																																																																																																																																																																																																																																																																				
	Total vehicle volumes		Proportion in %HCV from CBD		Heavy Vehicles from		Light Vehicles from		Active Trips		PT-Active transfers		Additional Net Reduced vehicle volumes		Peak Spreading		Net Spread Vehicle Volumes		Re-routing (from iterative CTM testing)		Net Spread vehicle volumes including re-routing		Change in Vehicle Volumes		% change in Light Vehicles from AHB		% change in total vehicles		Queue (lane-km)		Delay (mins)																																																																																																																																																																																																																																																																																																																																																																																																																																																																																																																																																																																																																																																																																																																																																																																																																																																																																																																																																																																																																																																																																																																																																																																																																																									
	0.5	0.7	0.9	1.2	1.5	1.8	2.1	2.4	2.7	3.0	3.3	3.6	3.9	4.2	4.5	4.8	5.1	5.4	5.7	6.0	6.3	6.6	6.9	7.2	7.5	7.8	8.1	8.4	8.7	9.0	9.3	9.6	9.9	10.2	10.5	10.8	11.1	11.4	11.7	12.0	12.3	12.6	12.9	13.2	13.5	13.8	14.1	14.4	14.7	15.0	15.3	15.6	15.9	16.2	16.5	16.8	17.1	17.4	17.7	18.0	18.3	18.6	18.9	19.2	19.5	19.8	20.1	20.4	20.7	21.0	21.3	21.6	21.9	22.2	22.5	22.8	23.1	23.4	23.7	24.0	24.3	24.6	24.9	25.2	25.5	25.8	26.1	26.4	26.7	27.0	27.3	27.6	27.9	28.2	28.5	28.8	29.1	29.4	29.7	30.0	30.3	30.6	30.9	31.2	31.5	31.8	32.1	32.4	32.7	33.0	33.3	33.6	33.9	34.2	34.5	34.8	35.1	35.4	35.7	36.0	36.3	36.6	36.9	37.2	37.5	37.8	38.1	38.4	38.7	39.0	39.3	39.6	39.9	40.2	40.5	40.8	41.1	41.4	41.7	42.0	42.3	42.6	42.9	43.2	43.5	43.8	44.1	44.4	44.7	45.0	45.3	45.6	45.9	46.2	46.5	46.8	47.1	47.4	47.7	48.0	48.3	48.6	48.9	49.2	49.5	49.8	50.1	50.4	50.7	51.0	51.3	51.6	51.9	52.2	52.5	52.8	53.1	53.4	53.7	54.0	54.3	54.6	54.9	55.2	55.5	55.8	56.1	56.4	56.7	57.0	57.3	57.6	57.9	58.2	58.5	58.8	59.1	59.4	59.7	60.0	60.3	60.6	60.9	61.2	61.5	61.8	62.1	62.4	62.7	63.0	63.3	63.6	63.9	64.2	64.5	64.8	65.1	65.4	65.7	66.0	66.3	66.6	66.9	67.2	67.5	67.8	68.1	68.4	68.7	69.0	69.3	69.6	69.9	70.2	70.5	70.8	71.1	71.4	71.7	72.0	72.3	72.6	72.9	73.2	73.5	73.8	74.1	74.4	74.7	75.0	75.3	75.6	75.9	76.2	76.5	76.8	77.1	77.4	77.7	78.0	78.3	78.6	78.9	79.2	79.5	79.8	80.1	80.4	80.7	81.0	81.3	81.6	81.9	82.2	82.5	82.8	83.1	83.4	83.7	84.0	84.3	84.6	84.9	85.2	85.5	85.8	86.1	86.4	86.7	87.0	87.3	87.6	87.9	88.2	88.5	88.8	89.1	89.4	89.7	90.0	90.3	90.6	90.9	91.2	91.5	91.8	92.1	92.4	92.7	93.0	93.3	93.6	93.9	94.2	94.5	94.8	95.1	95.4	95.7	96.0	96.3	96.6	96.9	97.2	97.5	97.8	98.1	98.4	98.7	99.0	99.3	99.6	99.9	100.2	100.5	100.8	101.1	101.4	101.7	102.0	102.3	102.6	102.9	103.2	103.5	103.8	104.1	104.4	104.7	105.0	105.3	105.6	105.9	106.2	106.5	106.8	107.1	107.4	107.7	108.0	108.3	108.6	108.9	109.2	109.5	109.8	110.1	110.4	110.7	111.0	111.3	111.6	111.9	112.2	112.5	112.8	113.1	113.4	113.7	114.0	114.3	114.6	114.9	115.2	115.5	115.8	116.1	116.4	116.7	117.0	117.3	117.6	117.9	118.2	118.5	118.8	119.1	119.4	119.7	120.0	120.3	120.6	120.9	121.2	121.5	121.8	122.1	122.4	122.7	123.0	123.3	123.6	123.9	124.2	124.5	124.8	125.1	125.4	125.7	126.0	126.3	126.6	126.9	127.2	127.5	127.8	128.1	128.4	128.7	129.0	129.3	129.6	129.9	130.2	130.5	130.8	131.1	131.4	131.7	132.0	132.3	132.6	132.9	133.2	133.5	133.8	134.1	134.4	134.7	135.0	135.3	135.6	135.9	136.2	136.5	136.8	137.1	137.4	137.7	138.0	138.3	138.6	138.9	139.2	139.5	139.8	140.1	140.4	140.7	141.0	141.3	141.6	141.9	142.2	142.5	142.8	143.1	143.4	143.7	144.0	144.3	144.6	144.9	145.2	145.5	145.8	146.1	146.4	146.7	147.0	147.3	147.6	147.9	148.2	148.5	148.8	149.1	149.4	149.7	150.0	150.3	150.6	150.9	151.2	151.5	151.8	152.1	152.4	152.7	153.0	153.3	153.6	153.9	154.2	154.5	154.8	155.1	155.4	155.7	156.0	156.3	156.6	156.9	157.2	157.5	157.8	158.1	158.4	158.7	159.0	159.3	159.6	159.9	160.2	160.5	160.8	161.1	161.4	161.7	162.0	162.3	162.6	162.9	163.2	163.5	163.8	164.1	164.4	164.7	165.0	165.3	165.6	165.9	166.2	166.5	166.8	167.1	167.4	167.7	168.0	168.3	168.6	168.9	169.2	169.5	169.8	170.1	170.4	170.7	171.0	171.3	171.6	171.9	172.2	172.5	172.8	173.1	173.4	173.7	174.0	174.3	174.6	174.9	175.2	175.5	175.8	176.1	176.4	176.7	177.0	177.3	177.6	177.9	178.2	178.5	178.8	179.1	179.4	179.7	180.0	180.3	180.6	180.9	181.2	181.5	181.8	182.1	182.4	182.7	183.0	183.3	183.6	183.9	184.2	184.5	184.8	185.1	185.4	185.7	186.0	186.3	186.6	186.9	187.2	187.5	187.8	188.1	188.4	188.7	189.0	189.3	189.6	189.9	190.2	190.5	190.8	191.1	191.4	191.7	192.0	192.3	192.6	192.9	193.2	193.5	193.8	194.1	194.4	194.7	195.0	195.3	195.6	195.9	196.2	196.5	196.8	197.1	197.4	197.7	198.0	198.3	198.6	198.9	199.2	199.5	199.8	200.1	200.4	200.7	201.0	201.3	201.6	201.9	202.2	202.5	202.8	203.1	203.4	203.7	204.0	204.3	204.6	204.9	205.2	205.5	205.8	206.1	206.4	206.7	207.0	207.3	207.6	207.9	208.2	208.5	208.8	209.1	209.4	209.7	210.0	210.3	210.6	210.9	211.2	211.5	211.8	212.1	212.4	212.7	213.0	213.3	213.6	213.9	214.2	214.5	214.8	215.1	215.4	215.7	216.0	216.3	216.6	216.9	217.2	217.5	217.8	218.1	218.4	218.7	219.0	219.3	219.6	219.9	220.2	220.5	220.8	221.1	221.4	221.7	222.0	222.3	222.6	222.9	223.2	223.5	223.8	224.1	224.4	224.7	225.0	225.3	225.6	225.9	226.2	226.5	226.8	227.1	227.4	227.7	228.0	228.3	228.6	228.9	229.2	229.5	229.8	230.1	230.4	230.7	231.0	231.3	231.6	231.9	232.2	232.5	232.8	233.1	233.4	233.7	234.0	234.3	234.6	234.9	235.2	235.5	235.8	236.1	236.4	236.7	237.0	237.3	237.6	237.9	238.2	238.5	238.8	239.1	239.4	239.7	240.0	240.3	240.6	240.9	241.2	241.5	241.8	242.1	242.4	242.7	243.0	243.3	243.6	243.9	244.2	244.5	244.8	245.1	245.4	245.7	246.0	246.3	246.6	246.9	247.2	247.5	247.8	248.1	248.4	248.7	249.0	249.3	249.6	249.9	250.2	250.5	250.8	251.1	251.4	251.7	252.0	252.3	252.6	252.9	253.2	253.5	253.8	254.1	254.4	254.7	255.0	255.3	255.6	255.9	256.2	256.5	256.8	257.1	257.4	257.7	258.0	258.3	258.6	258.9	259.2	259.5	259.8	260.1	260.4	260.7	261.0	261.3	261.6	261.9	262.2	262.5	262.8	263.1	263.4	263.7	264.0	264.3	264.6	264.9	265.2	265.5	265.8	266.1	266.4	266.7	267.0	267.3	267.6	267.9	268.2	268.5	268.8	269.1	269.4	269.7	270.0	270.3	270.6	270.9	271.2	271.5	271.8	272.1	272.4	272.7	273.0	273.3	273.6	273.9	274.2	274.5	274.8	275.1	275.4	275.7	276.0	276.3	276.6	276.9	277.2	277.5	277.8	278.1	278.4	278.7	279.0	279.3	279.6	279.9	280.2	280.5	280.8	281.1	281.4	281.7	282.0	282.3	282.6	282.9	283.2	283.5	283.8	284.1	284.4	284.7	285.0	285.3	285.6	285.9	286.2	286.5	286.8	287.1	287.4	287.7	288.0	288.3	288.6	288.9	289.2	289.5	289.8	290.1	290.4	290.7	291.0	291.3	291.6	291.9	292.2	292.5	292.8	293.1	293.4	293.7	294.0	294.3	294.6	294.9	295.2	295.5	295.8	296.1	296.4	296.7	297.0	297.3	297.6	297.9	298.2	298.5	298.8	299.1	299.4	299.7	300.0	300.3	300.6	300.9	301.2	301.5	301.8	302.1	302.4	302.7	303.0	303.3	303.6	303.9	304.2	304.5	304.8	305.1	305.4	305.7	306.0	306.3	306.6	306.9	307.2	307.5	307.8	308.1	308.4	308.7	309.0	309.3	309.6	309.9	310.2	310.5	310.8	311.1	311.4	311.7	312.0	312.3	312.6	312.9	313.2	313.5	313.8	314.1	314.4	314.7	315.0	315.3	315.6	315.9	316.2	316.5	316.8	317.1	317.4	317.7	318.0	318.3	318.6	318.9	319.2	319.5	319.8	320.1	320.4	320.7	321.0	321.3	321.6	321.9	322.2	322.5	322.8	323.1	323.4	323.7	324.0	324.3	324.6	324.9	325.2	325.5	325.8	326.1	326.4	326.7	327.0	327.3	327.6	327.9	328.2	328.5	328.8	329.1	329.4	329.7	330.0	330.3	330.6	330.9	331.2	331.5	331.8	332.1	332.4	332.7	333.0	333.3	333.6	333.9	334.2	334.5	334.8	335.1	335.4	335.7	336.0	336.3	336.6	336.9	337.2	337.5	337.8	338.1	338.4	338.7	339.0	339.3	339.6	339.9	340.2	340.5	340.8	341.1	341.4	341.7	342.0	342.3	342.6	342.9	343.2	343.5	343.8	344.1	344.4	344.7	345.0	345.3	345.6	345.9	346.2	346.5	346.8	347.1	347.4	347.7	348.0	348.3	348.6	348.9	349.2	349.5	349.8	350.1	350.4	350.7	351.0	351.3	351.6	351.9	352.2	352.5	352.8	353.1	353.4	353.7	354.0	354.3	354.6	354.9	355.2	355.5	355.8	356.1	356.4	356.7	357.0	357.3	357.6	357.9	358.2	358.5	358.8	359.1	359.4	359.7	360.0	360.3	360.6	360.9	361.2	361.5	361.8	362.1	362.4	362.7	363.0	363.3	363.6	363.9	364.2	364.5	364.8	365.1	365.4	365.7	366.0	366.3	366.6	366.9	367.2

## APPENDIX D – THE DEFINITION AND MEASUREMENT OF TRAFFIC CAPACITY

There are three important features of motorway traffic capacity:

1. Capacity has a “dual nature”: the capacity prior to flow breakdown is higher than the capacity after flow breakdown (see Panel 1 and Figure 57 below)
2. Capacity is not a constant value but varies stochastically leading to a distribution of values (see Panel 2). This applies to both pre-breakdown and post-breakdown capacity (see Figure 58).
3. Capacity can only be directly observed at locations that are active bottlenecks – where demand levels cause flow breakdown to occur while traffic is free-flowing and unimpeded downstream.

### Panel 1: Motorway capacity - flow breakdown and capacity drop

#### 1. Motorway flowing at capacity

The motorway is running “full” - slightly slower than free flow speed with minimal gaps.

Average headway 1.8 seconds = 2,000 vehicles per hour per lane



#### 2. Minor disturbance causes flow breakdown

A lane changing manoeuvre in heavy traffic causes the vehicles behind to brake slightly. Vehicles further behind are forced to brake progressively more, until traffic several hundred metres back comes to a standstill, and a backlog of queuing vehicles begins to form.



#### 3. Queues grow as capacity drops

As vehicles pull away from the front of the queue variations in acceleration due to differing capabilities of vehicles and differing driver behaviour leads to the average gap being greater than when the traffic is flowing, reducing the flow rate to less than it was before. **This is known as Congested Capacity Drop and means that the motorway performs worst when needed the most.** If traffic continues to arrive at the back of the queue faster than it is discharging from the front, the queue grows backwards rapidly along the motorway, like a series of dominos falling. This congestion will only clear when the traffic arriving at the back of the queue reduces to less than the discharge rate at the front of the queue. At peak times on an unmanaged motorway this can take several hours.

Average headway 2.0 seconds = 1,800 vehicles per hour per lane



#### 4. Motorways can “absorb” disturbances when flows are lower (and gaps are larger)

At times when the motorway is not running “full” the gaps between cars are larger – allowing the flow disturbance caused by lane changing and/or braking to be more easily absorbed. The larger gaps act as “buffers”, allowing cars to compress and temporarily get closer without progressively harder braking and without much (if any) loss of speed. This is like dominos being so far apart that a cascade is avoided when one falls.

Average headway 3.6 seconds = 1,000 vehicles per hour per lane

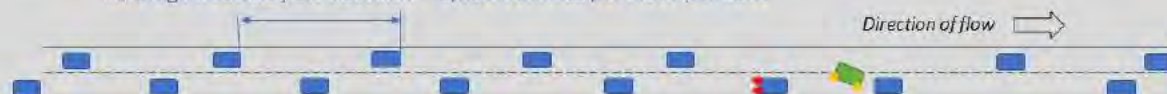

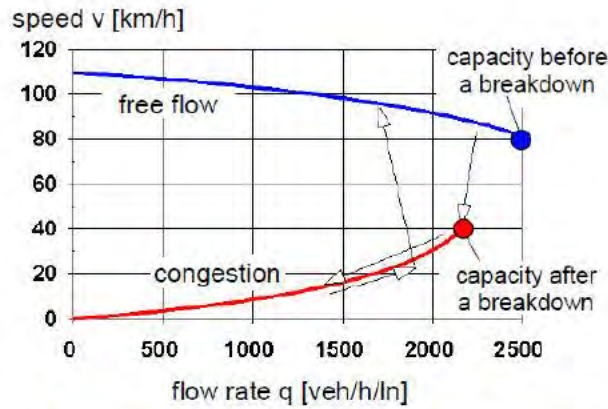
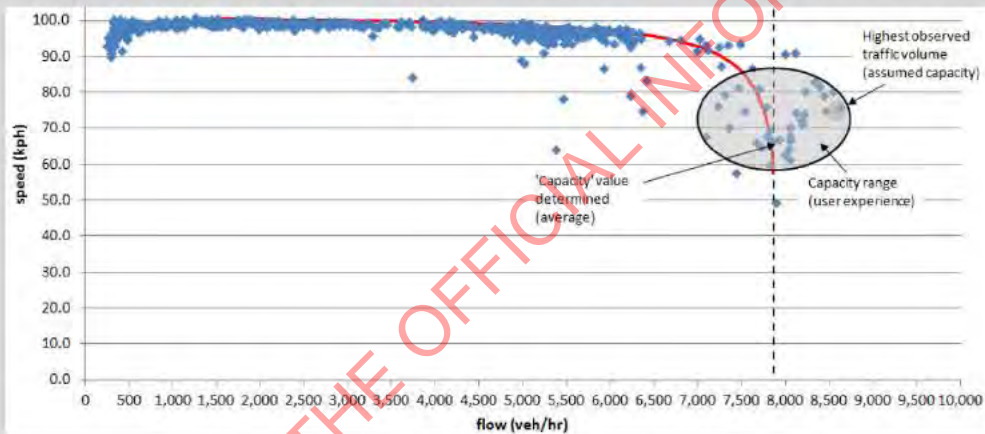

Figure 57 – Dual nature of motorway capacity (Wu 2004)

**Panel 2: Motorway capacity is not a fixed value**

The traditional approach to determining 'capacity' is to fit a curve to a point cloud representing individual speed-flow measurements. Capacity is then defined as the highest flow rate of that curve. The problem of randomly selected high traffic volumes ('assumed capacity') versus an appropriate representation of all points in the relevant area ('average') is illustrated above for a 4-lane motorway (source: Gaffney et al. 2019). It needs to be understood that the speed-flow combinations in the 'capacity range' are widely spread and need to be interpreted in a meaningful way.



The concept of stochastic capacity is based on observations of the demand flow that results in flow breakdown at a bottleneck location. Numerous studies have indicated that the demand volume that causes breakdown is not a constant value and varies in real traffic flow and that the flow rate of a breakdown depends on the behaviour of several factors combined with the specific local configuration of the motorway (see Brilon et. al. 2005).

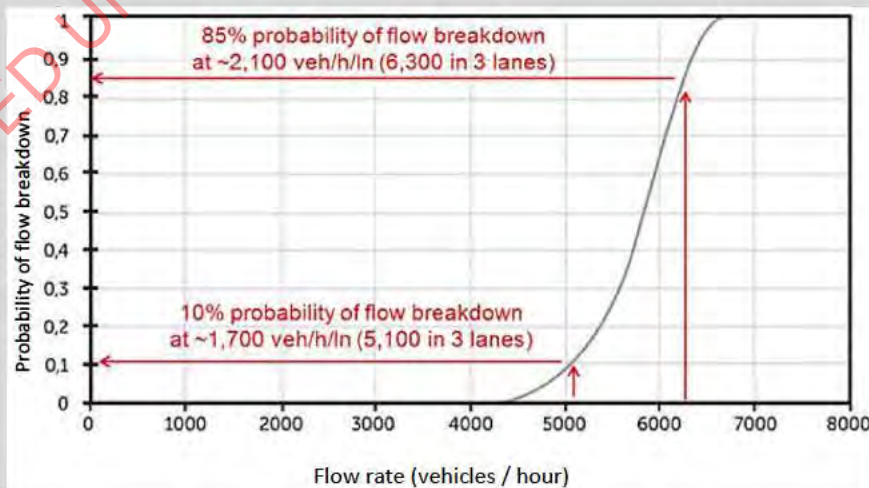

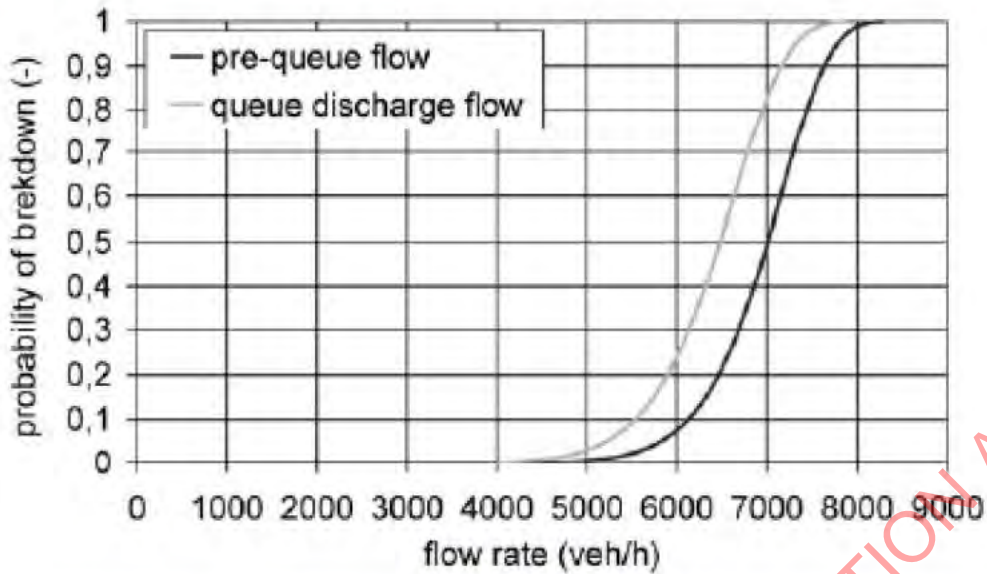

Figure 58 – Capacity distributions for pre flow breakdown (pre-queue flow) and post flow breakdown (queue discharge flow). From Brillon et al. 2005

All three of these features are important when trying to establish the current capacity of the AHB.

Due to upstream bottlenecks limiting traffic arrival rates at the bridge capacity flow rates are not observed when the bridge is in a 4-lane or 5-lane configuration (notwithstanding rare situations such as illustrated in Figure 36 when the AHB remained in 4/4 configuration as the late 2021 COVID lockdown was eased, and demand levels rose day-by-day).

When the AHB is in 3-lane configuration however peak traffic arrival rates in that direction do exceed capacity leading to observable flow breakdown events daily, allowing a quantitative stochastic assessment of capacity.

The concept of stochastic capacity employs ideas from reliability engineering, with breakdown of traffic flow into congested conditions being considered a “failure” of a localised section of motorway to process traffic demand efficiently analogous to the failure of a component in an electrical or mechanical system.

If motorway traffic-flow breakdown is regarded as a failure event, methods for lifetime data analysis can be used to estimate the capacity (C), which is analogous to component lifetime (T). Plotting the cumulative distribution of flow-rates immediately preceding each flow breakdown event characterised by bottleneck behaviour at the measurement location should thus give an estimate of the expected local capacity based on the 50<sup>th</sup> percentile value, see Figure 59.

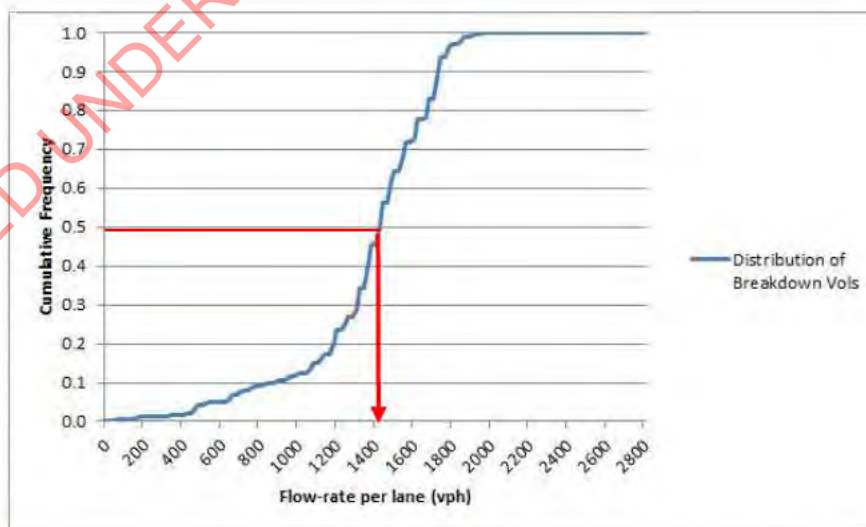

Figure 59 – Cumulative frequency Curve of Flow-rates Immediately Preceding Flow Breakdown

However, this approach ignores the large proportion of flow-rate values that are not immediately followed by flow breakdown – thus much of the available data is ignored. As a result, the capacity of the motorway at this point is substantially underestimated. This is because all flow-rate values **not** followed by a flow breakdown imply that the capacity at that point in time was greater than that measured flow. The greater the number of non-breakdown flow values that exceed a given breakdown flow value, then the more the significance of that flow breakdown value diminishes.

Ideas from reliability engineering and studies from lifetime analysis can assist here. Component lifetime analysis employed in reliability engineering uses distributions for Mean Time Before Failure (MTBF) based on experiments of limited duration. Therefore, a similar situation to traffic flow breakdown arises, where the lifetime of numerous individual components in the sample exceed the duration of the experiment and cannot be measured. It is only possible to state that the lifetimes of these components are longer than the duration of the experiment. This “censored data” can be used to improve the estimate of expected lifetime (or motorway capacity) through use of statistical methods originally employed in studies which examined human lifespan data (Minderhoud et. al. 1998).

Table 5 is adapted from Brilon et al. 2005 and provides a direct analogy between lifetime analysis and motorway traffic capacity analysis.

Table 5 – Analogy Between Lifetime Data Analysis and Traffic Capacity Analysis (Adapted from Brilon et. al. 2005)

	Analysis of Lifetime Data	Motorway Capacity Analysis
<b>Parameter</b>	Time, t	Traffic Volume, q
<b>Failure Event</b>	Death at time t	Flow breakdown at q
<b>Lifetime variable</b>	Lifetime, T	Capacity, C
<b>Censoring</b>	T is longer than study period	C is greater than traffic demand
<b>Survival Function</b>	$S(t) = 1 - F(t)$	$S_c(q) = 1 - F_c(q)$
<b>Probability density function</b>	f(t)	f <sub>c</sub> (q)
<b>Probability distribution function</b>	F(t)	F <sub>c</sub> (q)

The Product Limit Method (PLM) is a statistical technique that utilises the value of censored data to improve lifetime estimates or in this case capacity estimates (Minderhoud et. al. 1998). Without entering into a detailed technical description of the PLM, essentially it generates a survival function which weights the importance of each failure value according to how many recorded non-failure values exceed it. This survival function will be shifted to the right of the cumulative breakdown function as shown in Figure 60.

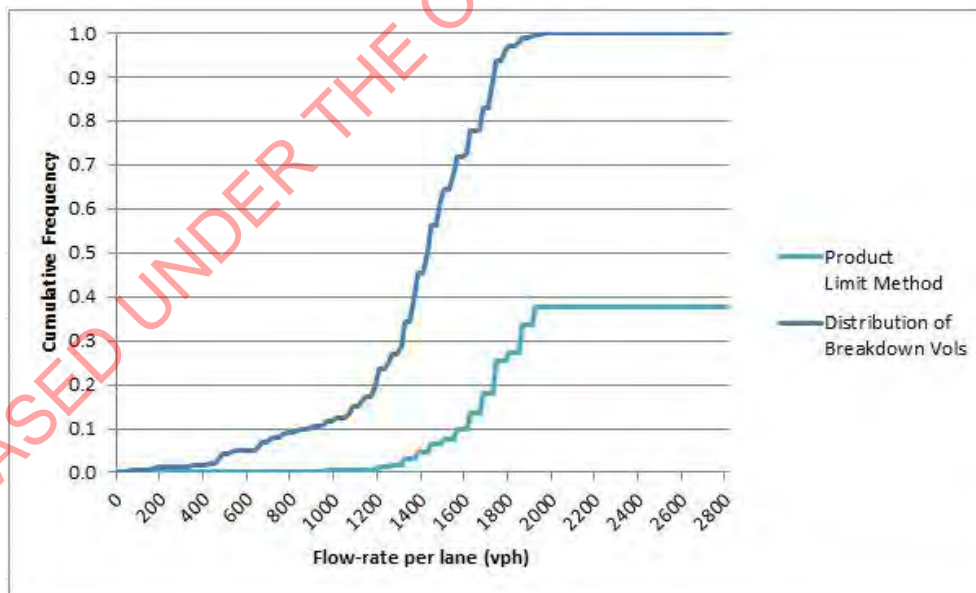

Figure 60 – Survival Function Generated by the Product Limit Method

However, the maximum value of the PLM function will be less than 1 unless the maximum observed value was, in fact, immediately followed by a flow breakdown event. Therefore, in many cases only a partial survival function is generated which terminates at  $F_c(q) < 1$  at its upper end, making estimate of the expected value of capacity problematic (as illustrated in Figure 60).



Reliability analysis provides a solution to the incomplete survival function. The Weibull distribution is frequently used in analysis of component failure rates and provides a good fit to the partial survival function provided by the PLM (Geistefeldt 2010). Visual calibration of the Weibull shape and scale parameters to fit the PLM data allows a good estimate of the expected value of capacity based on the 50th percentile value of the resulting Weibull curve (see Figure 61). Note that in the example of Figure 61 the expected value of capacity based on the Weibull curve is around 2,000 vehicles per hour per lane compared to around 1,450 vehicles per hour per lane based on the distribution of pre-breakdown flow rates.

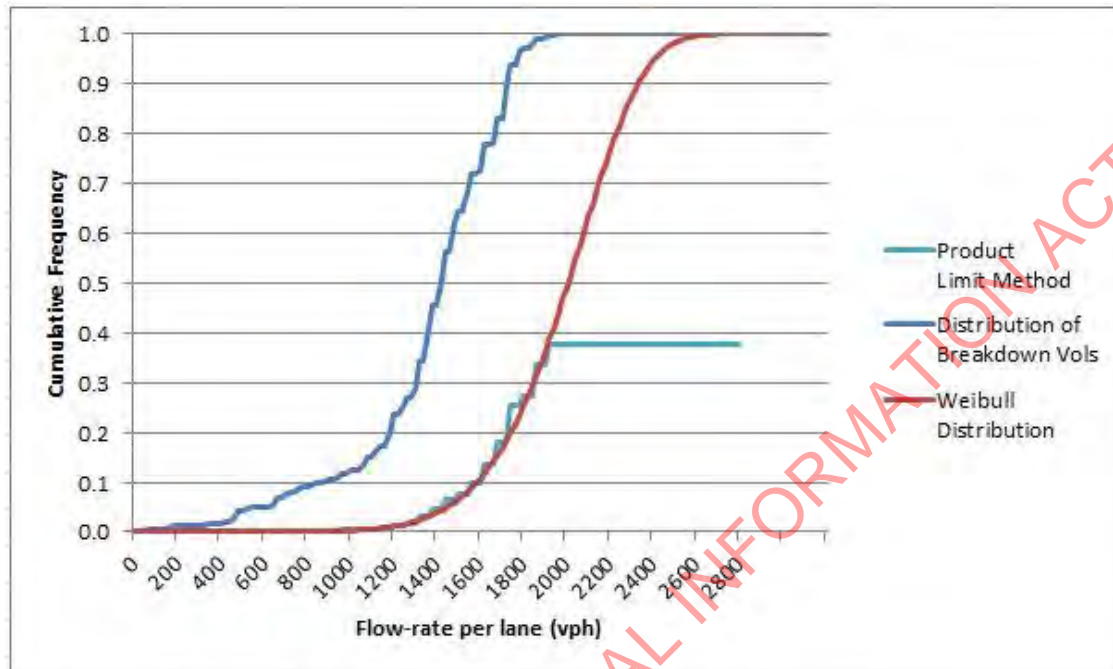

Figure 61 – Weibull Distribution Fitted to PLM data

The Product Limit Method has also been applied to post-breakdown (discharge) capacity flow distributions (Brilon et al 2005) although the logic here is flawed as comparison to life-time analysis shows: prior to flow breakdown traffic flow (comparable to age) keeps rising until flow breakdown (comparable to death) occurs. It is the rising of traffic flow to reach an unknown and variable capacity level (like aging towards an unknown point of death) that makes the logic of the analogy work. However, under post-flow breakdown discharge capacity conditions the flow rate varies but it is not continually rising (aging) towards a recovery from congestion but varying around an average value - meaning there is no reason to expect that flow rate immediately before the recovery from congestion is censoring higher values.

Observed data from multiple loop detector sites were used to quantitatively assess the capacity of the 3-lane configuration in each direction (see Figure 62). Data from the whole of 2019 was used. As the AHB remains in 4/4 configuration on weekends and Public Holidays, and for long periods during December and January only weekdays from February to November (excluding Public Holidays) were used – resulting in 210 days of data which was filtered to times when the AHB was in the 3-lane configuration in each direction (6am to 11am northbound, 3pm to 9pm southbound). The data was analysed at 5-minute granularity.

Volume – Occupancy graphs of 5-minute data for the 210 days indicated above were plotted for all detectors sites (lane data aggregated in each case), see Figure 62. Congested and non-congested conditions determined by visually estimating the critical occupancy values based on these plots (see vertical black line on each graph). Sensitivity testing of the critical occupancy values indicated the final results were insensitive to changes of +/- 0.02.

After filtering out any situations where the downstream detectors indicated congestion, cumulative pre-breakdown and post breakdown distribution curves were plotted for each direction (see Figure 63). Note that due to the differences in the volume values between the three northbound sites, the highest set of volume values (NB downstream site) were substituted in, to ensure capacity was not underestimated.

The Product Limit Method was then applied to the pre-breakdown distributions to generate a partial survival function and a Weibull curve fitted to the resulting plot (see Figure 63).

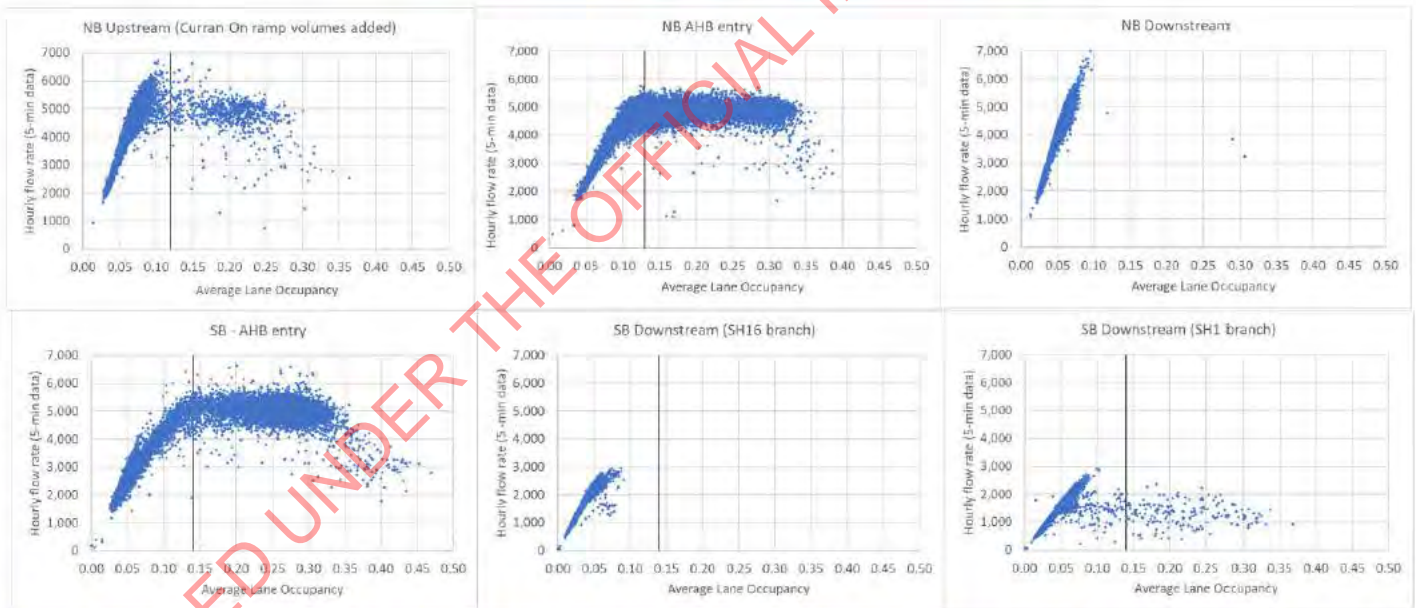
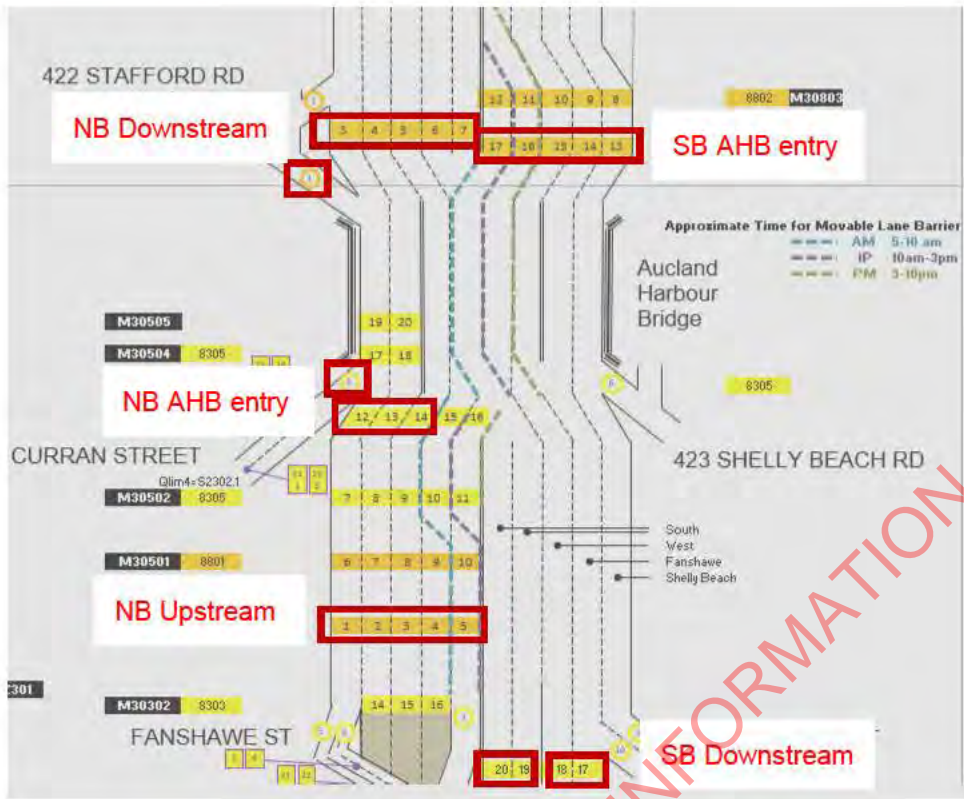
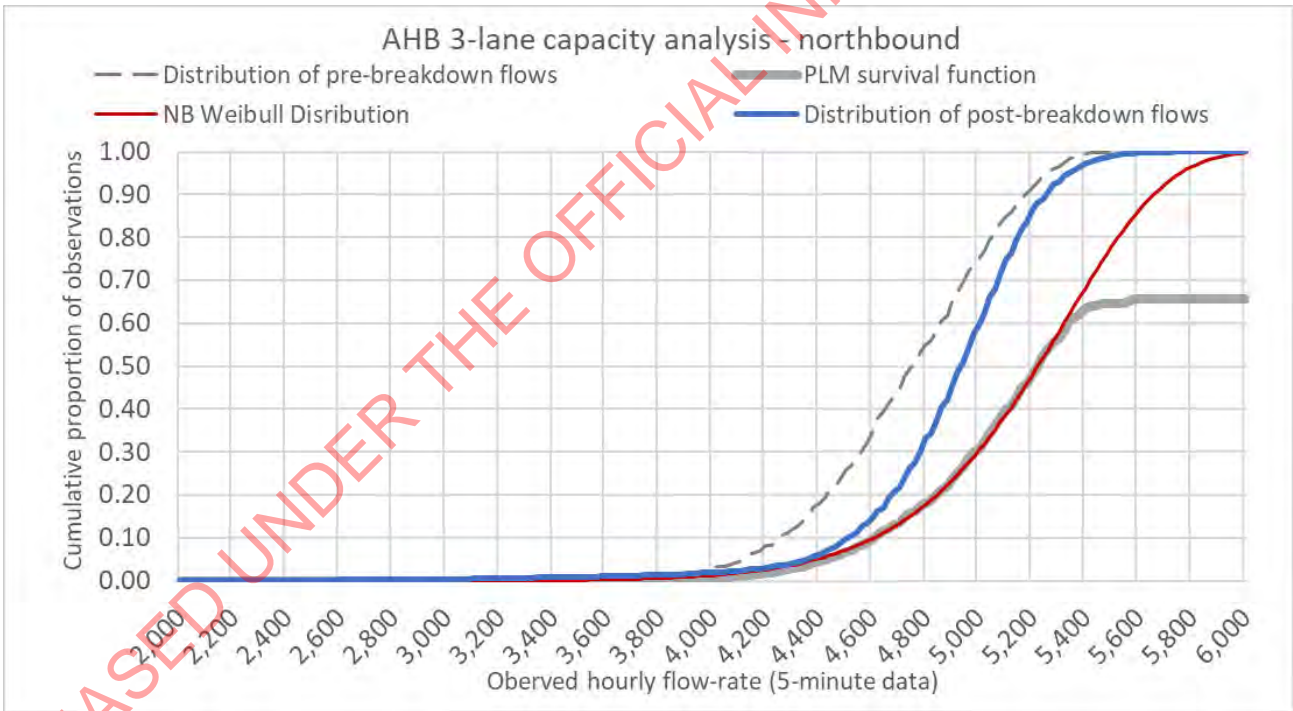
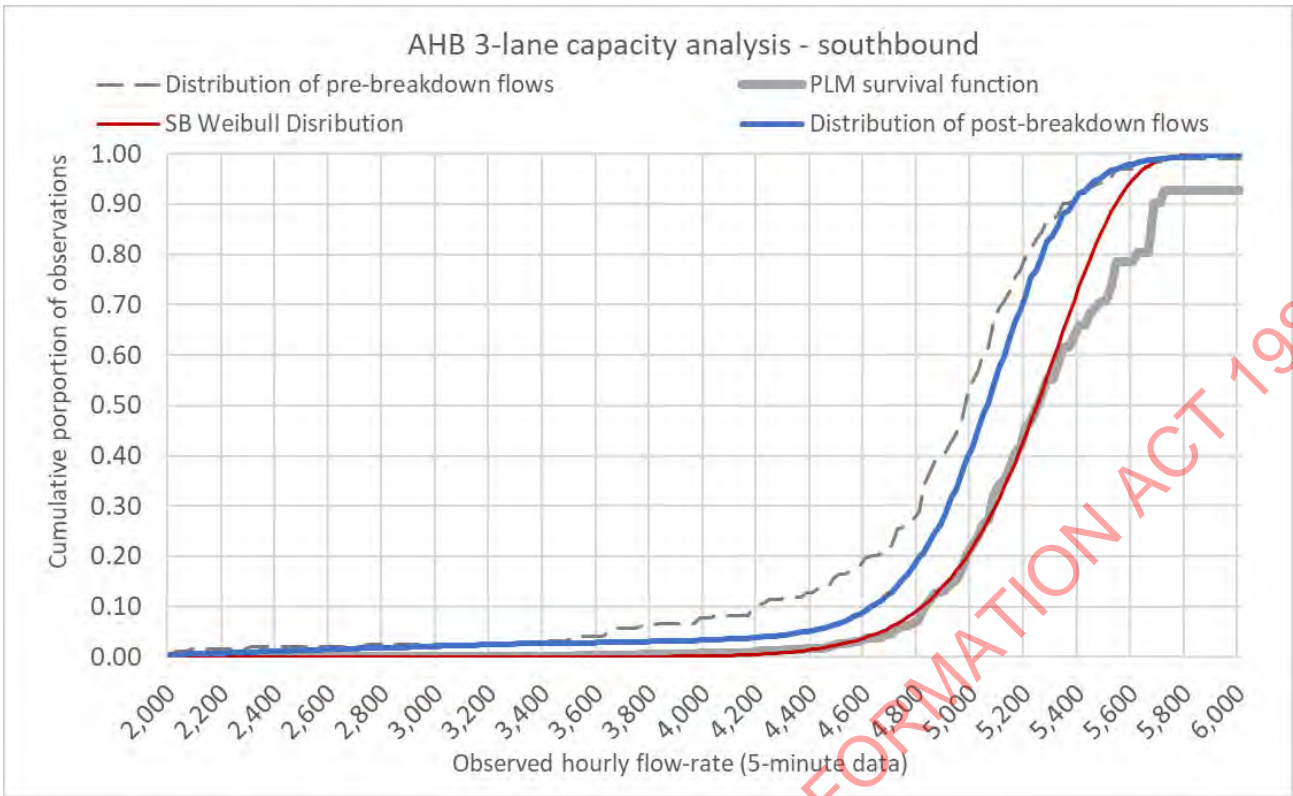

Figure 62 – Loop detectors used for AHB 3-lane capacity analysis (top). Volume-Occupancy plots of 5-minute data for 210 typical weekdays in 2019, 6am-11am NB (middle) and 3pm to 9pm SB (bottom)

RELEASED UNDER THE OFFICIAL INFORMATION ACT 1982



RELEASED UNDER THE OFFICIAL INFORMATION ACT 1982

Figure 63 – Cumulative distribution curves for: pre-breakdown flow rates, post-breakdown flow rates, Product Limit Method survival function and fitted Weibull curve (Southbound is top graph, northbound is bottom graph)

Given that the peak traffic arrival at the foot of the bridge in the 3-lane configurations (northbound in the AM peak and SB in the PM peak) exceeds the flowing (pre-breakdown) capacity of the 3-lane layout, flow breakdown becomes inevitable<sup>11</sup>. As a result, the congested (discharge) capacity that occurs following flow-breakdown is relevant to the analysis of wider traffic impacts over the course of a typical peak period, not just the pre-breakdown (flowing) capacity represented by the Weibull function.

The data indicate that over 210 days there were 194 breakdown events in the southbound direction, around one per day and inspection of the data confirms that on 155 of the 210 days once breakdown occurred at the beginning of the PM peak period there was no recovery until the end of the peak period. This reflects the nature of the bottleneck on the southbound approach to the bridge in 3-lane configuration: a right-hand land drop followed by an uncontrolled high volume on ramp and a section of intense weaving – meaning there is little means to directly and adaptively manage congestion to aid recovery once breakdown has occurred. When all the 5-minute periods across 2019 that were either pre-flow breakdown or congested are considered together, pre-breakdown flows only represented 2% of the time.

In the northbound direction there are 1,042 breakdown events over the 210 days, indicating an average of five cycles of breakdown and recovery over the average AM peak period. This also reflects the nature of the bottleneck in the northbound direction when the bridge is in the 3-lane configuration: a merge bottleneck at Curran Street on ramp affecting 2 of the 3 lanes, with the third lane physically segregated at the point of breakdown. There is a right and lane drop through St Mary's Bay, but the input of additional traffic further downstream at Curran Street means the merge becomes the more critical of the two. All upstream entry points are fully controlled – Curran Street is ramp metered and the Fanshawe Street ramp meter operates in the AM peak – this means the coordinated operation of the ramp metering system provides a degree of direct influence in response to flow breakdown events making recovery more likely. Only 18 out of 210 days consisted of a single breakdown event followed by persistent congestion where the discharge capacity distribution is solely relevant. In total when all the 5-minute periods across 2019 that were either pre-flow breakdown or congested are considered together, pre-breakdown flows only represented 17% of the time.

A further consideration relevant to the determination of 3-lane capacity for modelling purposes is the average throughput achieved at the bridge bottleneck during an entire congested peak period. While the 50<sup>th</sup> percentile (expected value) of the post-breakdown curve reflects this – higher or lower percentiles of this curves do not since it treats each 5-minute period as independent. In other words, for the 90<sup>th</sup> percentile value of the post-breakdown curve to represent congested throughput over the peak every 5-minute period for several hours would need to achieve the 90<sup>th</sup> percentile level.

Since the modelling is concerned with determining the size of the traffic backlog that forms and then clears in each direction over a peak for a specific demand level (including how far upstream this backlog reaches and what other bottlenecks may be impacted by it), the distribution of the bottleneck throughput achieved over the entire congested period becomes important in setting an appropriate capacity level in the model. Figure 64 and Figure 65 below uses data from May 2019 to display time-space corridor congestion heatmaps in the top panels – with the solid black vertical line in each case illustrating the typical period over which a backlog of congested traffic formed when the AHB was in a 3-lane configuration.

The bottom panels of Figure 64 and Figure 65 display the cumulative curves for three different measures of capacity for the 3-lane configuration of the AHB:

- Pre-breakdown (flowing) capacity (red line)
- Post-breakdown (congested) capacity (blue line)
- Congested peak total 2-hour throughput (black dotted line)

As expected, the curve of the 2-hour peak throughput coincides with the post-breakdown (congested) capacity curve at the 50<sup>th</sup> percentile (expected) value, but in each case gives a tighter overall distribution (narrower range).

Overlaid on each graph is the capacity range used in CTM base model for the AHB when in 3-lane configuration (light blue vertical band). In both cases the CTM capacity bands cover a broad range of the post breakdown and 2-hour congested throughput curves above the 50<sup>th</sup> percentile and a substantial range of the pre-breakdown curves below the 50<sup>th</sup> percentile. Note that in both cases the modelled range covers the 90<sup>th</sup> percentile of the 2-hour congested throughput curve.

Given that the capacity analysis shows that when demand has reached the capacity of the 3-lane bridge bottleneck 98% of the time in southbound direction and 83% of the time in the northbound direction it operates under congested capacity conditions, the capacity ranges adopted in the CTM for the 3-lane configuration of the AHB seem appropriate.

<sup>11</sup> Arrival demands exceed 3-lane capacity northbound in the AM peak and southbound in the PM peak. The Co-ordinated ramp metering system is unable to manage arrival demands to below this due to a combination of uncontrolled entry points upstream (Onewa Road) and insufficient queue storage collectively at the relevant upstream on ramps.

Northern Motorway southbound

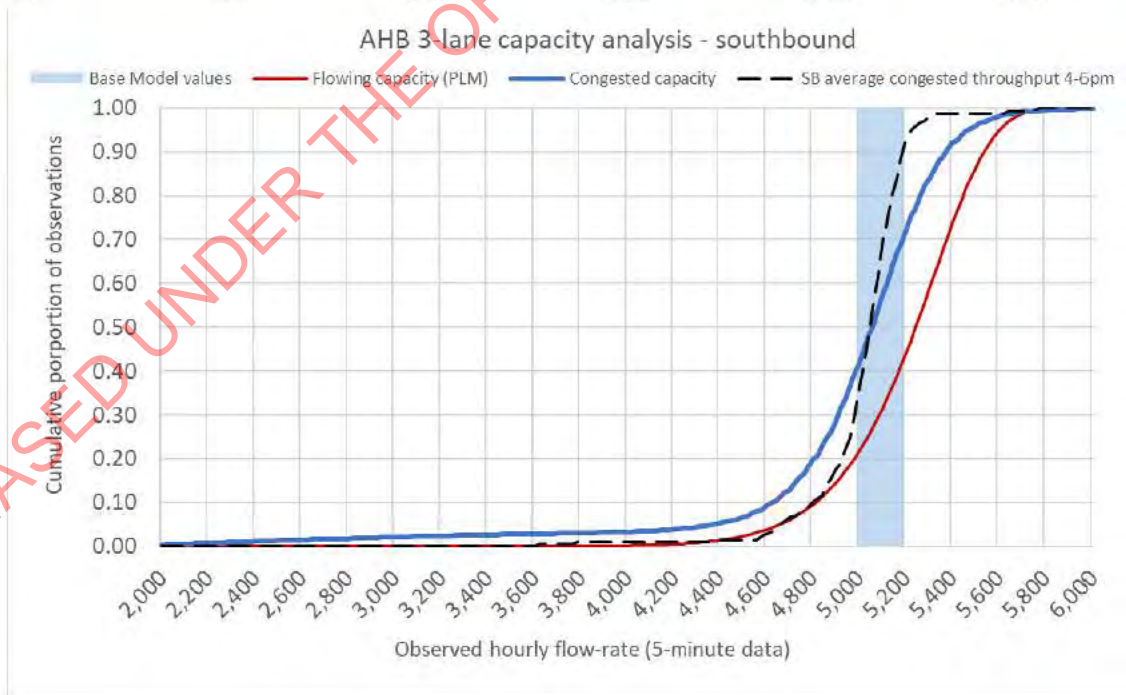
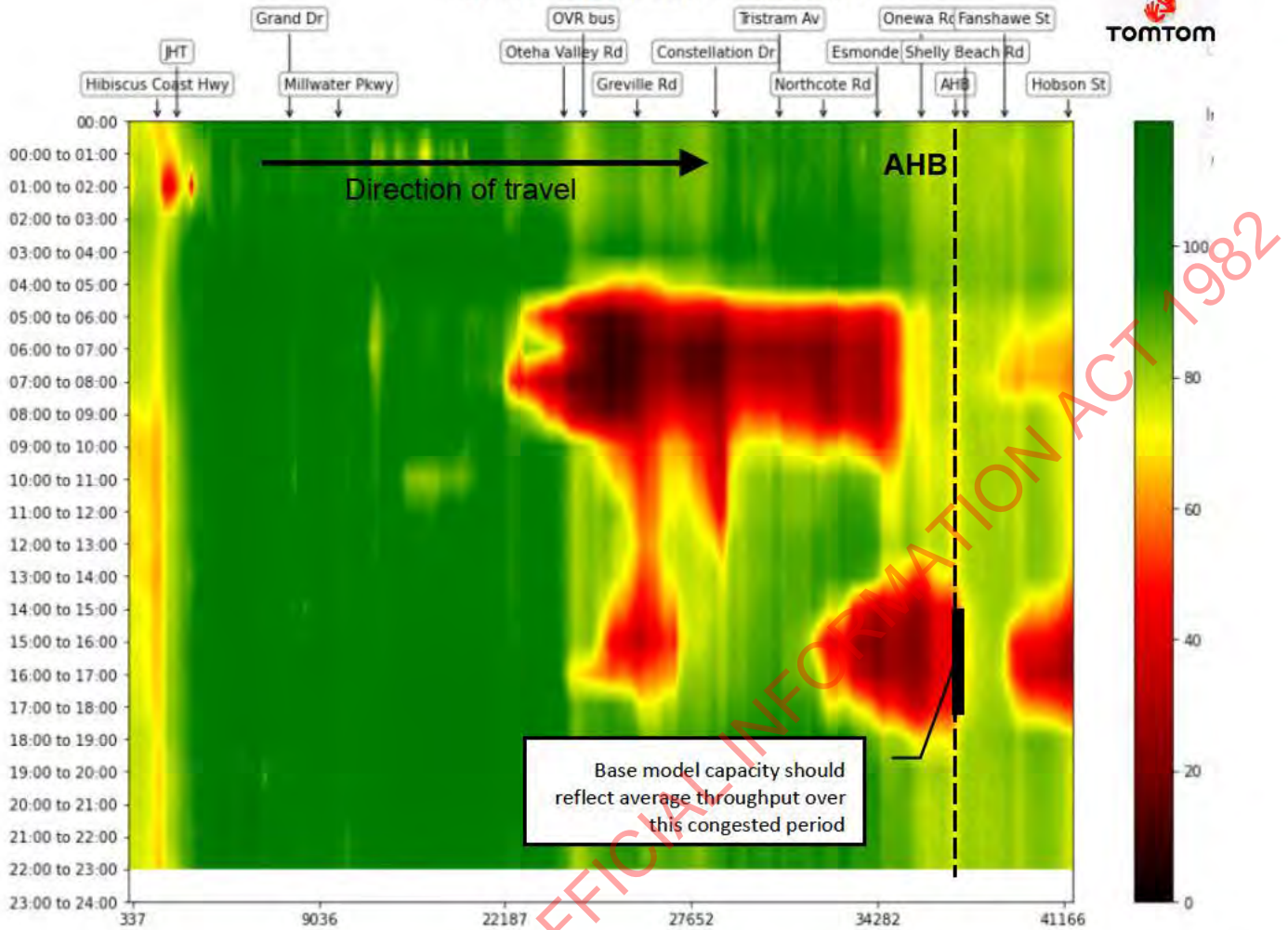

Figure 64 – SH1 southbound corridor congestion heatmap based on May-2019 data (top panel); Cumulative distribution curves for AHB southbound 3-lane capacity: flowing capacity, congested capacity and average throughput during congestion - overlaid with capacity range used in CTM (bottom panel)

Northern Motorway northbound

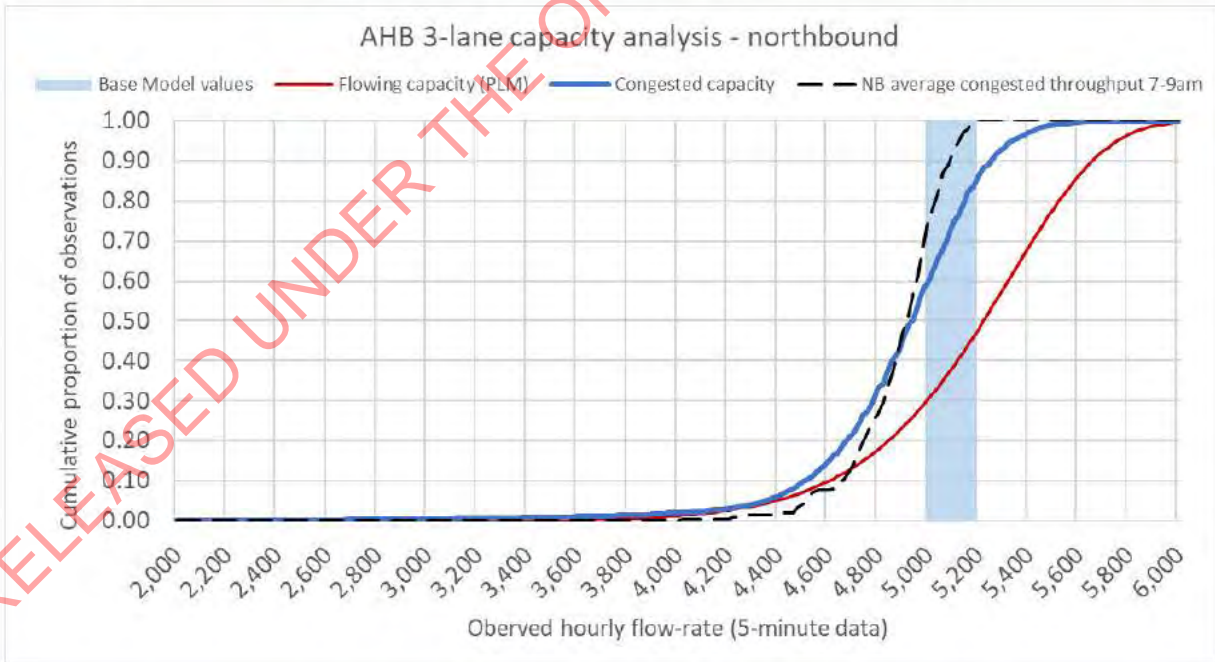
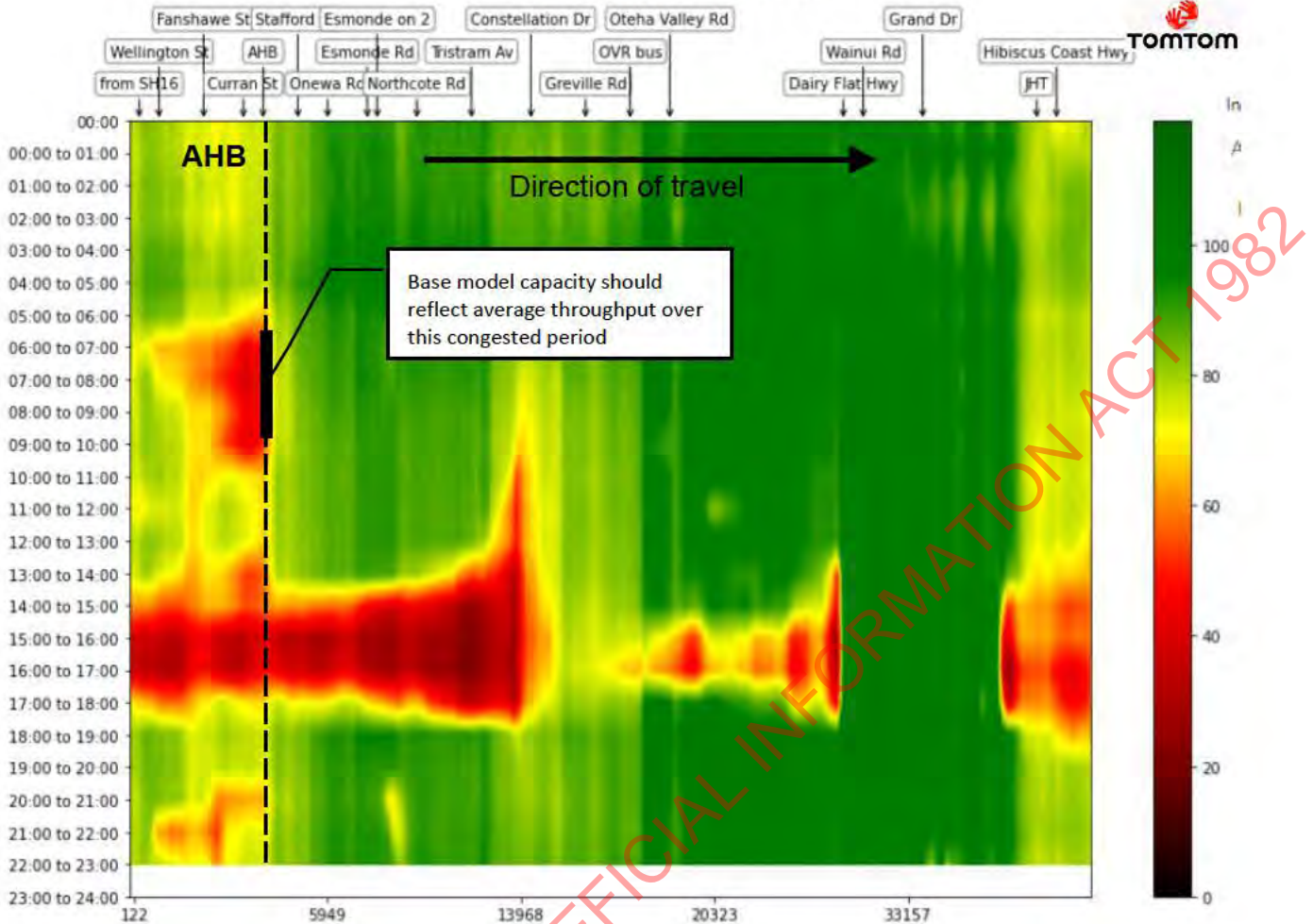

Figure 65 - SH1 northbound corridor congestion heatmap based on May-2019 data (top panel); Cumulative distribution curves for AHB southbound 3-lane capacity: flowing capacity, congested capacity and average throughput during congestion - overlaid with capacity range used in CTM (bottom panel)

## References

Wu, N., (2004) *Determination of Stochastic Bottlenecks Capacity on Freeways and Estimation of Congestion Probabilities*, Proceedings of the International Conference on Traffic and Transportation Studies, Dalian, China, Aug. 2-4 2004, Science Press, Beijing.

Gaffney, J., Hall, M., Burley, M., & Zurlinden, H. (2019). *VicRoads Managed Motorway Design Guide, Volume 1: Managed Motorway Role, Traffic Theory and Science for Optimisation, Part 3: Motorway Capacity Guide*. Kew: VicRoads.

Brilon, W., Geistefeldt, J., Regler, M. (2005) *Reliability of Freeway Traffic Flow: A stochastic Concept of Capacity*, Proceedings of the 16th International Symposium on Transportation and Traffic Theory, pp. 125 – 144, College Park, Maryland, July 2005, ISBN 0-08-044680-9

Geistefeldt, J. (2010) *Consistency of Stochastic Capacity Estimations*, Transportation Research Record: Journal of the Transportation Research Board, No. 2173, Transportation Research Board of the National Academies, Washington, D.C., 2010, pp. 89–95. DOI: 10.3141/2173-11

RELEASED UNDER THE OFFICIAL INFORMATION ACT 1982

## APPENDIX E – SUMMARY OUTPUTS FROM TIER TWO AND THREE ASSESSMENTS

Distribution of impacts by time and location are shown in visual summaries on following pages comprising:

- Network overview congestion heatmaps for AM peak (left side of the page) and PM peak (right side of the page) for each option (based on P50 speed for each location over the 3-hour peak). This includes an insert graph of total on ramp queues across the network in both peaks compared to typical values for 2019.
- Corridor congestion heatmaps for each option over whole day (right side of the page) compared to typical congestion patterns for the same corridor from 2019 (left side of the page). For the one lane options where impacts are confined to the SH1 corridors upstream of the AHB only heatmaps for these corridors are shown. For the 2-Lane options where impacts are also spread across the WRR (SH16 and SH20) these heatmaps are shown on the following page

RELEASED UNDER THE OFFICIAL INFORMATION ACT 1982



Tier 2: 2-Lane Option – Best Case (Minimum Demand – Maximum Capacity)

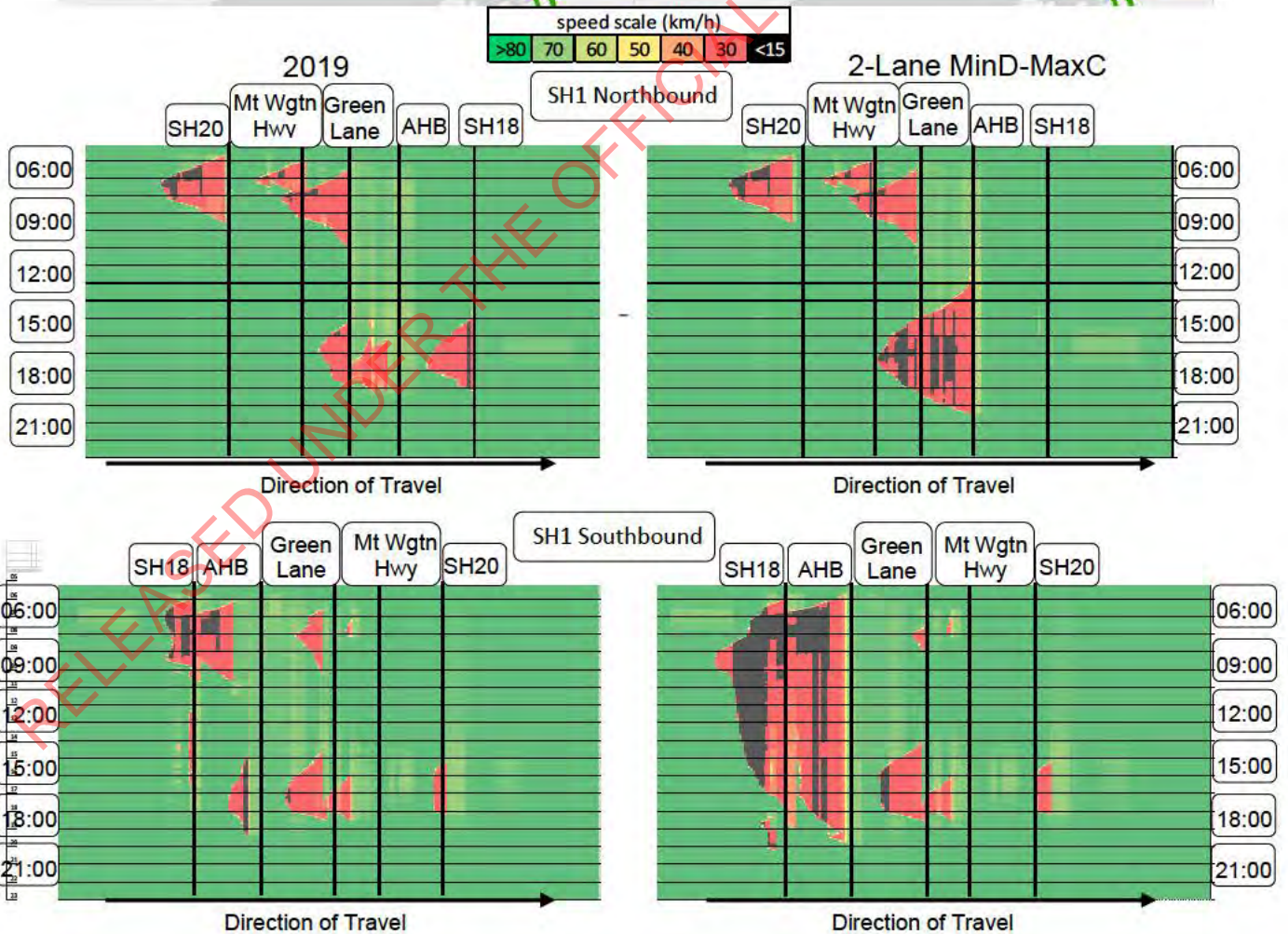
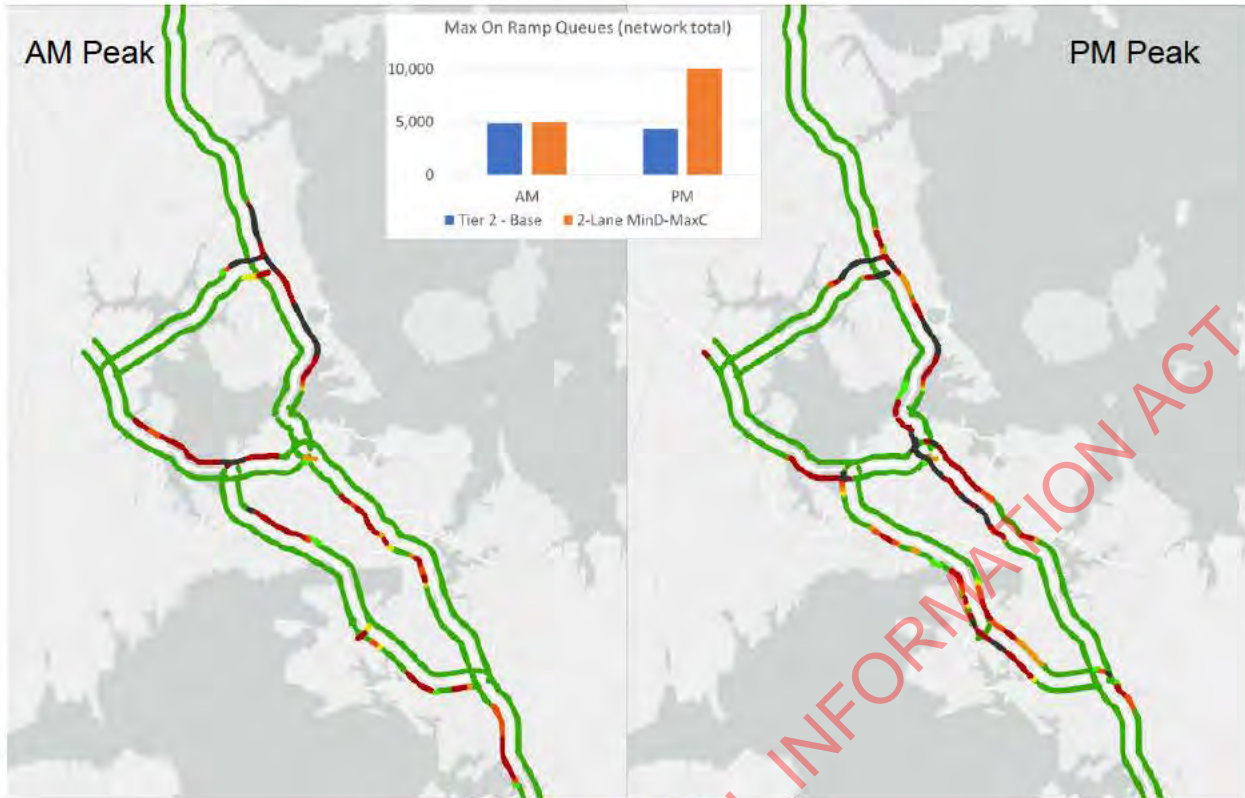

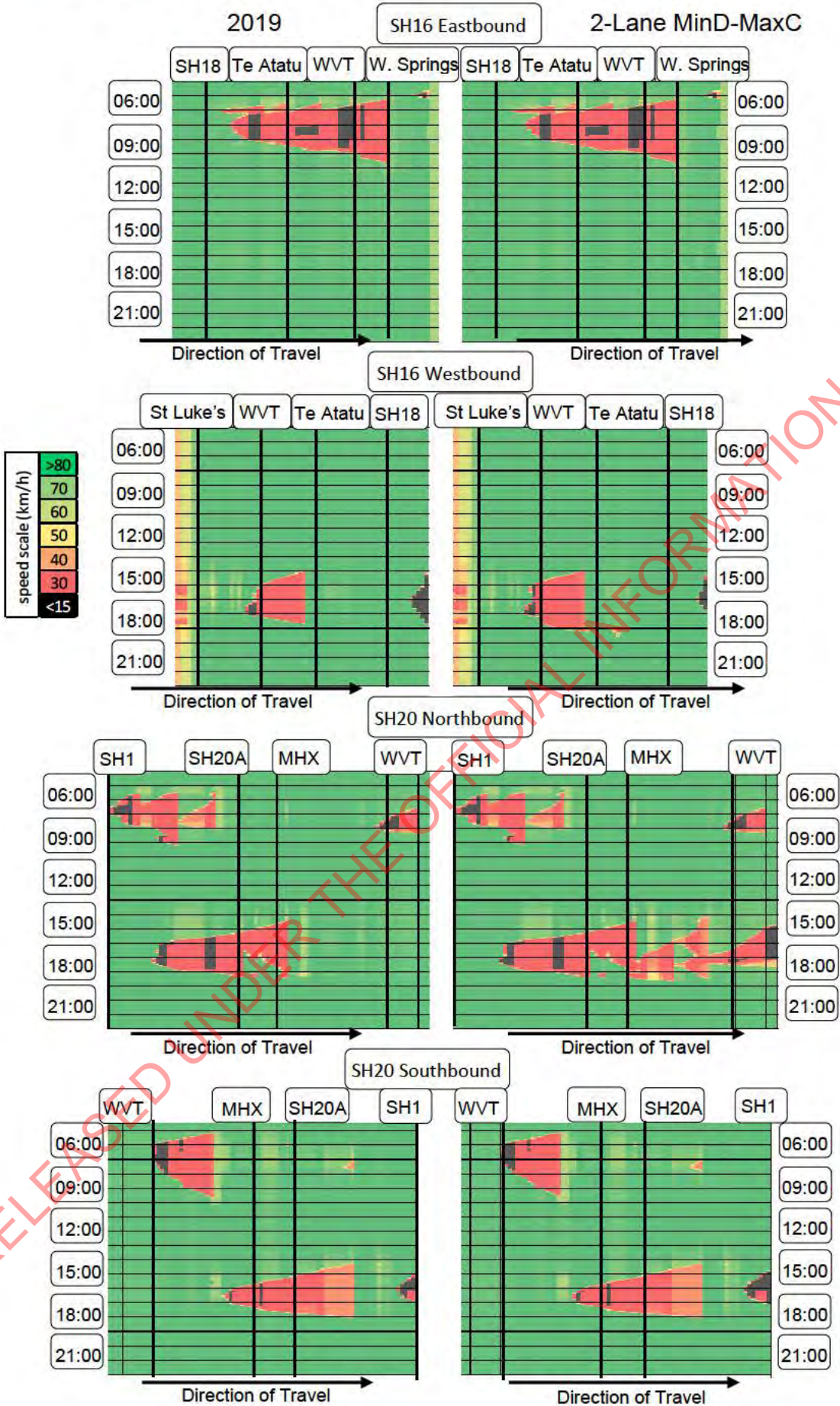

Tier 2: 2-Lane Option – Worst Case (Maximum Demand – Minimum Capacity)

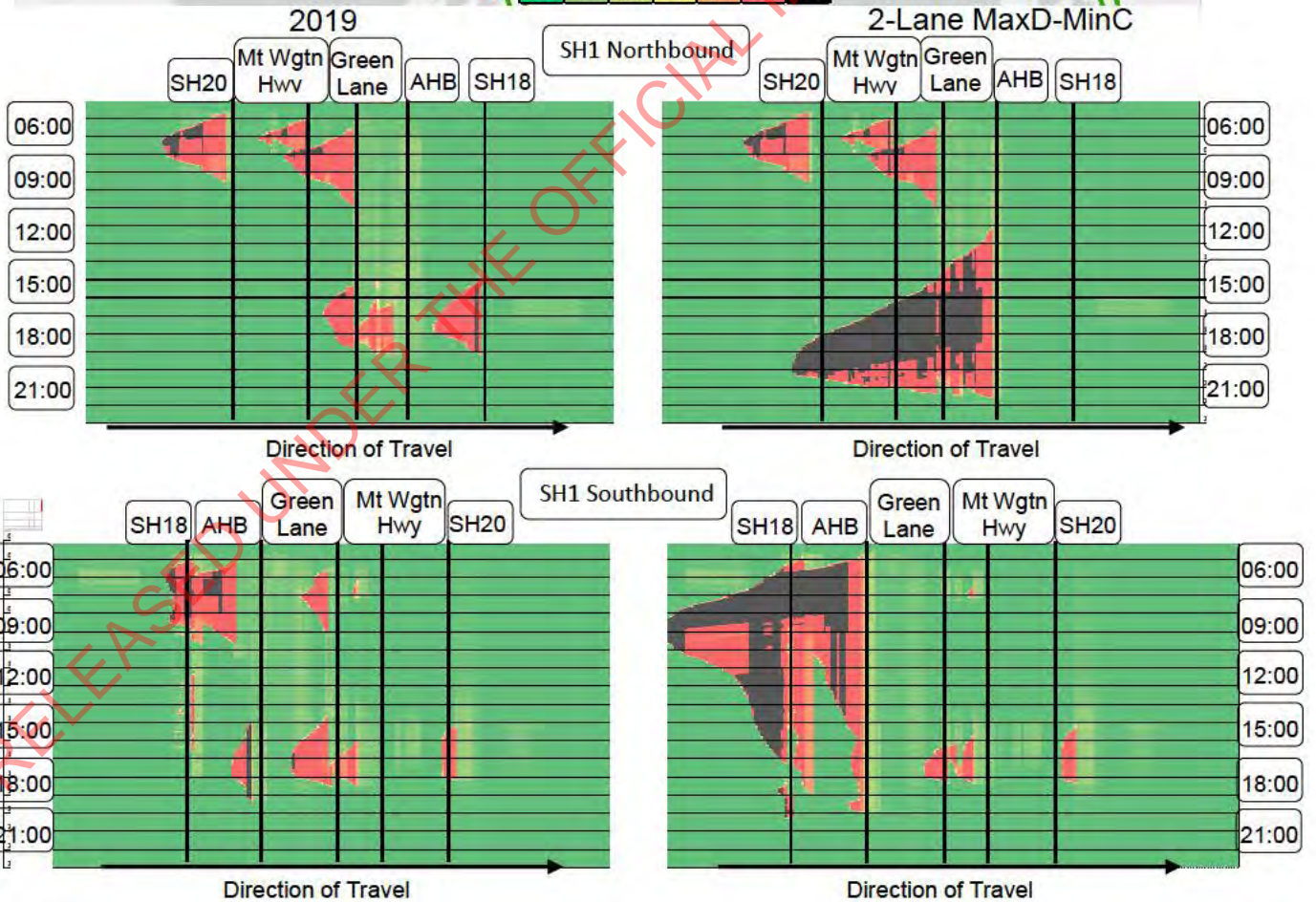
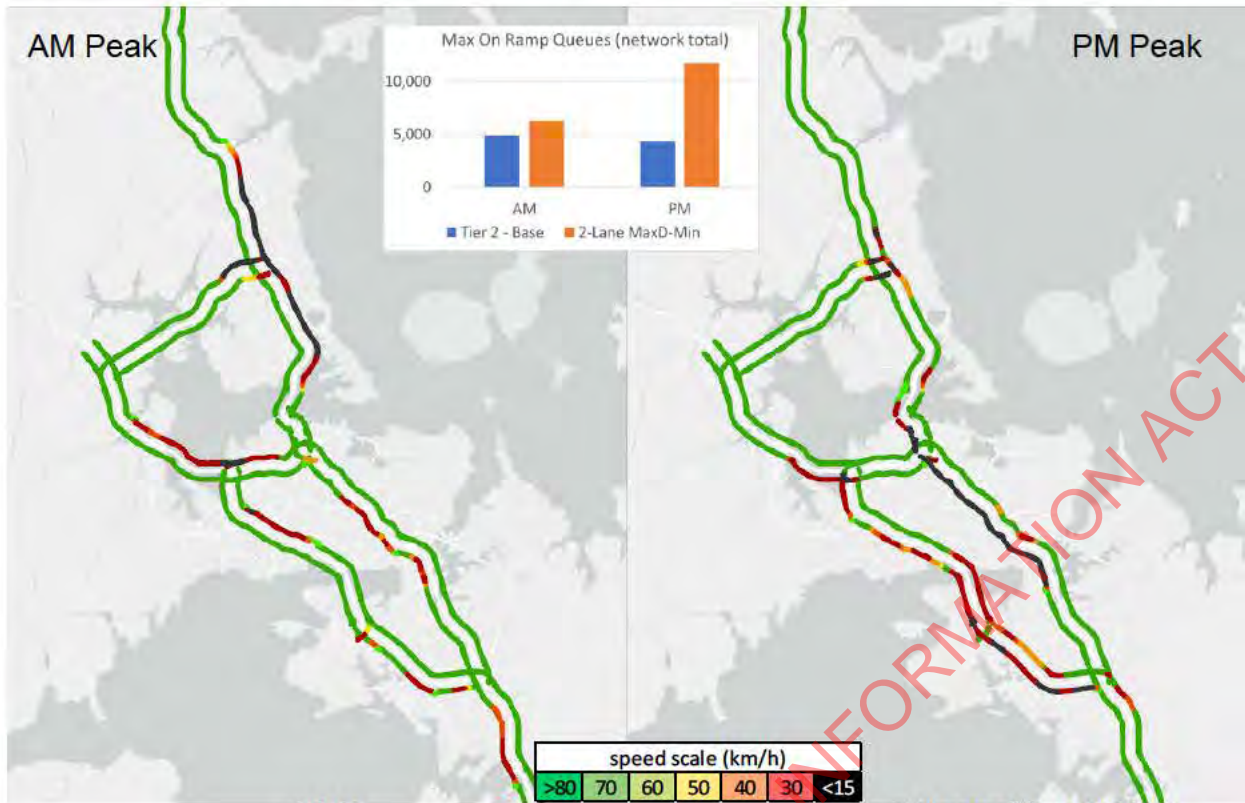

Tier 2: 2-Lane Option – Worst Case (Maximum Demand – Minimum Capacity)

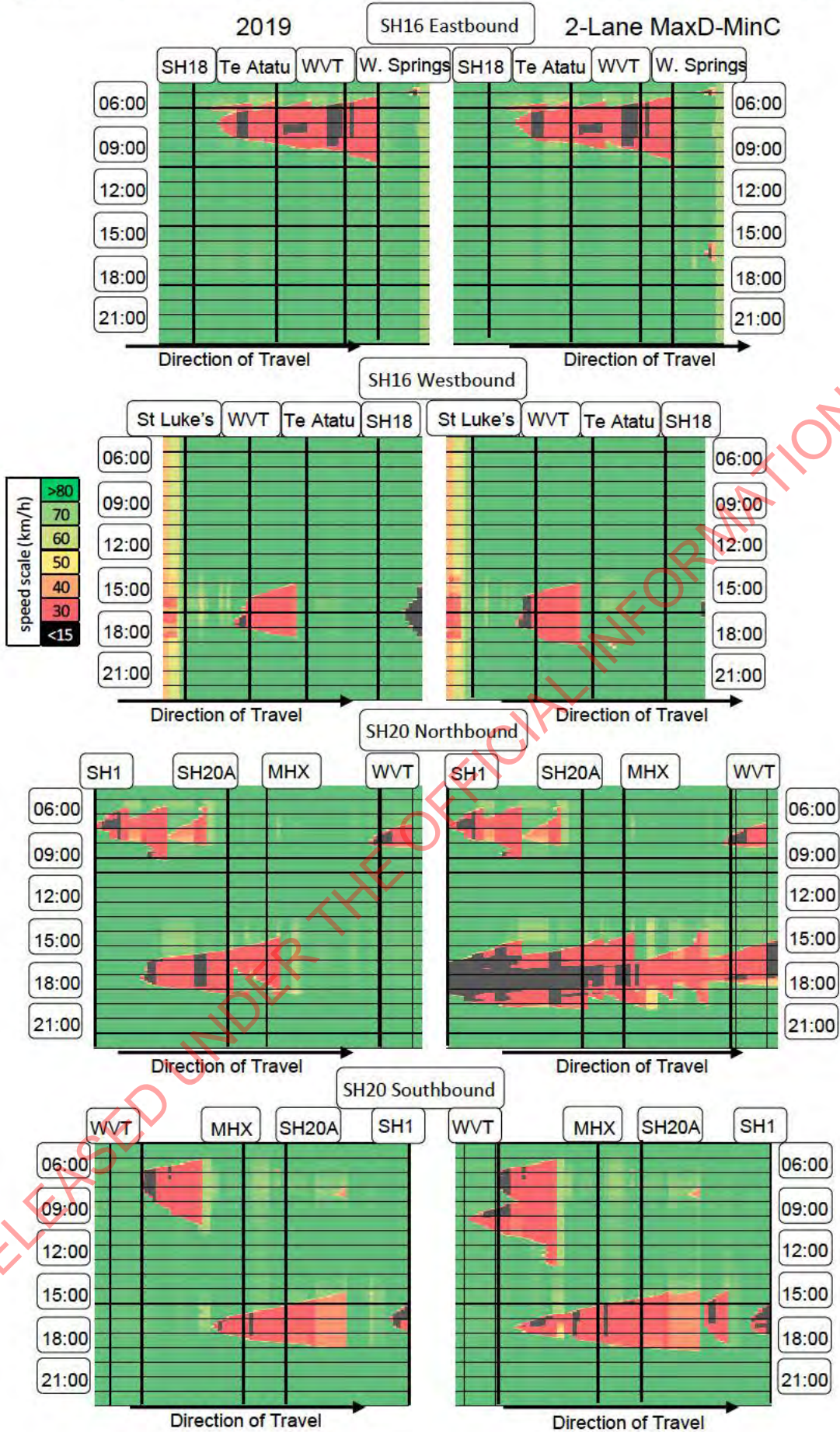

Tier 2: 1-Lane Option – Best Case (Minimum Demand – Maximum Capacity)

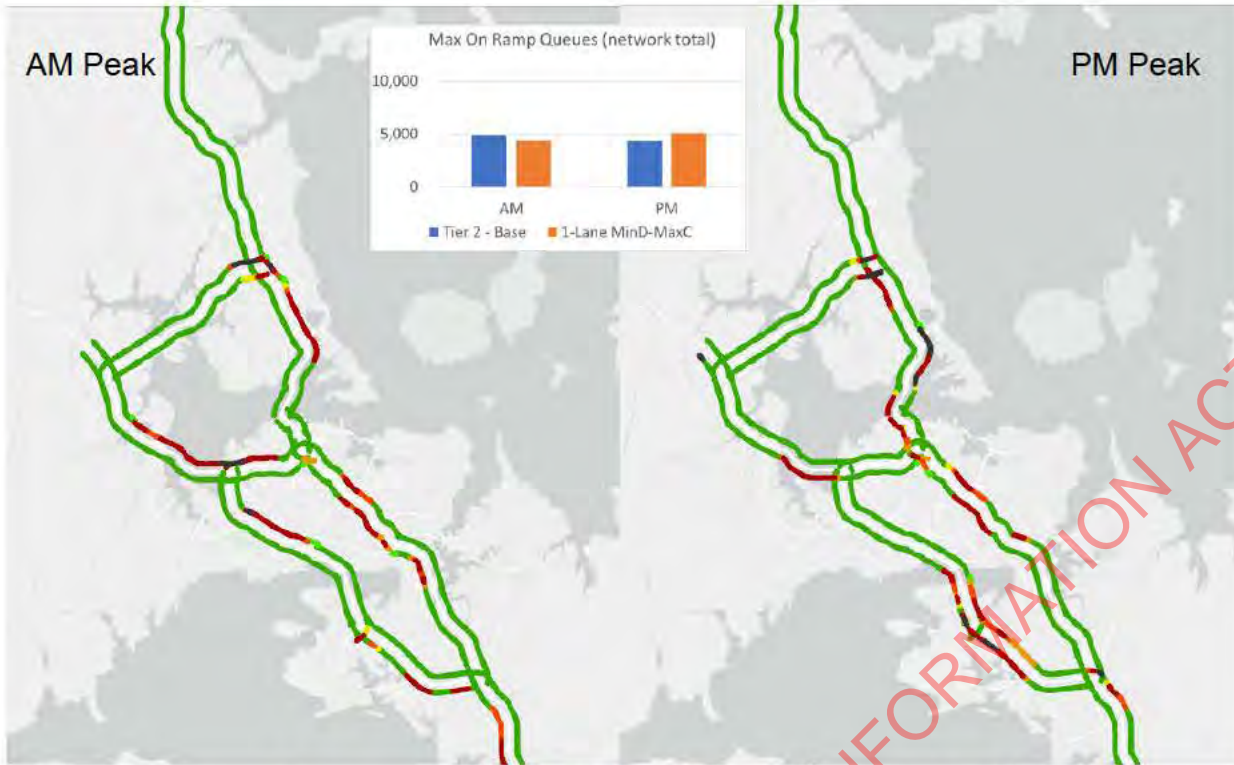

2019



1-Lane MinD-MaxC

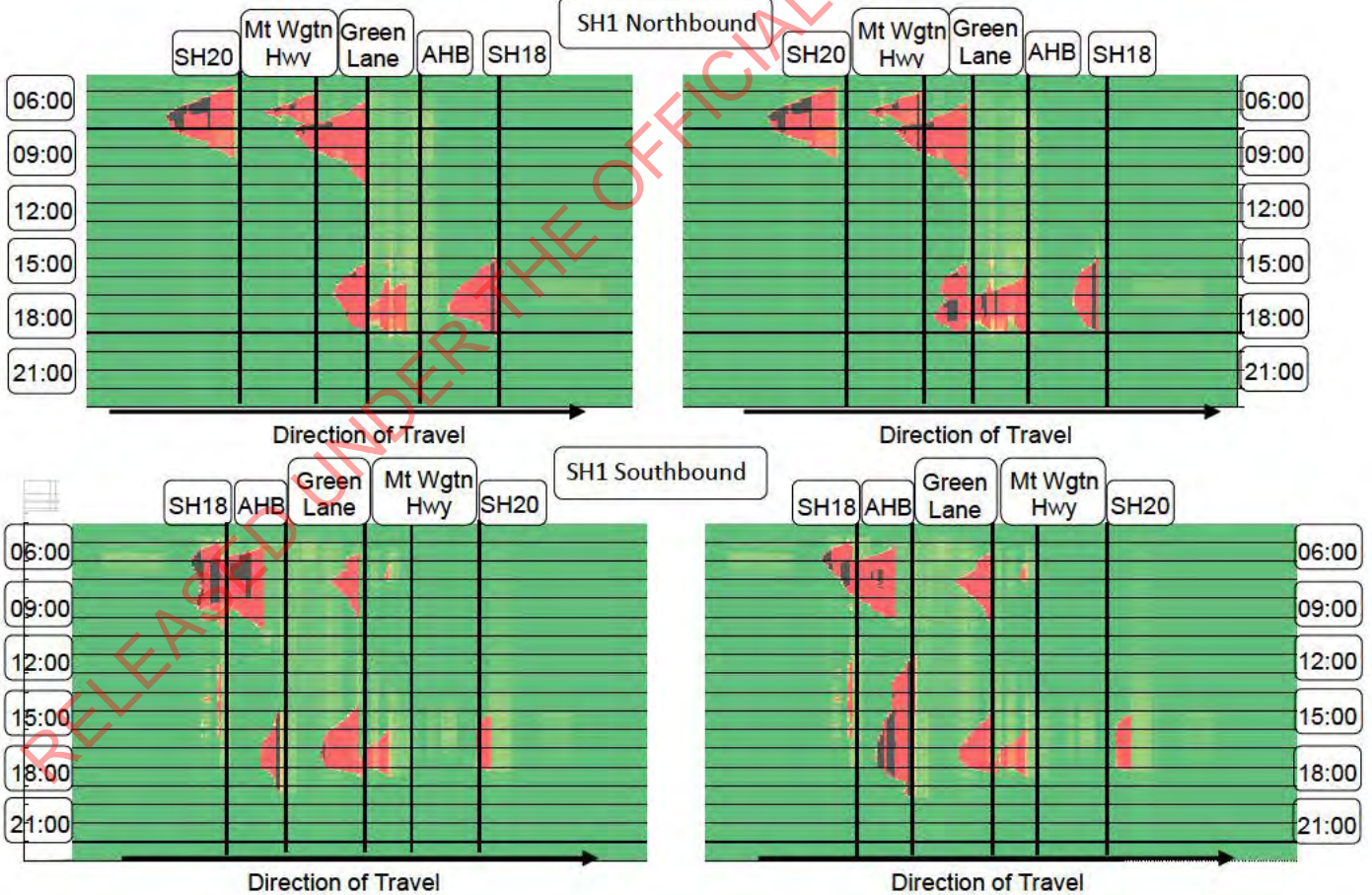

Tier 2: 1-Lane Option – Worst Case (Maximum Demand – Minimum Capacity)

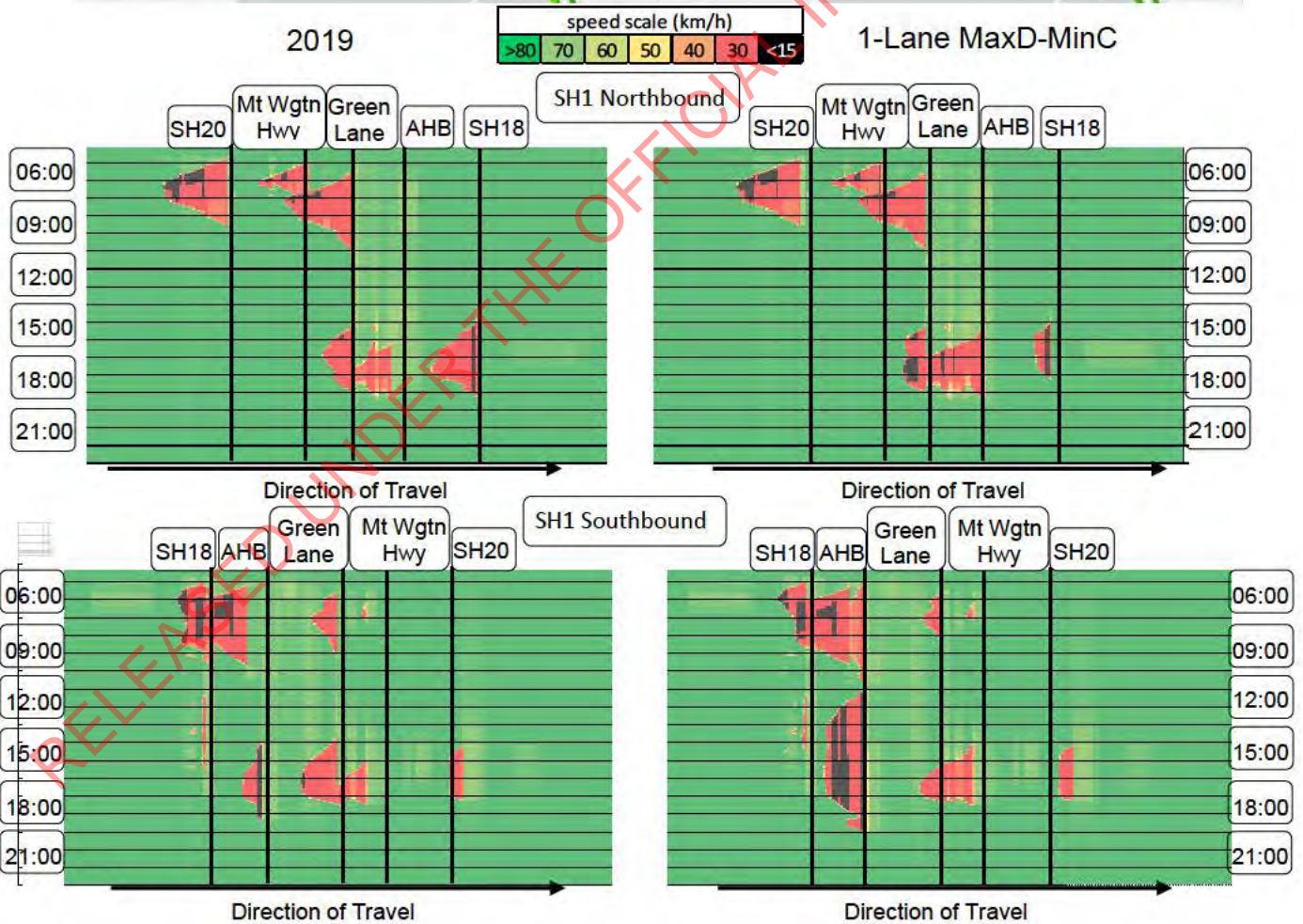
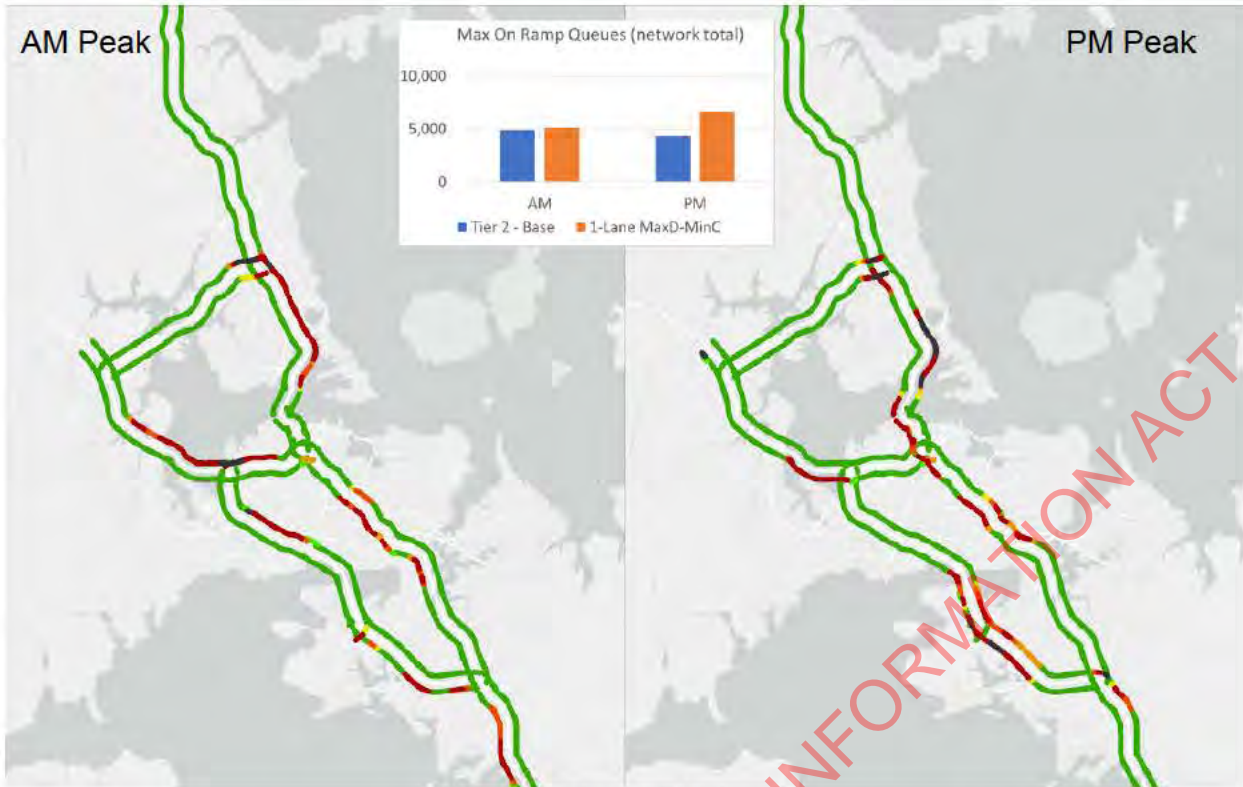

Tier 3: 1-Lane Option – Worst Case (Maximum Demand – Minimum Capacity)

Adjusted P50 demands + Level 1 mode shift + Peak Spreading

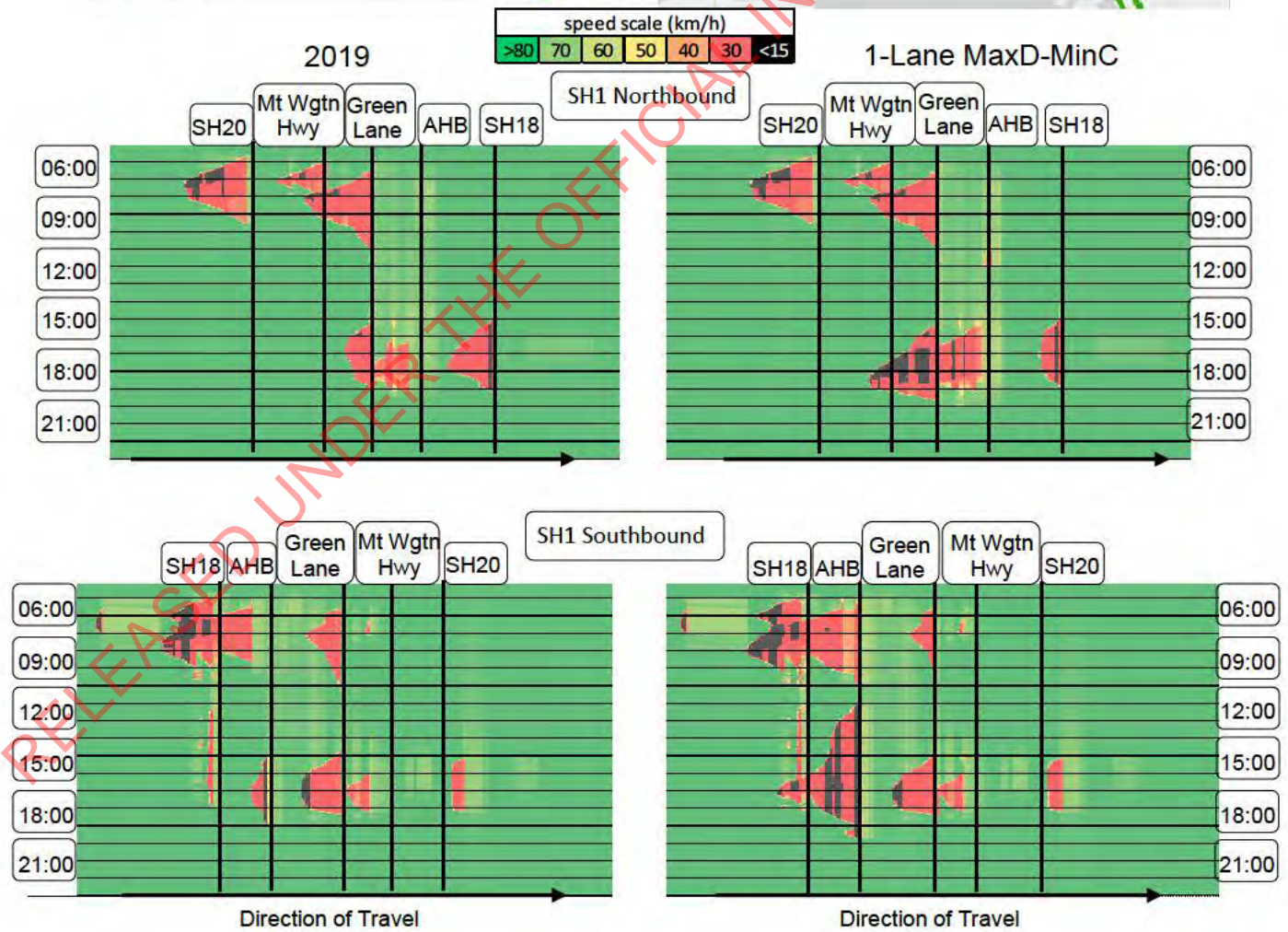
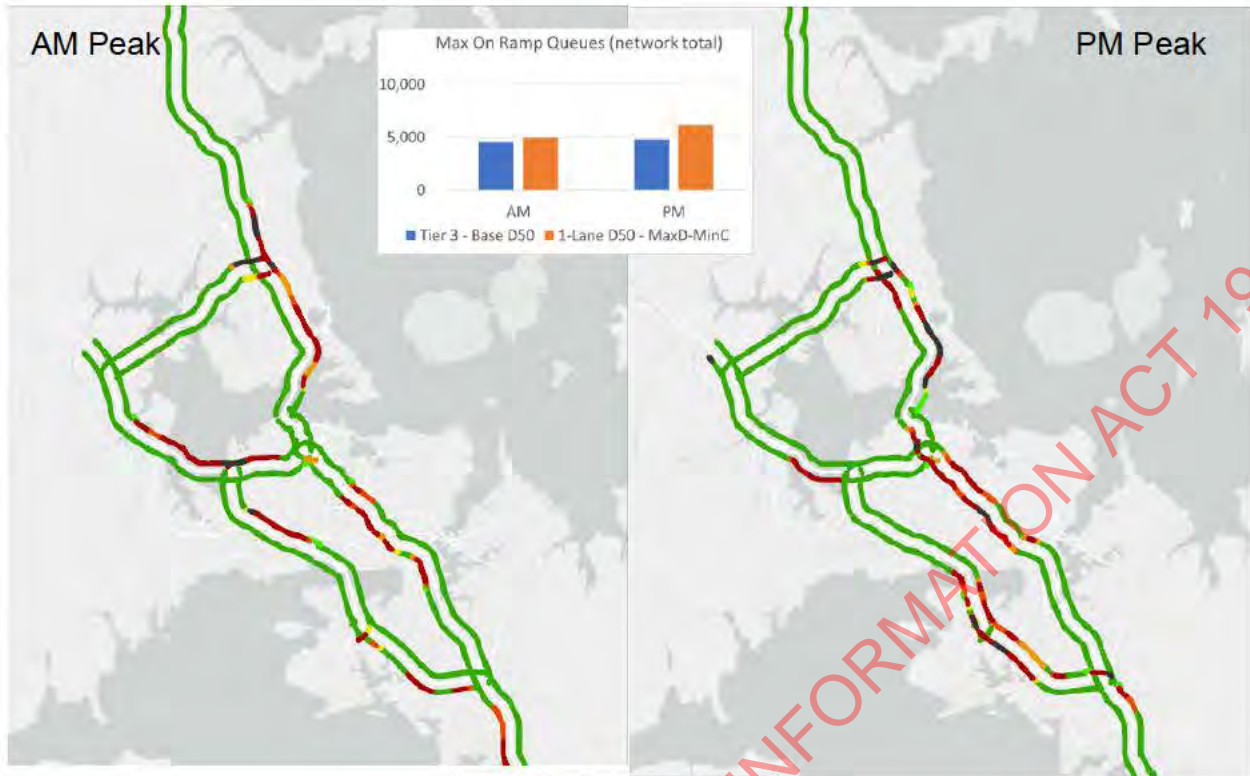

Tier 3: 1-Lane Option – Best Case (Minimum Demand – Maximum Capacity)

Adjusted P50 demands + Level 2 mode shift + Peak Spreading

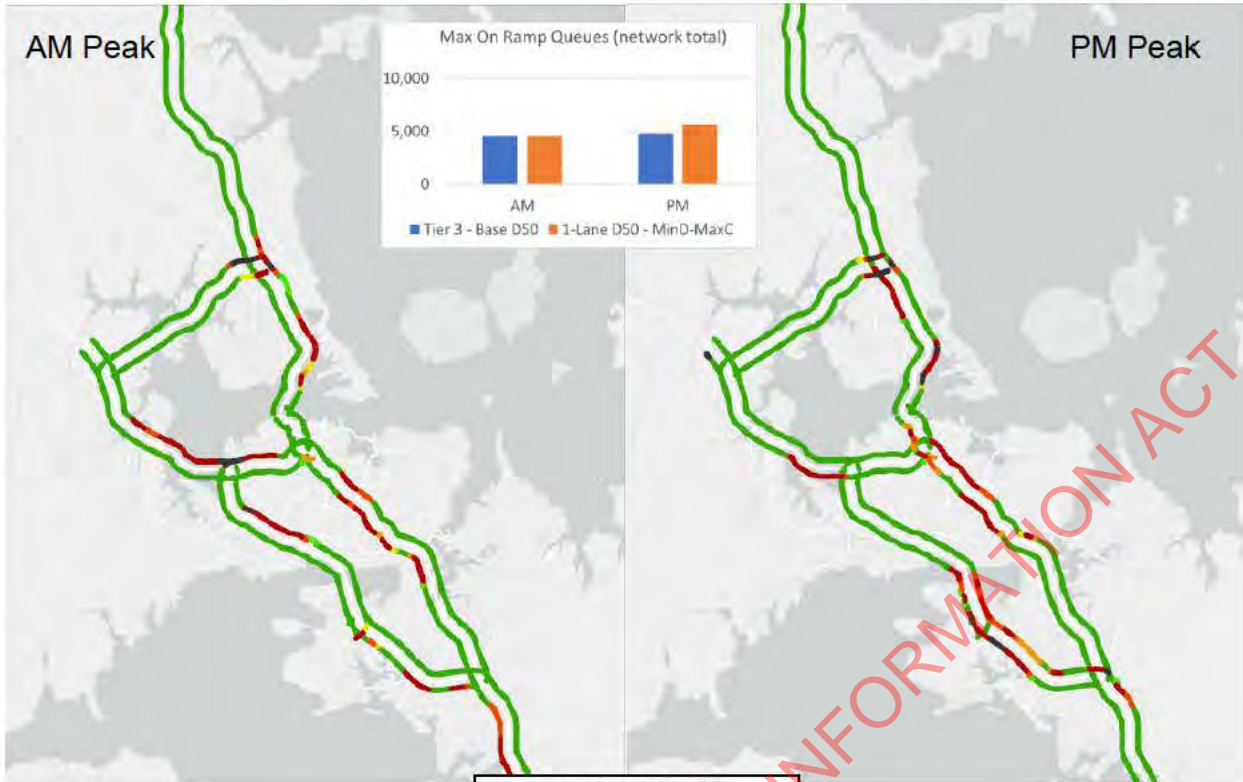



**Tier 3: 1-Lane Option – Worst Case (Tier-2 1-Lane Minimum Demands – Minimum Capacity)**

**Adjusted P90 demands + Level 3 mode shift + Peak Spreading**

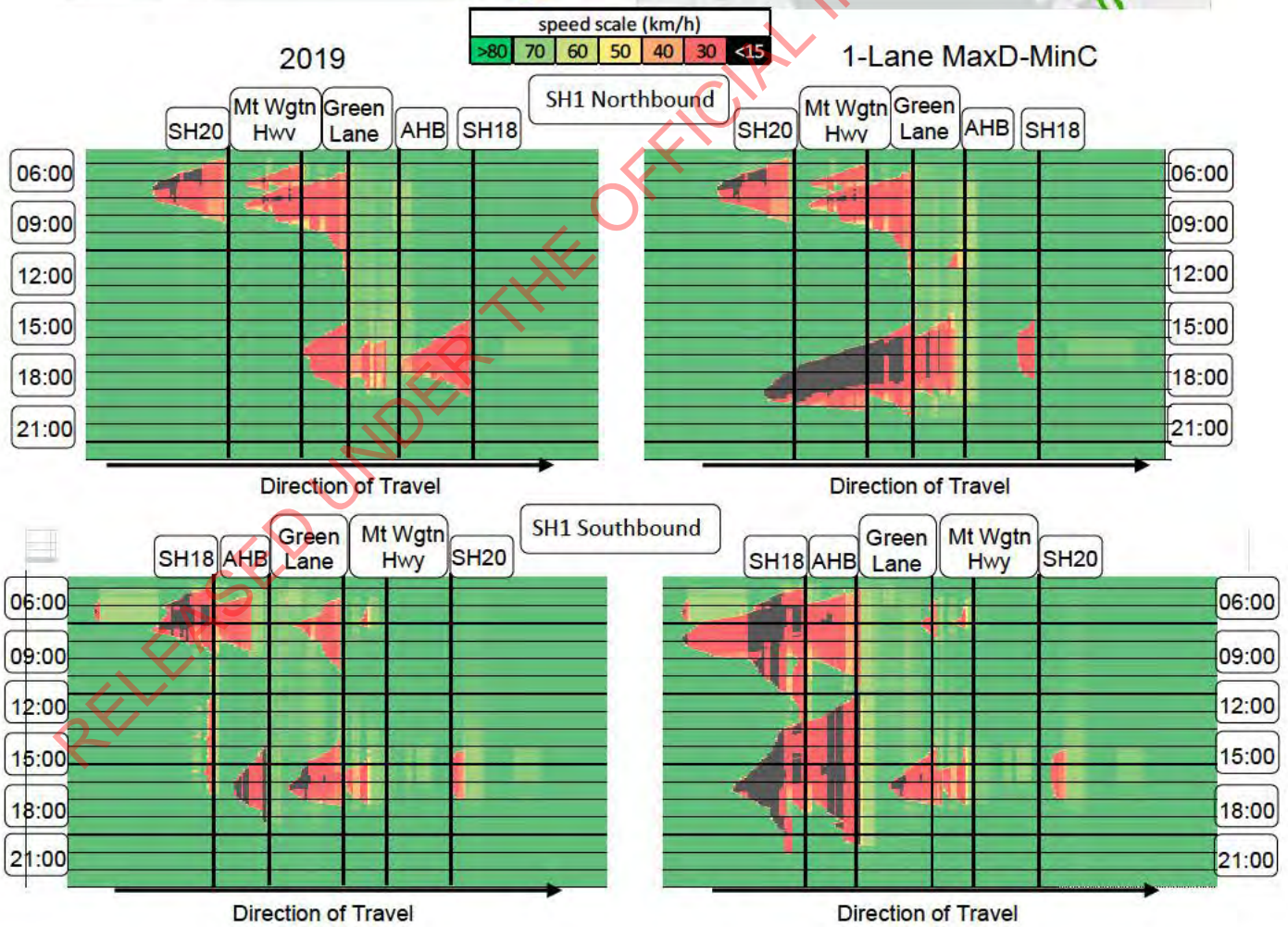
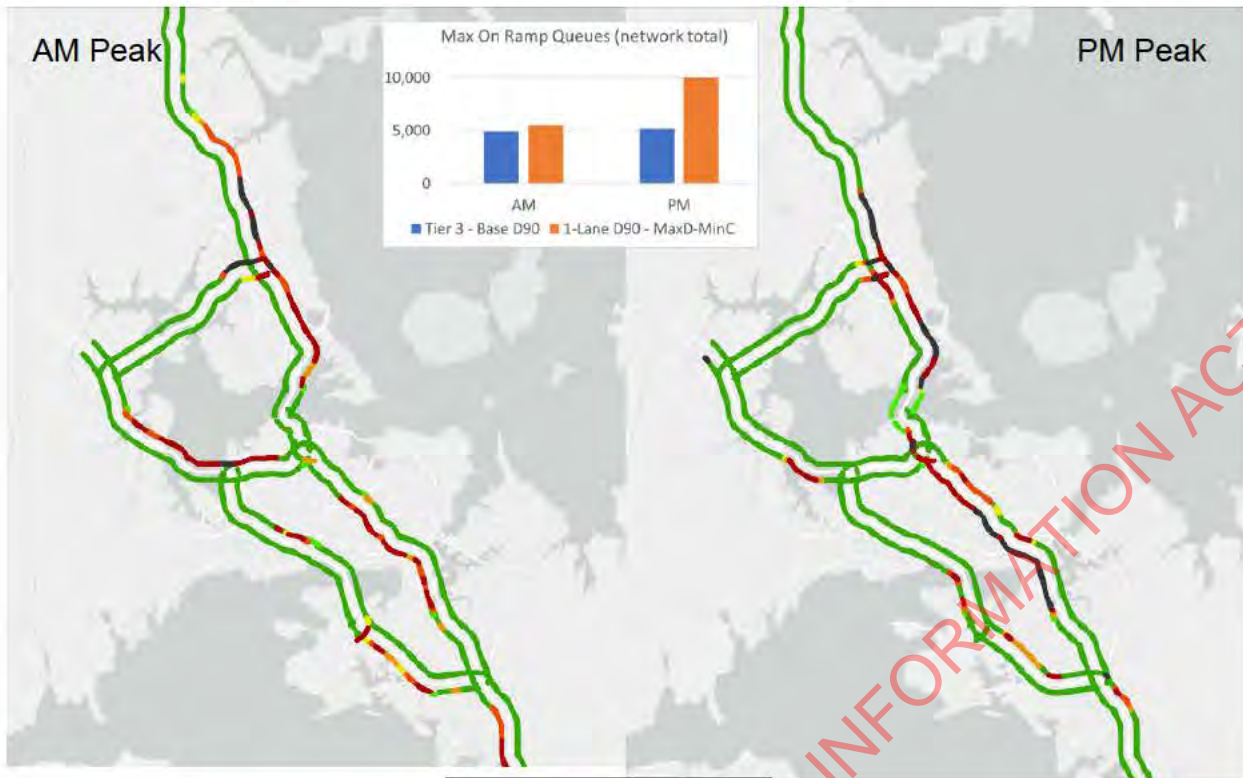

Tier3: 1-Lane Option – Best Case (Tier-2 2-lane Max. Demands, excl re-routing – Max. Capacity)

Adjusted P90 demands + Level 3 mode shift + Peak Spreading

